



*Big Picture*  
**BIBLE**  
**CRAFTS**

**101**

Simple and Amazing Crafts to  
Help Teach Children the Bible

*Gail Schoonmaker*





*Big Picture*  
**BIBLE  
CRAFTS**

**101** Simple and Amazing Crafts to  
Help Teach Children the Bible

*Gail Schoonmaker*



*Big Picture Bible Crafts: 101 Simple and Amazing Crafts to Help Teach Children the Bible*

Copyright © 2018 by Gail Schoonmaker

Published by Crossway

1300 Crescent Street  
Wheaton, Illinois 60187

All rights reserved. No part of this publication may be reproduced, stored in a retrieval system, or transmitted in any form by any means, electronic, mechanical, photocopy, recording, or otherwise, without the prior permission of the publisher, except as provided for by USA copyright law. Crossway® is a registered trademark in the United States of America.

Cover design and image: Kevin Lipp

First printing 2018

Printed in the United States of America

Scripture quotations are from the ESV® Bible (The Holy Bible, English Standard Version®), copyright © 2001 by Crossway, a publishing ministry of Good News Publishers. Used by permission. All rights reserved.

Trade paperback ISBN: 978-1-4335-5869-6

ePub ISBN: 978-1-4335-5872-6

PDF ISBN: 978-1-4335-5870-2

Mobipocket ISBN: 978-1-4335-5871-9

---

#### **Library of Congress Cataloging-in-Publication Data**

Names: Schoonmaker, Gail, author.

Title: The Big Picture Bible Crafts: 101 Simple and Amazing Crafts to Help Teach Children the Bible / Gail Schoonmaker.

Description: Wheaton: Crossway, 2018.

Identifiers: LCCN 2017024127 (print) | LCCN 2017054479 (ebook) |

ISBN 9781433558702 (pdf) | ISBN 9781433558719 (mobi) |

ISBN 9781433558726 (epub) | ISBN 9781433558696 (tp)

Subjects: LCSH: Bible crafts--Juvenile literature. | Christian education of children.

Classification: LCC BS613 (ebook) | LCC BS613 .S345 2018 (print) | DDC 220.95/05--dc23

LC record available at <https://lccn.loc.gov/2017024127>

---

Crossway is a publishing ministry of Good News Publishers.

VP 27 26 25 24 23 22 21 20 19 18  
15 14 13 12 11 10 9 8 7 6 5 4 3 2 1



## CONTENTS

Introduction . . . . .	5	51: God Protects Daniel from Lions. . . . .	118 ★★☆☆
1: God Creates the World . . . . .	6 ★☆☆☆	52: God Chooses Esther to Be Queen. . . . .	121 ★☆☆☆
2: Adam and Eve Reject God . . . . .	10 ★★☆☆	53: God Delivers His People . . . . .	122 ★★☆☆
3: God Talks to Cain and Abel . . . . .	11 ★☆☆☆	54: God Blesses Zechariah and Elizabeth . . . . .	124 ★☆☆☆
4: God Judges the World and Saves Noah . . . . .	13 ★★☆☆	55: God Reveals His Plan to Mary and Joseph . . . . .	126 ★★☆☆
5: God Confuses Languages at Babel. . . . .	17 ★★☆☆	56: God's Son Is Born. . . . .	128 ★★☆☆
6: God Counts Abraham Righteous. . . . .	20 ★☆☆☆	57: God Announces the Savior's Birth . . . . .	130 ★☆☆☆
7: God Blesses Abraham and Sarah . . . . .	22 ★★☆☆	58: God Is Glorified by Simeon and Anna . . . . .	132 ★☆☆☆
8: God Tests Abraham . . . . .	25 ★★☆☆	59: God Is Worshiped by Wise Men. . . . .	134 ★★☆☆
9: God Provides a Wife for Isaac . . . . .	27 ★★☆☆	60: Jesus Teaches Temple Leaders . . . . .	136 ★☆☆☆
10: Jacob Deceives Isaac. . . . .	29 ★★☆☆	61: Jesus Is Baptized . . . . .	139 ★☆☆☆
11: God Gives Jacob a Special Dream . . . . .	31 ★★☆☆	62: Jesus Resists Temptation . . . . .	141 ★☆☆☆
12: God Is with Joseph in Egypt . . . . .	34 ★★☆☆	63: Jesus Calls Twelve Disciples. . . . .	144 ★★☆☆
13: God Saves His People from Famine . . . . .	36 ★☆☆☆	64: Jesus Performs a Miracle at Cana . . . . .	147 ★☆☆☆
14: God Preserves Baby Moses . . . . .	38 ★★☆☆	65: Jesus Heals a Paralyzed Man . . . . .	150 ★★☆☆
15: God Calls Moses to Deliver His People. . . . .	40 ★★☆☆	66: Jesus Talks to Nicodemus. . . . .	153 ★☆☆☆
16: God Gives His People the Sign of Blood . . . . .	42 ★☆☆☆	67: Jesus Heals a Little Girl. . . . .	155 ★★☆☆
17: God Delivers His People from Slavery . . . . .	44 ★★☆☆	68: Jesus Is Anointed at Bethany. . . . .	158 ★★☆☆
18: The Israelites Praise and Thank God. . . . .	47 ★★☆☆	69: Jesus Meets a Samaritan Woman . . . . .	161 ★★☆☆
19: God Provides Food in the Wilderness . . . . .	49 ★★☆☆	70: Jesus Teaches the Parable of the Sower . . . . .	164 ★☆☆☆
20: God Gives Israel Victory over the Amalekites. . . . .	51 ★☆☆☆	71: Jesus Raises Lazarus from the Dead . . . . .	166 ★★☆☆
21: God Provides the Law (and the Israelites Reject Him). . . . .	53 ★★☆☆	72: Jesus Teaches the Parable of the Wise and Foolish Builders. . . . .	168 ★★☆☆
22: God Sends Spies to Canaan. . . . .	56 ★★☆☆	73: Jesus Praises a Poor Woman . . . . .	171 ★★☆☆
23: God Provides Water from a Rock . . . . .	58 ★☆☆☆	74: Jesus Calms a Storm . . . . .	173 ★★☆☆
24: God Makes a Donkey Speak. . . . .	59 ★★☆☆	75: Jesus Feeds a Large Crowd . . . . .	176 ★★☆☆
25: God Heals with a Bronze Snake. . . . .	62 ★☆☆☆	76: Jesus Reveals His Glory. . . . .	180 ★☆☆☆
26: God Protects Rahab's Family and Gives His People Victory over Jericho . . . . .	63 ★★☆☆	77: Jesus Tells the Story of the Good Samaritan . . . . .	182 ★☆☆☆
27: Achan Disobeys . . . . .	66 ★★☆☆	78: Jesus Blesses the Children . . . . .	184 ★☆☆☆
28: God Saves Israel through Gideon . . . . .	68 ★★☆☆	79: Jesus (and Peter) Walk on Water . . . . .	188 ★★☆☆
29: God Judges the Philistines through Samson . . . . .	70 ★★☆☆	80: Jesus Visits Mary and Martha. . . . .	191 ★☆☆☆
30: God Provides a Family for Ruth. . . . .	73 ★☆☆☆	81: Jesus Tells the Parable of the Prodigal Son. . . . .	194 ★☆☆☆
31: God Provides a Son for Hannah. . . . .	75 ★☆☆☆	82: Jesus Heals Ten Men with Leprosy . . . . .	196 ★☆☆☆
32: God Calls Samuel . . . . .	77 ★★☆☆	83: Jesus Visits Zacchaeus . . . . .	198 ★★☆☆
33: God Is Greater Than a Fake God . . . . .	79 ★★☆☆	84: Jesus Is Worshiped as He Enters Jerusalem. . . . .	202 ★★☆☆
34: God Chooses Saul to Be King . . . . .	82 ★☆☆☆	85: Jesus Clears the Temple . . . . .	205 ★★☆☆
35: God Chooses David to Be King . . . . .	83 ★★☆☆	86: Jesus Establishes the Lord's Supper. . . . .	208 ★★☆☆
36: God Delivers Israel from the Philistines . . . . .	85 ★☆☆☆	87: Peter Denies Jesus . . . . .	211 ★★☆☆
37: God Provides a Friend for David. . . . .	88 ★★☆☆	88: Jesus Is Crucified . . . . .	214 ★★☆☆
38: God Chooses Solomon to Build the Temple . . . . .	90 ★★☆☆	89: Jesus Is Alive! . . . . .	218 ★★☆☆
39: God Withholds Dew and Rain . . . . .	93 ★★☆☆	90: Jesus Returns to Heaven and Sends His Spirit. . . . .	219 ★★☆☆
40: God Displays His Power over Baal . . . . .	95 ★★☆☆	91: God Heals a Man through Peter and John. . . . .	221 ★★☆☆
41: God Takes Elijah to Heaven . . . . .	98 ★★☆☆	92: Stephen Stands Firm . . . . .	224 ★★☆☆
42: God Performs Miracles through Elisha. . . . .	100 ★★☆☆	93: God Uses Philip to Teach a Man from Ethiopia. . . . .	228 ★★☆☆
43: God Teaches Job and His Friends. . . . .	102 ★★☆☆	94: God Gives Peter a Vision. . . . .	230 ★★☆☆
44: God Has Mercy on Nineveh . . . . .	104 ★★☆☆	95: Lydia Follows Jesus . . . . .	233 ★★☆☆
45: God's Word Is Found. . . . .	106 ★☆☆☆	96: God Frees Paul and Silas and Saves a Jailer. . . . .	236 ★★☆☆
46: God Makes Dry Bones Live. . . . .	108 ★☆☆☆	97: The Whole Armor of God . . . . .	238 ★★☆☆
47: God Is with His People in Exile . . . . .	110 ★★☆☆	98: The Fruit of the Spirit . . . . .	241 ★☆☆☆
48: God Delivers Shadrach, Meshach, and Abednego . . . . .	112 ★★☆☆	99: God Delivers Paul from Enemies in Damascus. . . . .	244 ★★☆☆
49: God Humbles Nebuchadnezzar. . . . .	114 ★★☆☆	100: God Delivers Paul from a Shipwreck . . . . .	246 ★★☆☆
50: God Writes on the Wall. . . . .	116 ★★☆☆	101: God Gives John a Vision of Things to Come. . . . .	248 ★★☆☆
		Photo Credits and Permissions. . . . .	252



*For all of my students  
who have taught me so much,*

*And for Sarah  
who inspires and delights me*

*And for Keith  
who encourages and loves me*



# INTRODUCTION

There are few things I love more than watching my children or students on the edges of their seats, listening to Bible stories with wide-eyed excitement. God's Word is powerful and active for an audience of any age! Creating a craft that depicts a scene, character, or object from a Bible passage reinforces that story by prompting kids to retain and retell it as they show off their craft.

## MAKE IT SIMPLE

Each craft has a “Make It Simple” section that is written especially for teachers of preschoolers. It contains instructions, based on my own teaching experience, on what steps you need to complete before class in order to ensure that projects can be finished during craft time. It leaves the coloring, drawing, some folding, and pasting to the students, but requires you to gather materials—copying, folding, and cutting as needed ahead of time.

For some crafts, depending on your class size, this can be a good bit of work. Copy early in the week and keep your bag of images to be cut out, together with several pairs of adult scissors, ready to go during moments of down time (while watching a show or a sports event or waiting for carpool kids to show up). Better yet, pass out scissors and materials to your friends at a mid-week Bible study or youth group and watch them complete the cutting in a fraction of the time it would take you alone. The work is all worth it when you see your students adore their crafts.

I highly recommend you complete one sample ahead of time so your students can see where their work is headed. Also, be sure to show individual interest and make positive comments as students' work progresses.

## MAKE IT AMAZING

The “Make It Amazing” sections are for the “big kids.” They can already read and complete all the directions to make the basic crafts themselves. This section has ideas for adding detail to their crafts with special materials, personal drawing skills, and creative imaginations. Materials for these ideas are not listed in the supply sections for the basic versions of the crafts, so plan ahead to get everything they might need, including copies.

Read the Bible passage(s) listed so the kids have some context for the craft, then let them use their skills to make the craft fully theirs.

## STAR COMPLEXITY SCALE

Each craft bears a number of stars to indicate its level of complexity. The basic instructions for one-star crafts ★☆☆ require little preparation and are easy to complete, three-star crafts ★★★ require the greatest skill and time commitment. If you want to make three-star crafts but have limited time, check out “Make It Simple” for ways to simplify them significantly.

## MATERIALS

It is well worth the cost to purchase a package of cardstock, because the extra thickness and weight of the paper will help the crafts hold their shapes, especially while being colored and glued. The three-dimensional crafts will be less likely to collapse or be crushed, and all of them will last longer than those made from regular paper. White cardstock is great for almost every craft in this book, and dozens of additional colors are available for purchase when you want them.

### *Glue Tips*

I generally let my preschoolers do their own pasting, so they each get a glue stick. But when paste isn't strong enough and liquid glue is necessary, I carry around the bottle and ask the children to show me where they want their, say googly eyes, and I put a dot of glue there myself. I have learned the hard way that handing a bottle of glue to a little one can lead to disaster.

Hot glue is fantastic when you want a strong hold that dries immediately, and it can fasten heavy materials that would fall apart with regular glue. Teachers of young students might need to complete hot gluing before class for safety reasons, and big kids should have adult help (or at least permission) to use a glue gun. If you need to use regular glue instead, the craft instructions indicate when you will need to let it dry overnight before continuing with the next steps.

Sometimes, if there is an especially messy element, I send two students at a time to a different table where my co-teacher helps them complete the messy part, then they return to the main table and two other students go over.



## GOD CREATES THE WORLD

### Genesis 1-2

In the beginning, God created the heavens and the earth.  
(Gen. 1:1)

God saw everything that he had made, and behold, it was very good. (Gen. 1:31)

### SUPPLIES:

(to make one craft)

- 2 sheets of white copy paper
- templates of creation (see pages 8-9)
- optional:* glue
- scissors
- crayons *or* markers
- optional:* silver metallic paint pen
- optional:* 1 cotton ball
- optional:* foil star stickers
- optional:* fish-shaped crackers

### INSTRUCTIONS:

Unlike most crafts in this book (which should be assembled after the corresponding story is read), class time limits may dictate that this craft be colored as the creation story is taught.

**PREP STEP:** Copy the creation templates onto copy paper.

1. Cut the pictures out. Fold them in half so that **1** and **6** are visible on one semicircle, and **3** and **4** are visible on the other semicircle. If you wish, make this fold permanent by pasting the halves of each circle together. (The back of **6** should be pasted to the back of **7**, and the back of **2** should be pasted to the back of **3**.)



Step 1

2. Now fold each semicircle in half again, bringing the left half over the right as if closing a book, so the Bible verses are on the cover of one little book, and **2** is on the cover of the other. Slide the **2** book inside the "verses" book to make one eight-page book that progresses sequentially through the seven days of the creation story.

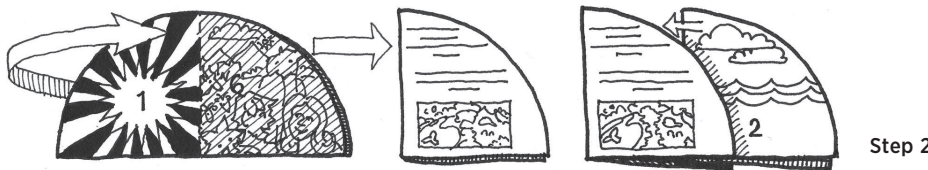

Step 2

3. *Optional* additions include lining the “light” in day one with metallic paint marker, gluing a bit of thinned cotton ball to the cloud(s) in day two, adding star sticker(s) to day four, and gluing fish-shaped cracker(s) to day five.
4. If you temporarily turn the 2 book inside out so that 4 is on its cover, and slide it back inside the other book, the parallels are illustrated between days one and four (light and heavenly bodies), days two and five (water/sky and fish/birds), and days three and six (land and animals/people). The symmetry of God’s work “forming” and “filling” in the creation account can then be seen.

**MAKE IT SIMPLE:** Cut out and crease the circles before class.

**MAKE IT AMAZING:** Make a similar book about creation from two circles, but make every page entirely your own artwork. Find special colored papers to be the sky, water, and land. Cut shapes and images from foil, magazines, packaging, or photographs. Draw with markers, metallic pens, glitter glue, or puff paint. Let everything dry completely before folding and assembling the book. Don’t forget to number the days! It is fine if the pages don’t close flat because of items that were glued in: let it stand up in a double semicircle.

7



In the beginning,  
God created the  
heavens and the earth.  
**GENESIS 1:1 ESV**

God saw everything that he  
had made, and behold,  
it was very good.  
**GENESIS 1:31 ESV**

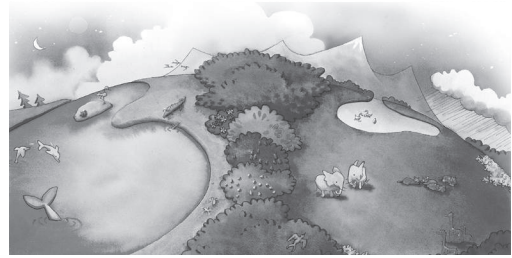

9

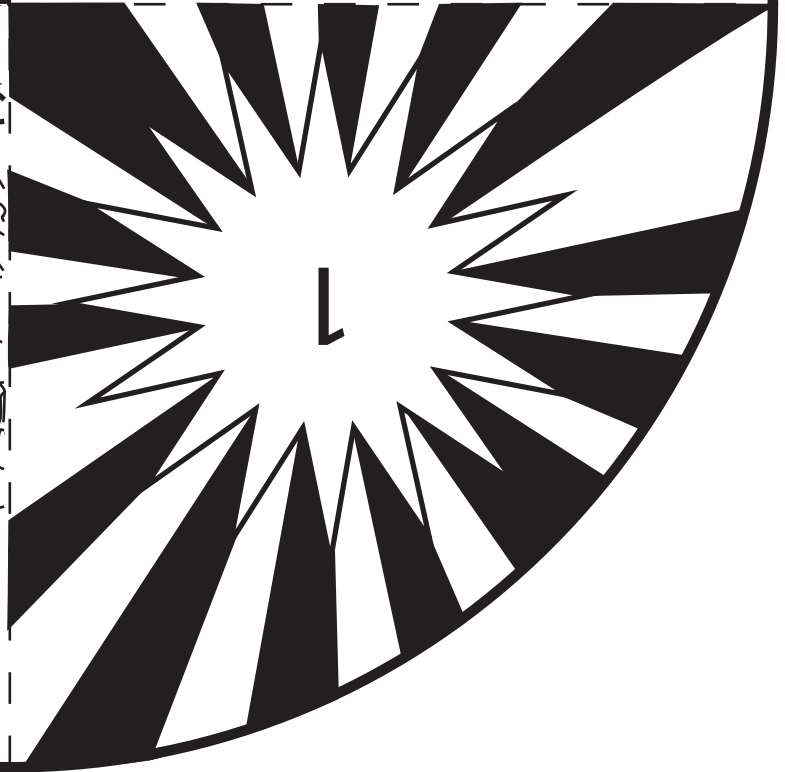

creation template



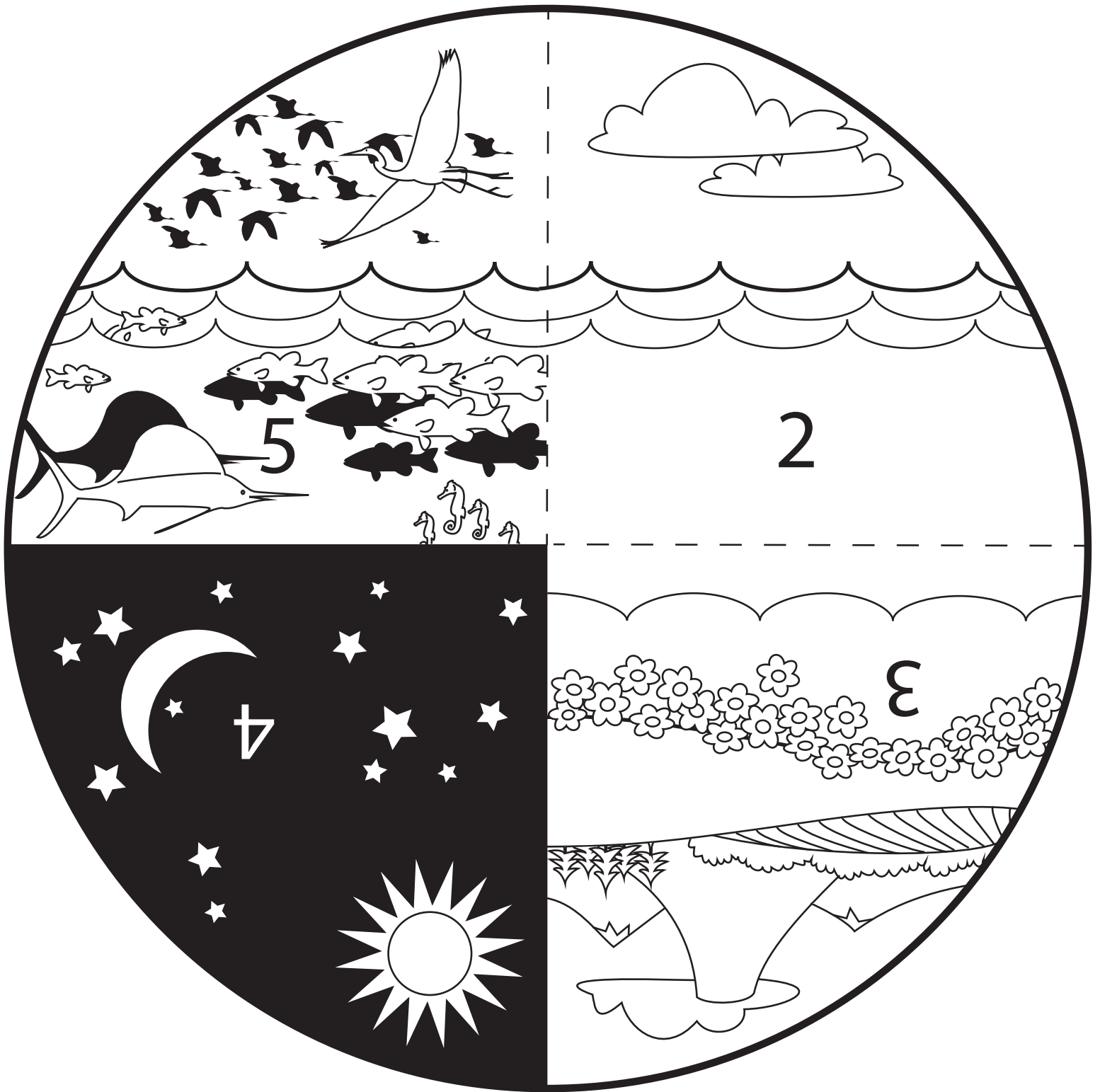

creation template

## ADAM AND EVE REJECT GOD

### Genesis 3

All have sinned and fall short of the glory of God.  
(Rom. 3:23)

#### SUPPLIES:

(to make one craft)

- 1 red paper plate (not plastic), any size (generally found with party supplies)
- 1 piece of green paper or a leaf snipped from an artificial plant
- 1 twig or tightly rolled strip of brown paper
- scissors
- glue, tape, and/or stapler
- 1 black crayon
- optional: 1 large googly eye
- optional: 1 sheet of copy paper

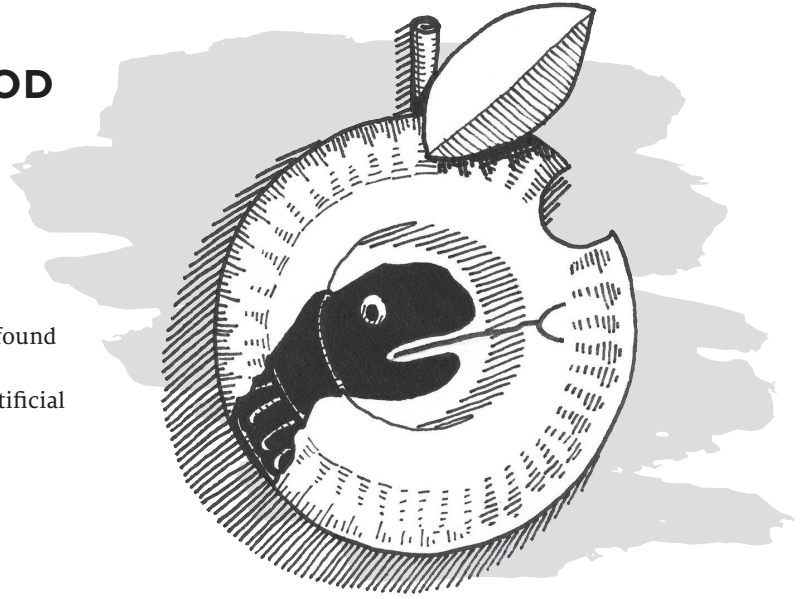

#### INSTRUCTIONS:

**PREP STEP:** Optional for **Step 4:** Copy the illustrated verse below.

1. Give your red-plate “apple” a leaf and stem: Cut a leaf shape from green paper and crease it lengthwise, or snip a leaf from an artificial plant. Trim a twig or length of tightly rolled brown paper to desired shape and height. Then glue, tape, or staple the leaf and twig to the top of your apple.
2. Hold a black crayon in one hand and place the side of your other hand, pinkie side down, on the apple. Loosely curl your four fingers in toward your palm like a snake’s head, and lower your thumb until it looks like a snake’s lower jaw with its mouth open. Use the crayon to trace around the outside of your hand and forearm, creating the outline of a snake. Color the snake black and add a forked tongue if you wish. Glue on a googly eye (or draw an eye before you color the snake).

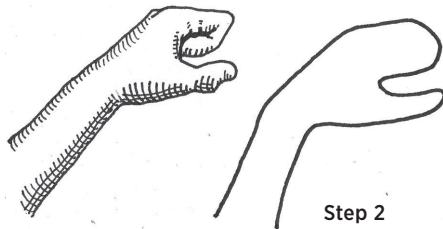

3. Cut out a bite shape from a side of the apple.
4. *Optional:* Cut out the illustrated verse and paste it to your apple.

**MAKE IT SIMPLE:** Scissors skills will vary widely among small children, so have a stack of paper leaves ready for students who don’t wish to cut their own or who become dissatisfied with their attempts. Prepare stems ahead of time, whether real or paper.

**MAKE IT AMAZING:** Trace your hand and forearm onto the back of sparkly or other fancy black paper, then cut out the snake shape and glue it to your apple. To more easily see your tracing on the black paper, try using a light-colored colored pencil, crayon, pastel, chalk, or even piece of soap.

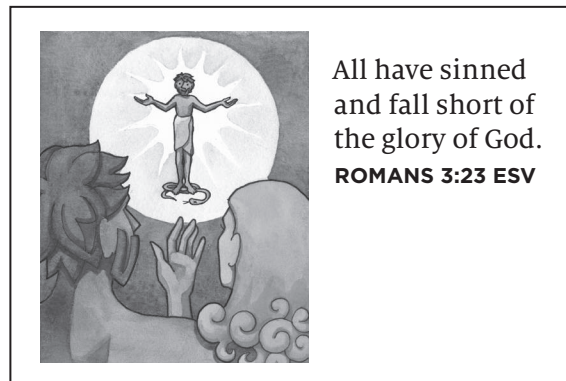

All have sinned  
and fall short of  
the glory of God.  
**ROMANS 3:23 ESV**

## GOD TALKS TO CAIN AND ABEL

*Genesis 4:1-16*

Let us offer to God acceptable worship, with reverence and awe. (Heb. 12:28)

### SUPPLIES:

(to make one craft)

- 2 sheets of white or tan cardstock
- templates of brothers with offerings (the full page) and Cain's face (see pages 11–12)
- crayons or markers
- scissors
- optional*: craft knife such as X-Acto™
- 1 brass fastener
- optional*: 1 sheet of copy paper

### INSTRUCTIONS:

**PREP STEP:** Copy the face template and the full-page brothers template onto white or tan cardstock.

1. Color the brothers. Then color Cain's face and cut it out.
2. Push the points of a brass fastener through the ⊗ in Cain's face, then through the ⊗ in the picture of the brothers. If Cain is printed on cardstock, the inside of the circle may need to be slit with a craft knife (with adult assistance) before the fastener will go through. Spread the arms of the fastener on the back of the paper. Begin with Cain happy, then swivel 180 degrees to make his face "fall" when God has no regard for his offering.
3. *Optional*: Cut out the illustrated verse and glue it to the craft.

**MAKE IT SIMPLE:** Cut out the Cain heads before class and, if necessary, score the circles where the fasteners will pass through.

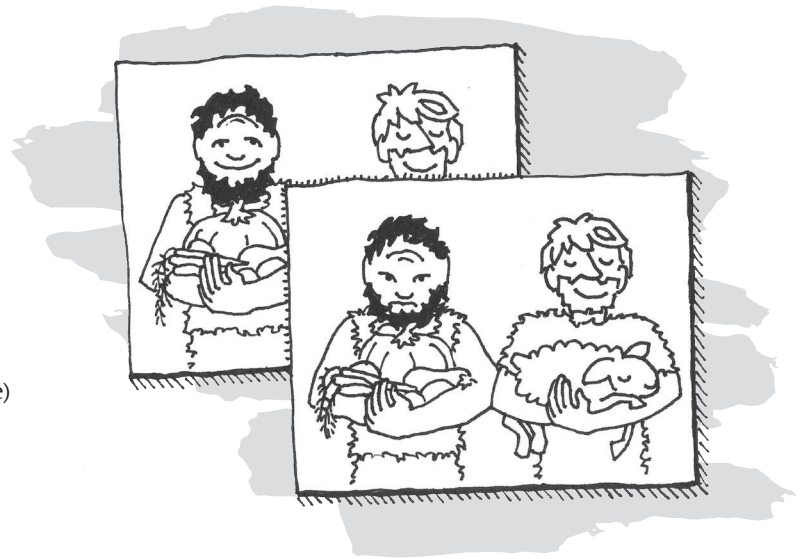

Cain's face template

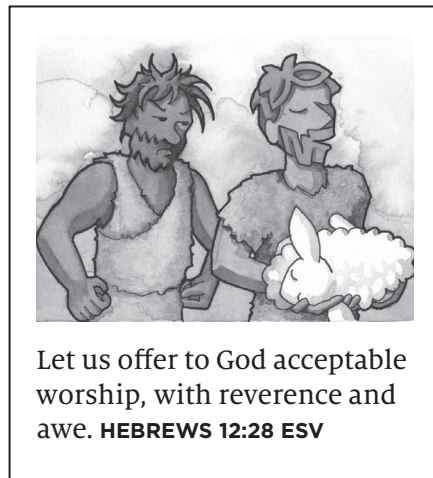

Let us offer to God acceptable worship, with reverence and awe. **HEBREWS 12:28 ESV**



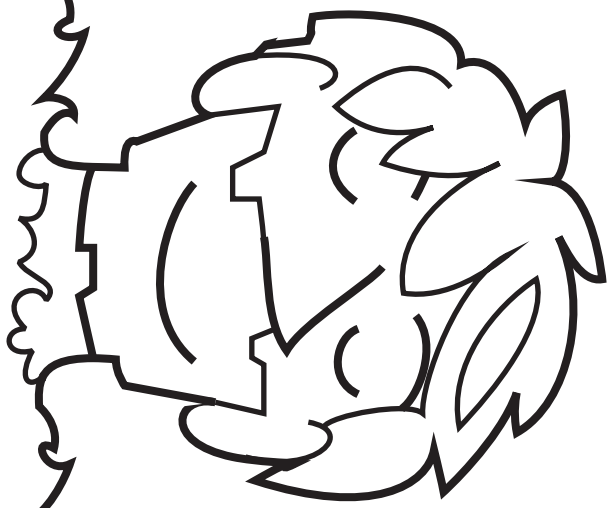
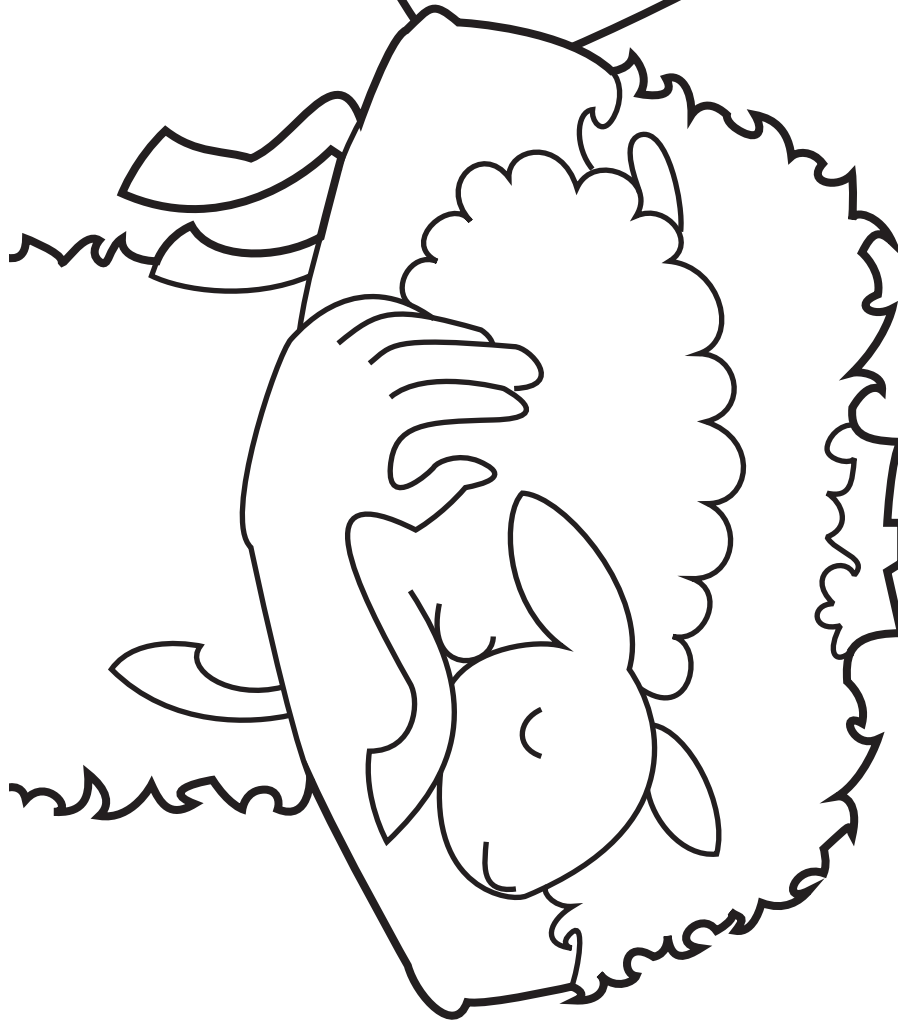
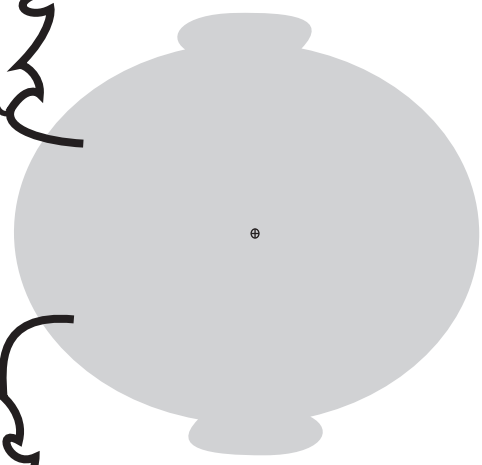
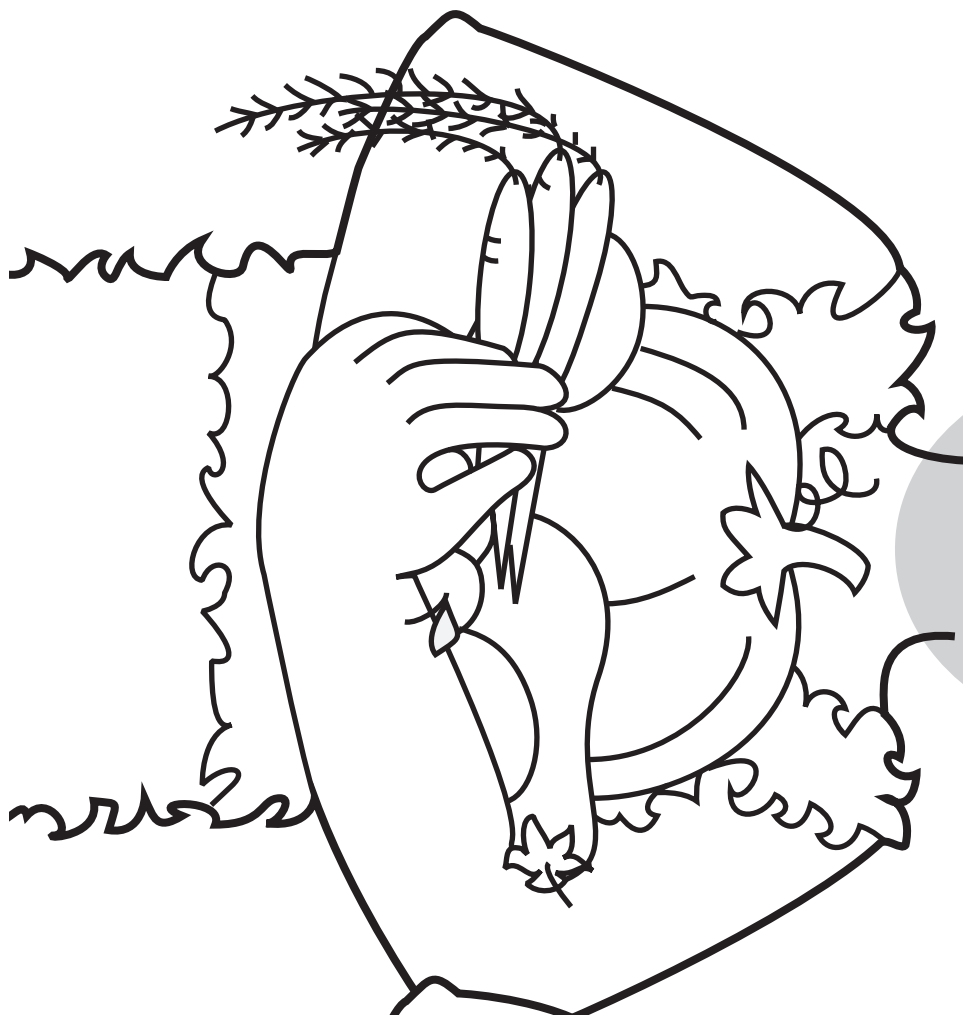

## GOD JUDGES THE WORLD AND SAVES NOAH

*Genesis 6:1–9:17*

Noah . . . became an heir of the righteousness that comes by faith. (Heb. 11:7)

### SUPPLIES:

(to make one craft)

- 1–2 sheets of white cardstock
- template of ark and *optional* template of corrupt earth (see pages 15–16)
- 1 sheet of dark-blue colored paper
- optional*: 1 sheet of light-blue copy paper, cardstock, or construction paper
- optional*: 1 sheet of copy paper
- crayons or markers
- scissors
- glue
- tape
- craft knife such as X-Acto™

### INSTRUCTIONS:

While often presented as a happy tale of animals together on a boat, the story of Noah's ark is actually a sober account of God's judgment on wickedness. Should you wish to include the element of judgment in your craft, begin at **Step 1a**. If this element is not desirable or appropriate for your students, begin at **Step 1b**.

**PREP STEP:** Copy the ark template onto white cardstock. *Optional for Step 1a:* Copy the corrupt earth template onto white cardstock. *Optional for Steps 4 and 5:* Copy additional animals to be cut out and pasted into the ark—feel free to copy two of each! *Optional for Step 6:* Copy the illustrated verse.

1. a. (With judgment theme) Begin by coloring a copy of the corrupt earth page.  
b. (With no judgment theme) Begin with a light-blue or gray-colored paper in the “landscape” position.
2. Make a rectangle of dark blue paper that is 6-inches high and the same width as your backing sheet, and cut shallow wave shapes along one long edge. Glue or tape down only the left edge of the water piece to either the corrupt earth page or the light-blue or gray paper so that the “water” can be lifted to reveal the page below it.

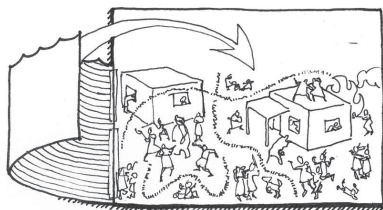

Step 2

3. If you want to use the ark with animals and people already printed inside, color the animals and people within. Cut the image out and use a craft knife or scissors to cut along the three solid-lined edges of each window. Fold on the horizontal dotted line, bringing the window half of the ark down over the animal half. Lift the window flaps to reveal the animals inside and crease on the dotted lines. Color what is now the front of the ark.

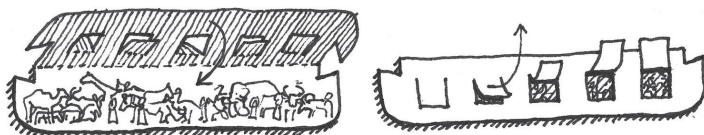

Step 3

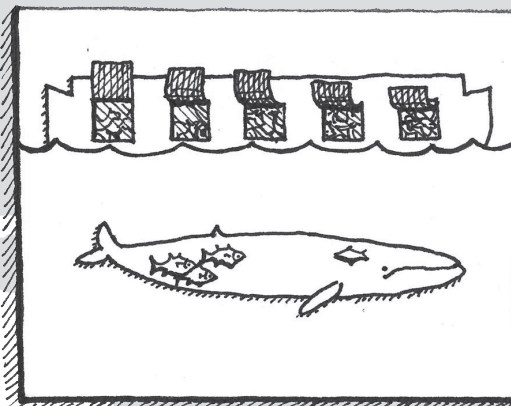

4. If you want to use an empty ark and put your own animals inside, cut out the ark and partial windows as described in Step 3 (from brown paper, if you wish), then turn it “inside out” so that the side with the printed animals is face down. Use animal stickers or cut out the animals you like best from the templates provided, color them, and paste them into the ark. Fold and color the ark.



Step 4

5. Place the ark on the backing sheet so that the “waves” cover its bottom edge but do not reach the windows. Glue it in place. If you wish, color and cut out the whale and/or fish images and paste them on or under the water.
6. *Optional:* Cut out the illustrated verse and paste it to your picture.

**MAKE IT SIMPLE:** Use the pre-printed animal side; cut and crease everything before class.

**MAKE IT AMAZING:** Draw additional animals in the ark and in the water.

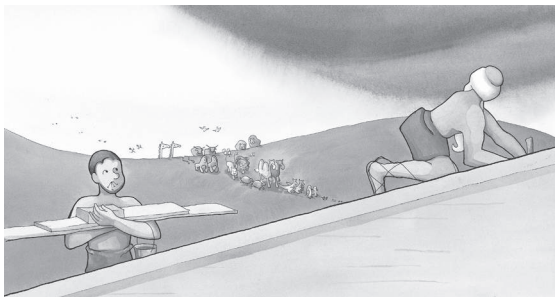

Noah . . . became an heir of the righteousness that comes by faith. **HEBREWS 11:7 ESV**



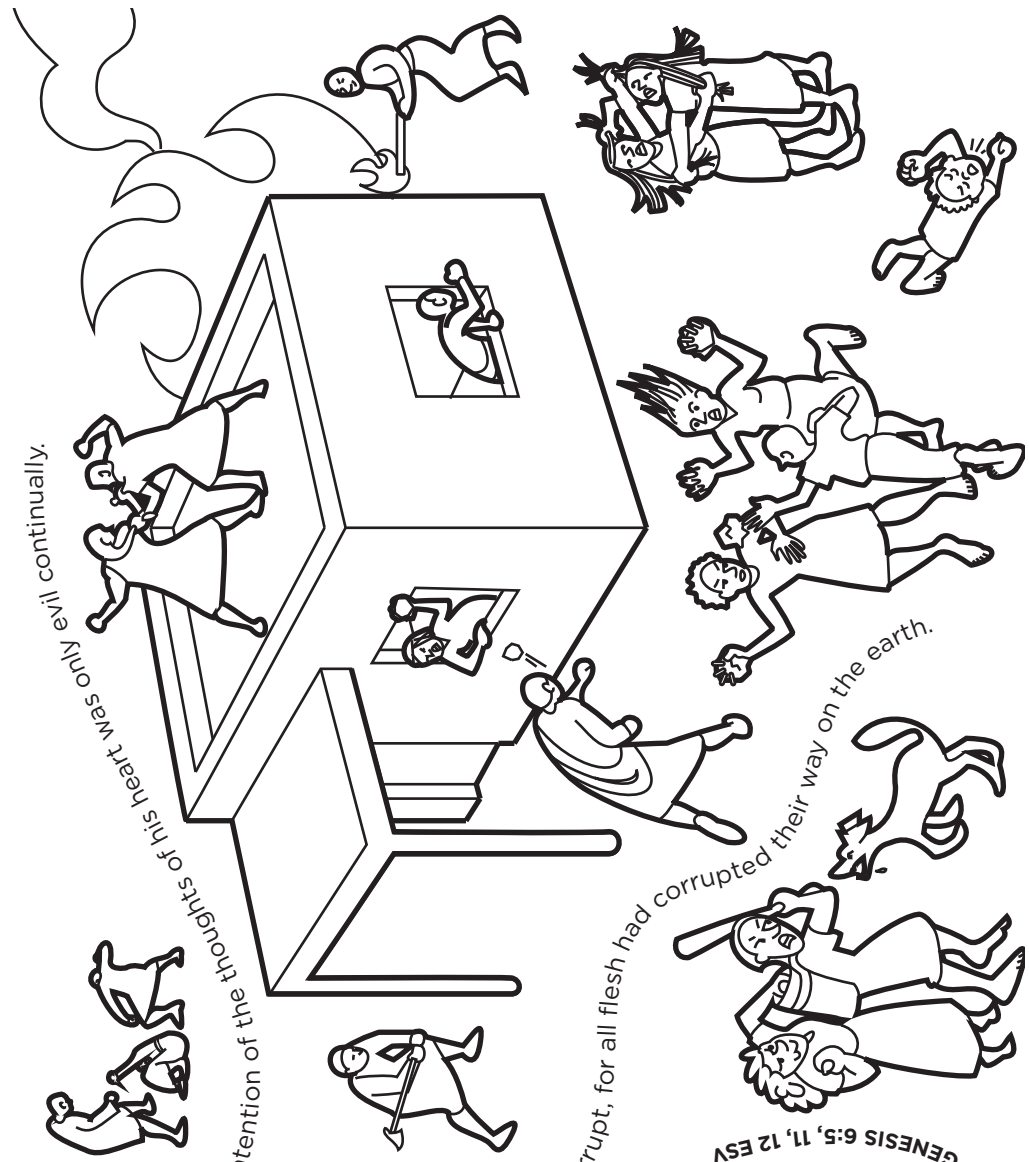

God saw the

earth, and behold, it was corrupt,

for all flesh had corrupted their way on the earth.

GENESIS 6:5, 11, 12 ESV

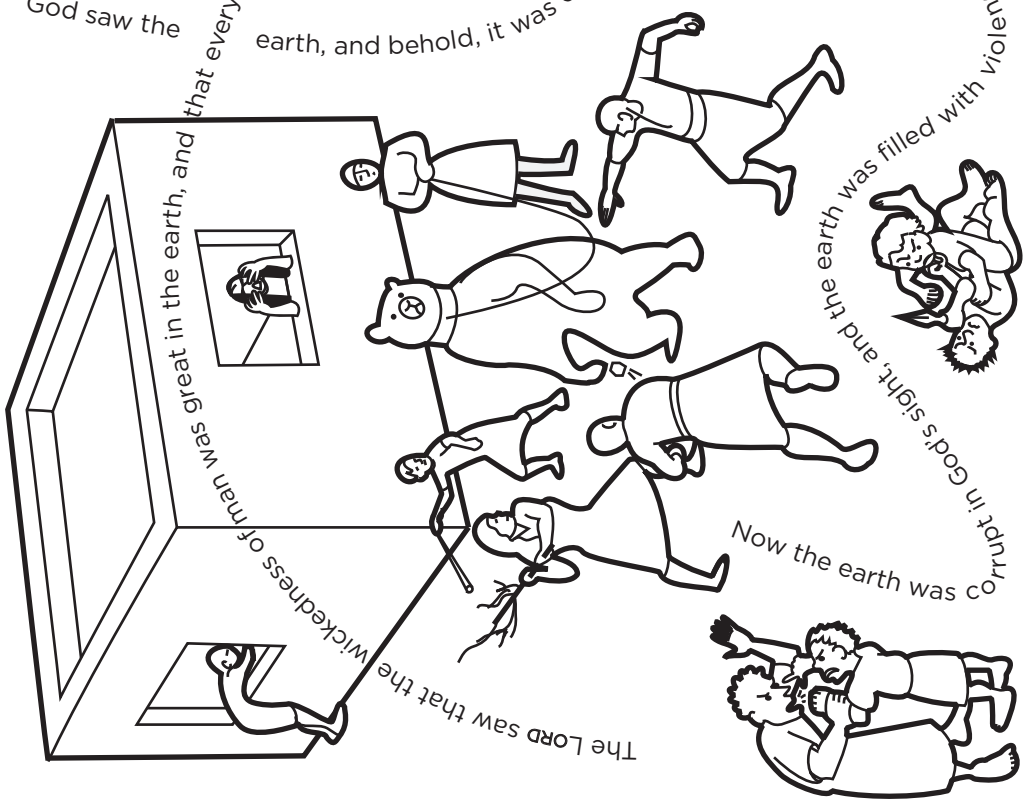

The Lord saw that the wickedness of man was great in the earth, and that every intention of the thoughts of his heart was only evil continually.

Now the earth was corrupt in God's sight, and the earth was filled with violence.

GENESIS 6:5, 11, 12 ESV

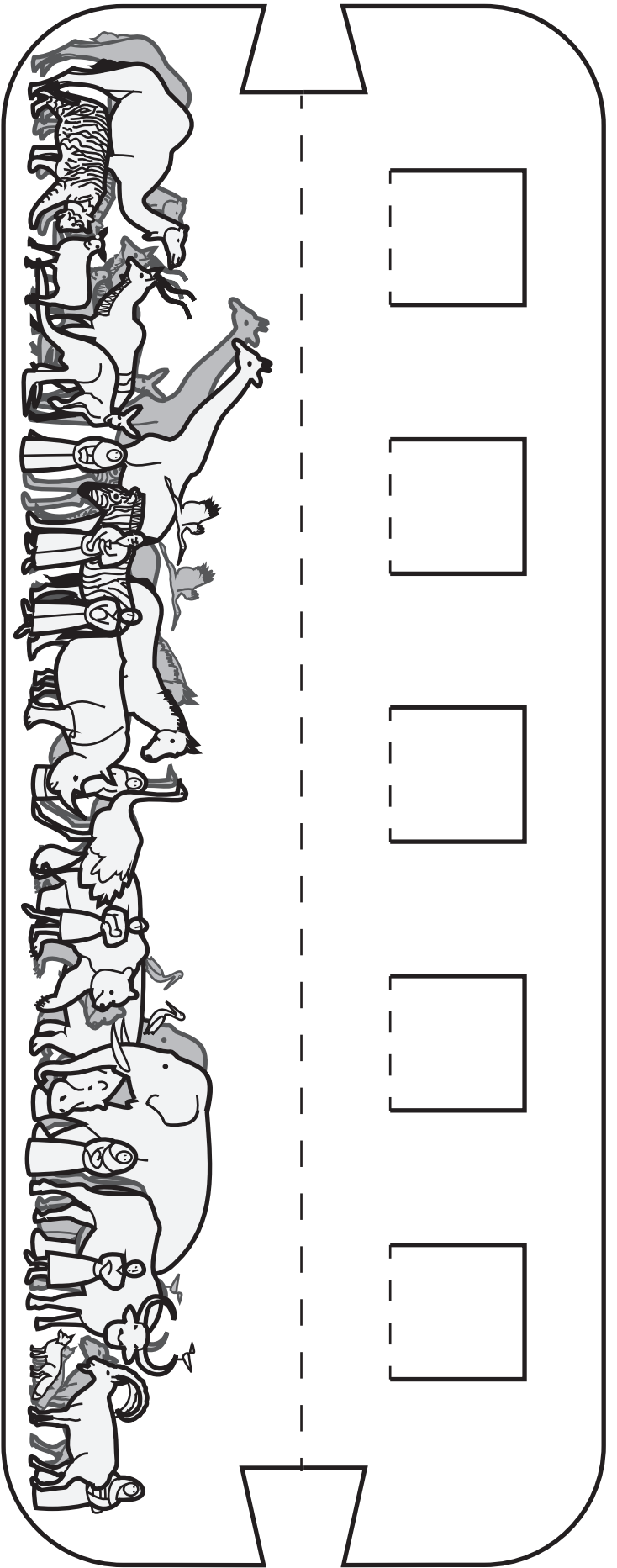

ark template

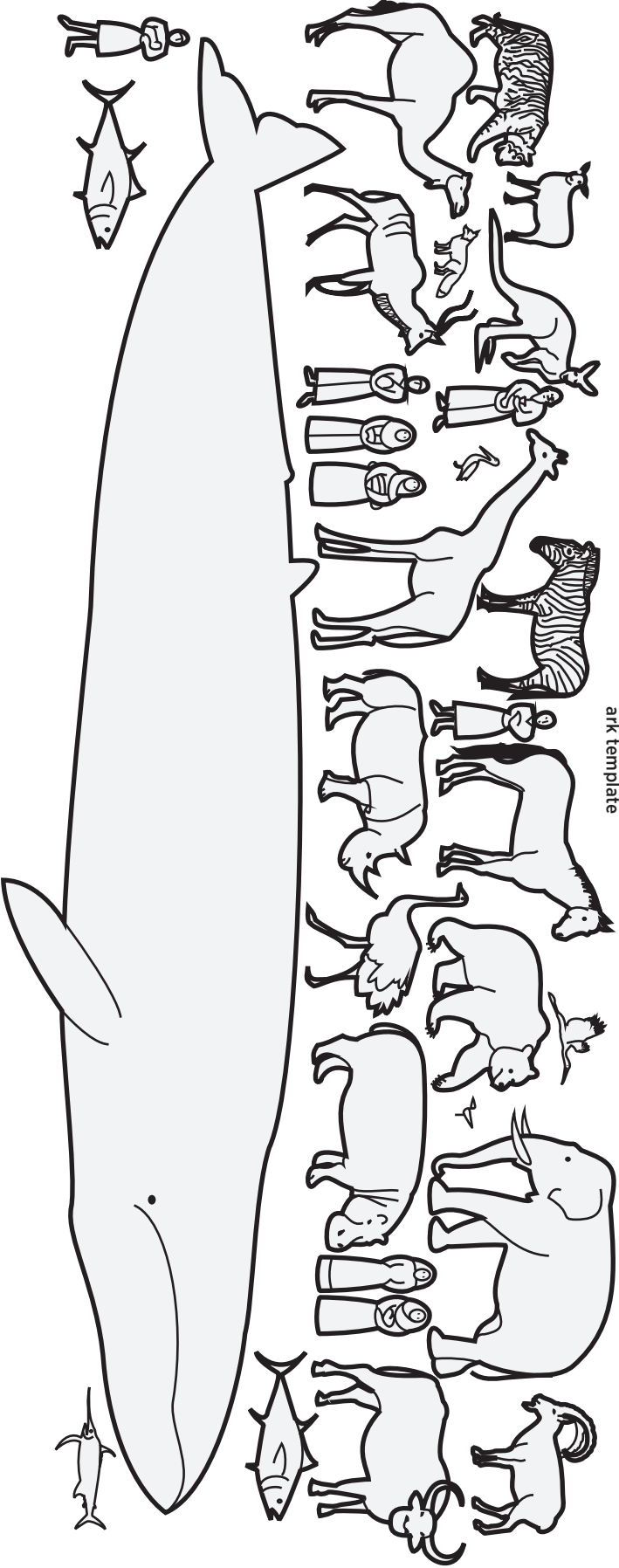

additional animal templates

## GOD CONFUSES LANGUAGES AT BABEL

*Genesis 11:1-9*

Unless the LORD builds the house, those who build it labor in vain. (Ps. 127:1)

### SUPPLIES:

(to make one craft)

- 5 sheets of white cardstock
- template of tower (see page 19)
- crayons or markers
- scissors
- glue
- tape
- optional*: 1 sheet of copy paper

### INSTRUCTIONS:

**PREP STEP:** Copy the tower template onto cardstock twice, then reduce the copy size to 90 percent and copy it again. Place that reduction on the platen and copy it at 90 percent. Place that last reduction on the platen and copy it at 90 percent. You now have five copies in four different sizes. *Optional for Step 5:* Copy the illustrated verse.

1. Color your five tower pieces.
2. Cut out the five tower pieces along the bold lines of their outer rectangle shapes. Fold the top and bottom sections of each rectangle back along the horizontal dotted lines and crease well. Cut along the solid lines from the paper edges to the folds, creating eight long flaps above and eight short flaps below the image on each piece.

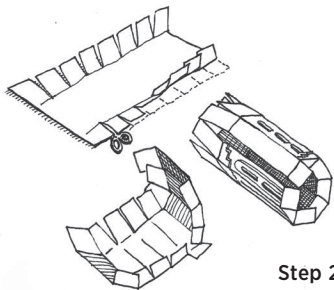

Step 2

3. Fold the image back along each of the seven vertical dotted lines. Take one of the two largest tower pieces and use tape to join the outer vertical edges, creating an eight-sided cylinder. For the remaining four tower pieces, paste the last vertical section of the image over the first vertical section to create seven-sided cylinders. The flaps at the tops and bottoms of each cylinder should be overlapped to create "ceilings" and partial "floors." Use paste and tape to secure the flat ceilings of each cylinder-tower piece. Do not fasten the floor flaps together until you have decided how to store your tower.

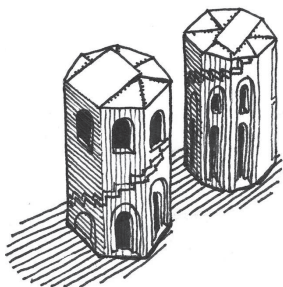

Step 3

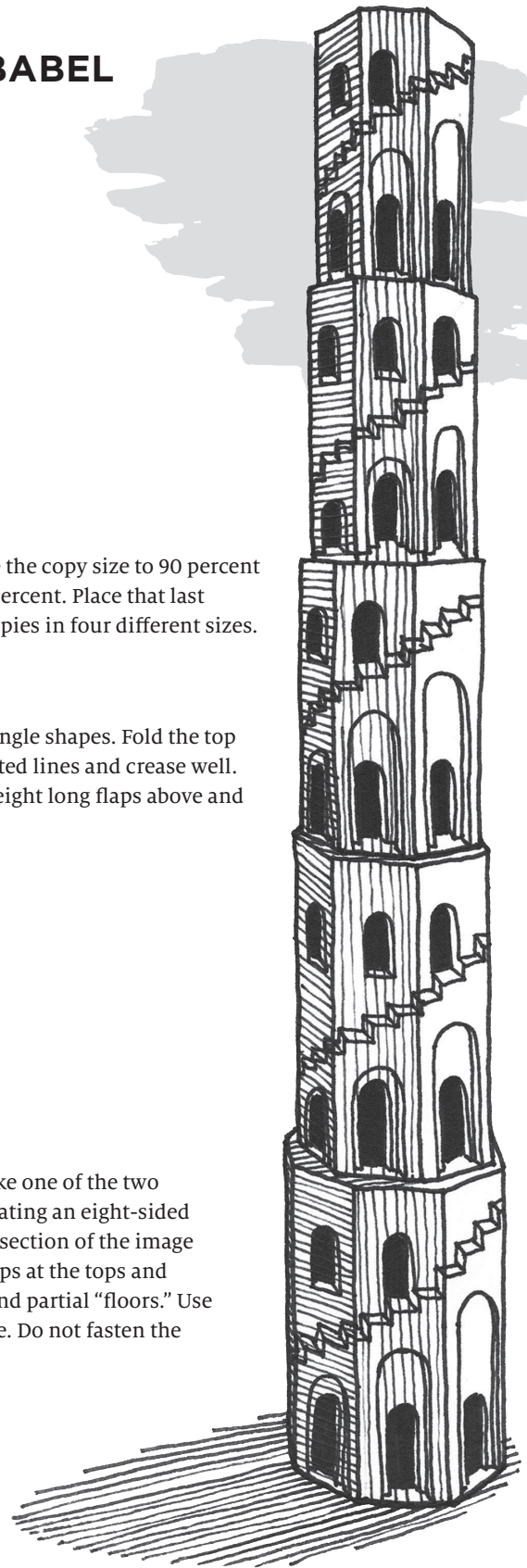



4. Stack and center the tower pieces from largest at the bottom to smallest at the top. If you want to secure your tower in this formation, glue the floor of each tower piece to the ceiling of the tower piece below it. If, instead, you want to store your tower pieces in a smaller space and stack them again later, they can all be nested inside one another, provided the floor flaps are free to fold all the way back.

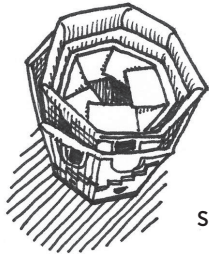

Step 4

5. *Optional:* Cut out the illustrated verse and paste it to your tower.

**MAKE IT SIMPLE:** Even if you do all the cutting and folding ahead of time, this craft is tricky and time-consuming. As an alternative, have little ones make a two-dimensional tower: Copy the template in descending sizes as above, but eliminate one of the full-sized copies. Cut off all the flaps and the unprinted vertical section of each image and fold nothing. Then, with the children, lay out the four tower pieces, centered atop one another in ascending-size order as pictured, color them, and tape them together on the back side.

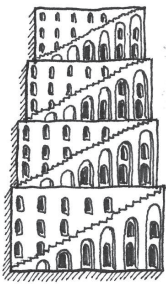

Make It Simple

**MAKE IT AMAZING:** Make an even taller tower by continuing to reduce and copy the template. Or enlarge the template in sections and join the sections to make larger tower pieces.

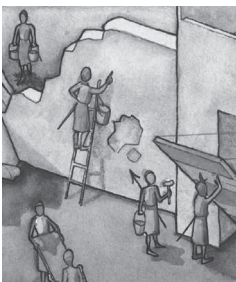

Unless the LORD builds  
the house, those who  
build it labor in vain.

**PSALM 127:1 ESV**

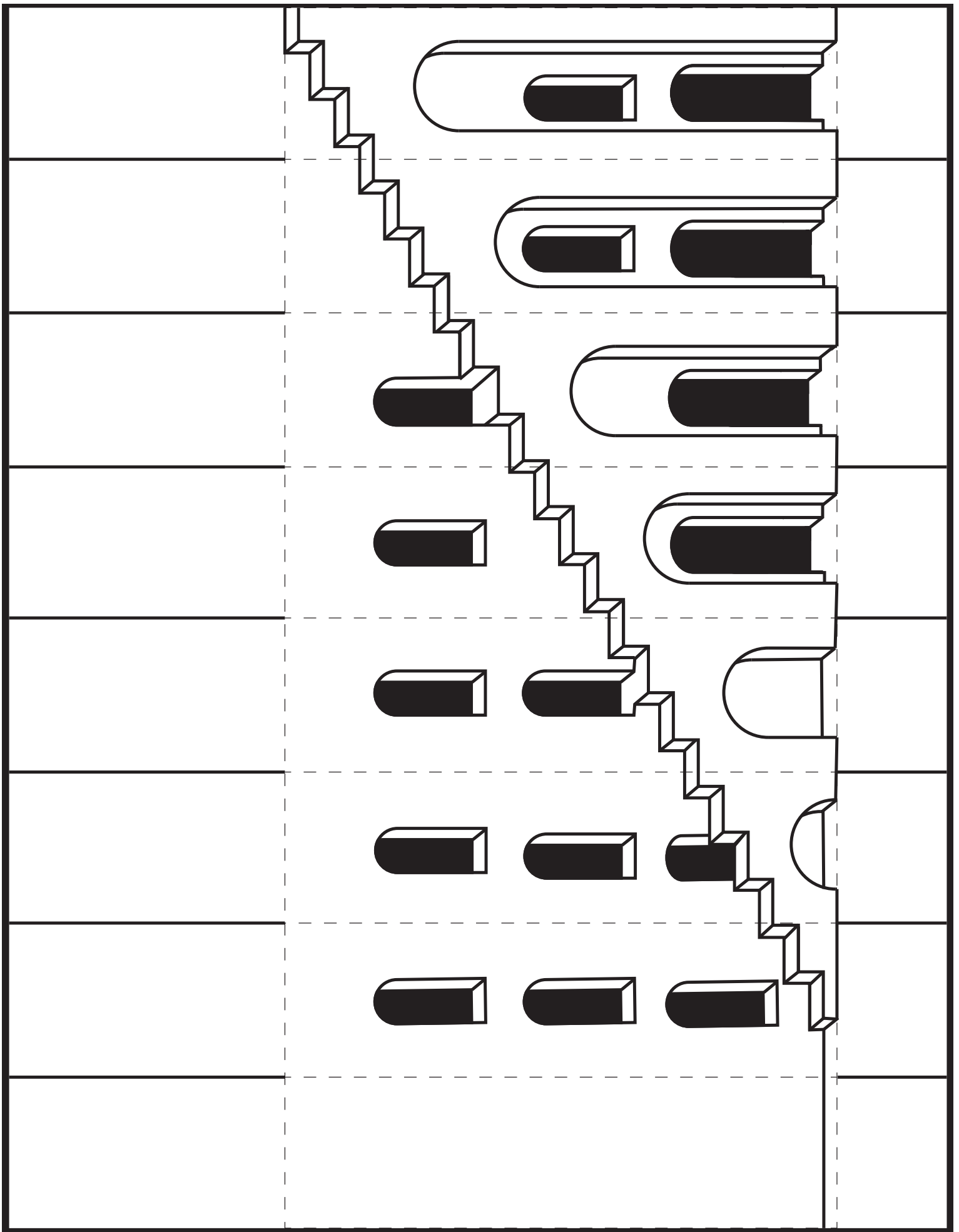

## GOD COUNTS ABRAHAM RIGHTEOUS

*Genesis 15:1-6*

[Abraham] believed the LORD, and he counted it to him as righteousness. (Gen. 15:6)

### SUPPLIES:

(to make one craft)

- 1 sheet of white cardstock
- template of Abraham (see page 21)
- scissors
- crayons or markers
- foil star stickers
- optional:* white and/or yellow crayons or oil pastels
- optional:* copy paper

### INSTRUCTIONS:

**PREP STEP:** Copy the Abraham template onto white cardstock. *Optional for Step 3:* Copy the illustrated verse below.

1. Cut off any white showing at the paper edges of the picture so that the entire paper is black with the exception of Abraham himself. Color Abraham.
2. Fill the night sky with star stickers. *Optional:* Use crayons or oil pastels to draw additional stars of various sizes.
3. *Optional:* Cut out the illustrated verse and paste it to the back of your picture.

**MAKE IT SIMPLE:** Trim pictures before class. Then make it easier for little ones to remove star stickers from their backing sheet either by folding the backing in such a way that the tips of the stars pop up or by removing all of the sticker area around the stars themselves.

**MAKE IT AMAZING:** Use glitter glue to create additional stars. Dry flat overnight.

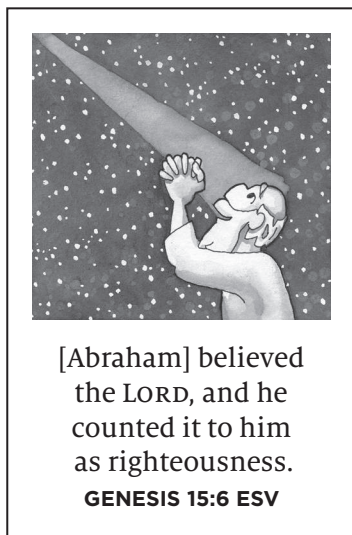



## GOD BLESSES ABRAHAM AND SARAH

*Genesis 17:15–18:15; 21:1–7*

The LORD visited Sarah as he had said, and the LORD did to Sarah as he had promised. (Gen. 21:1)

### SUPPLIES:

(to make one craft)

- 2 matching sheets of colored paper
- templates of tent, Abraham with Sarah, and baby Isaac (see pages 23–24)
- 2 sheets of white copy paper
- scissors
- glue
- crayons or markers
- craft knife such as X-Acto™



### INSTRUCTIONS:

**PREP STEP:** Copy the templates of the tent, Abraham with Sarah, and baby Isaac onto white copy paper.

1. Place the tent picture on top of two matching sheets of colored paper. Cut out the tent silhouette through all the papers at once, then glue the two colored tent shapes together, running the glue along the top and side edges only. Cut a vertical door slit up the center of only the top tent, stopping 1 ½ inches from the peak. Fold the triangular tent flaps up to open the doors.

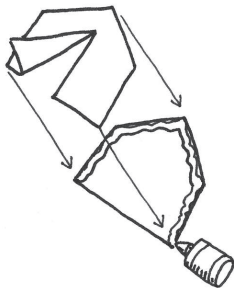

Step 1

2. Color and cut out Abraham and Sarah, then use a craft knife (with adult assistance) to cut a slit along the bold line above the couple's hands and forearms. Glue the couple into the tent so that they are visible when the doors are open, but avoid gluing the area around the slit.
3. Color and cut out baby Isaac, then nestle him into his parents' arms with or without a spot of glue.
4. *Optional:* Cut out the illustrated verse and glue it to the tent.

**MAKE IT SIMPLE:** Cut out the tent and figures ahead of time, including the slit above the hands. Glue the tent halves together and crease the tent flaps.





Abraham and Sarah template

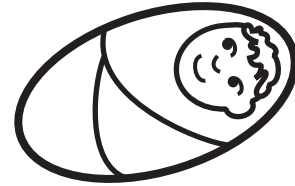

baby Isaac template

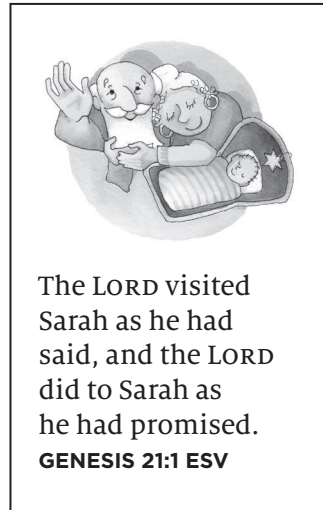

The LORD visited Sarah as he had said, and the LORD did to Sarah as he had promised.  
**GENESIS 21:1 ESV**

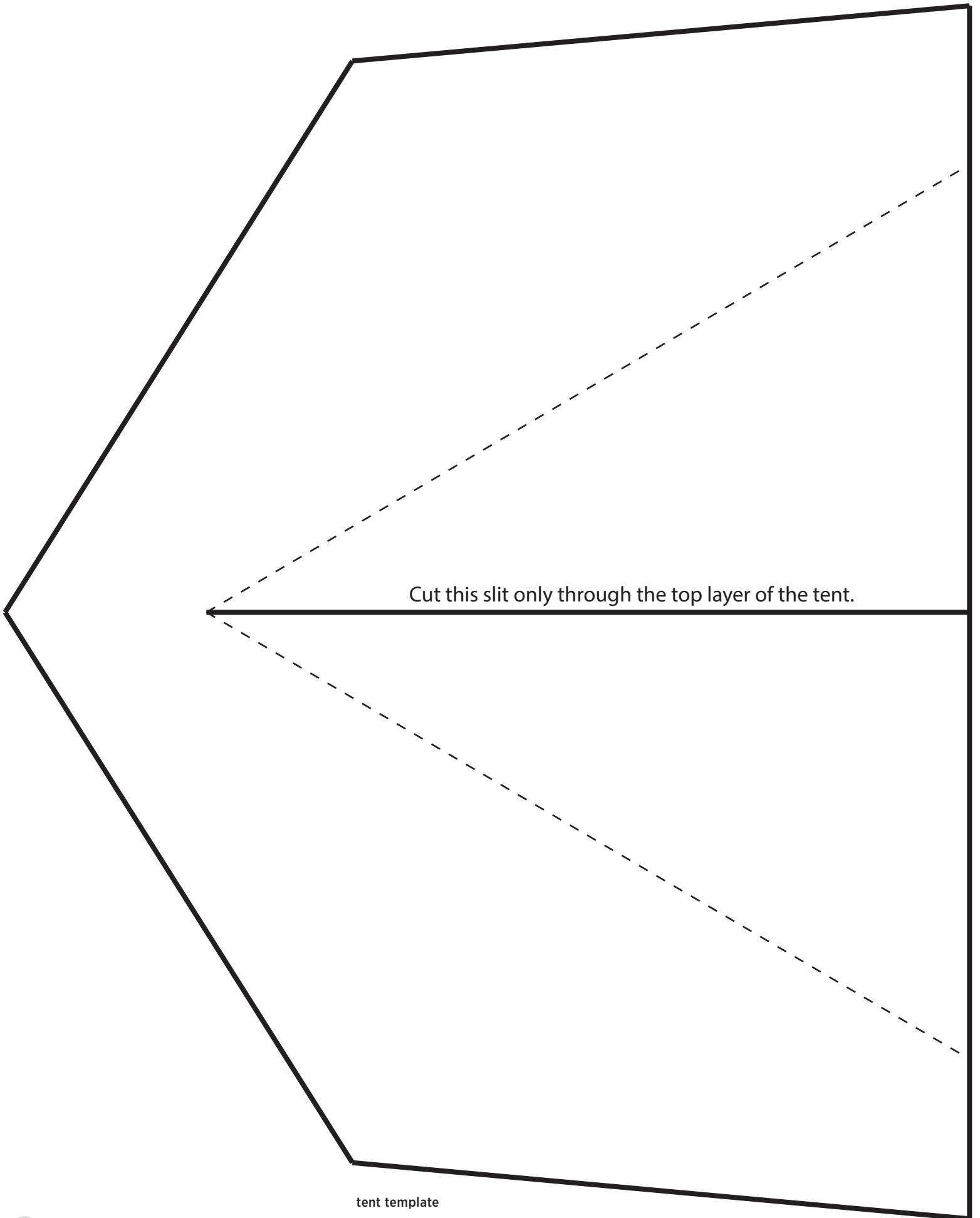

Cut this slit only through the top layer of the tent.

tent template

## GOD TESTS ABRAHAM

*Genesis 22:1-19*

Abraham said, "God will provide for himself the lamb."  
(Gen. 22:8)

### SUPPLIES:

(to make one craft)

- 1 sheet of white cardstock
- templates of altar and ram (see page 26)
- crayons or markers
- scissors
- glue or tape
- optional*: 1 sheet of copy paper

### INSTRUCTIONS:

**PREP STEP:** Copy the altar and ram templates onto cardstock.

*Optional for Step 4:* Copy the illustrated verse below.

1. Color the figures. Cut out the altar (made up of nine small squares), and slit it along the four solid lines. Flip it over and fold inward on all eight dotted lines. Cut out the separate small square with a ram on it.
2. Fasten the sides of the altar to form a cube with a flap: Aligning all edges as you go, glue square **B** onto square **A**. Then glue the flap hanging above it onto square **B**. Spin the altar around and glue the square with the father and son embracing onto square **C**.

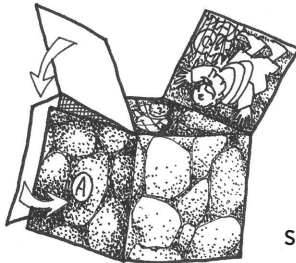

Step 2

3. Firmly crease the edge that attaches the square with "Abraham finding the ram" in both directions so that the square can fold up or down easily. Glue the small ram image onto the flip side of the square with Abraham finding the ram. Now you can fold that flap down to see Isaac on the altar while Abraham discovers the ram, or fold it up to see the ram on the altar while Abraham embraces Isaac.
4. *Optional:* Cut out the verse and glue it to the altar.

**MAKE IT SIMPLE:** Cut and crease each altar, and glue each ram square to the flip side of the Abraham square before class, but leave each altar flat so that it can be colored.

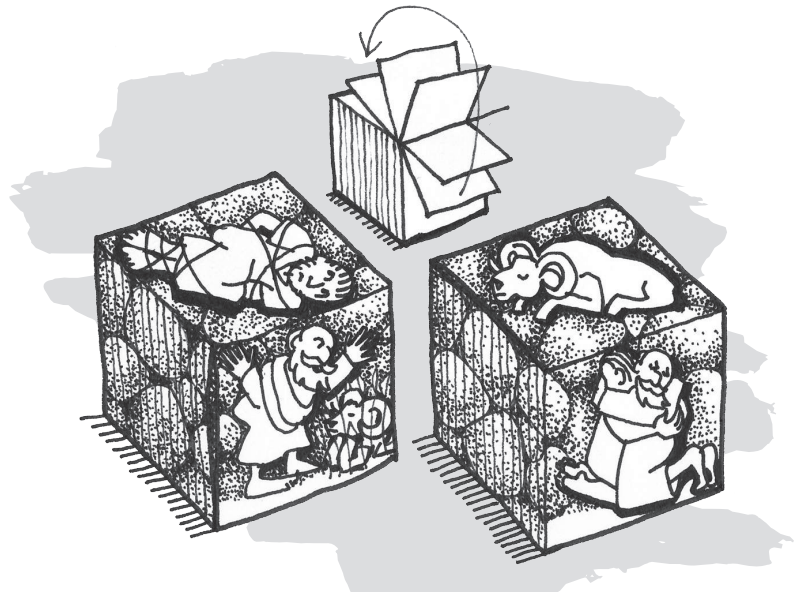
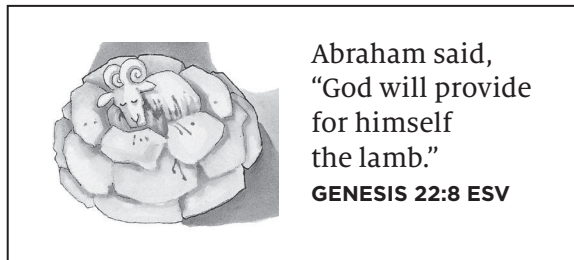





ram template

altar template

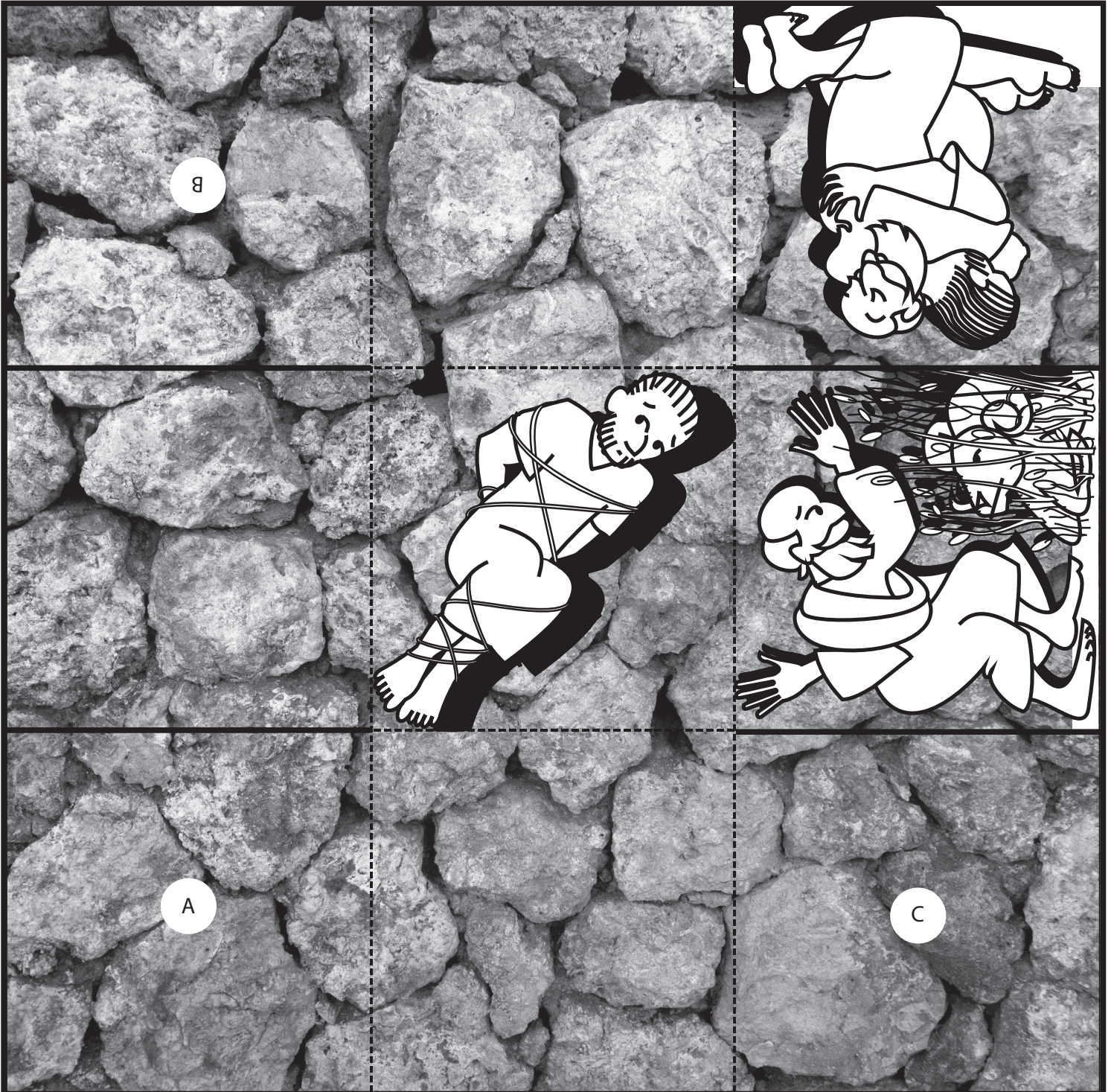



## GOD PROVIDES A WIFE FOR ISAAC

Genesis 24

Delight yourself in the LORD, and he will give you the desires of your heart. (Ps. 37:4)

### SUPPLIES:

(to make one craft)

- 1 sheet of white cardstock
- templates of bracelet designs (see page 28)
- crayons or markers
- scissors
- aluminum foil
- double-sided tape or hot-glue gun
- clear packing tape or several strips of regular tape
- optional*: jewel stickers and/or camel-shaped animal crackers

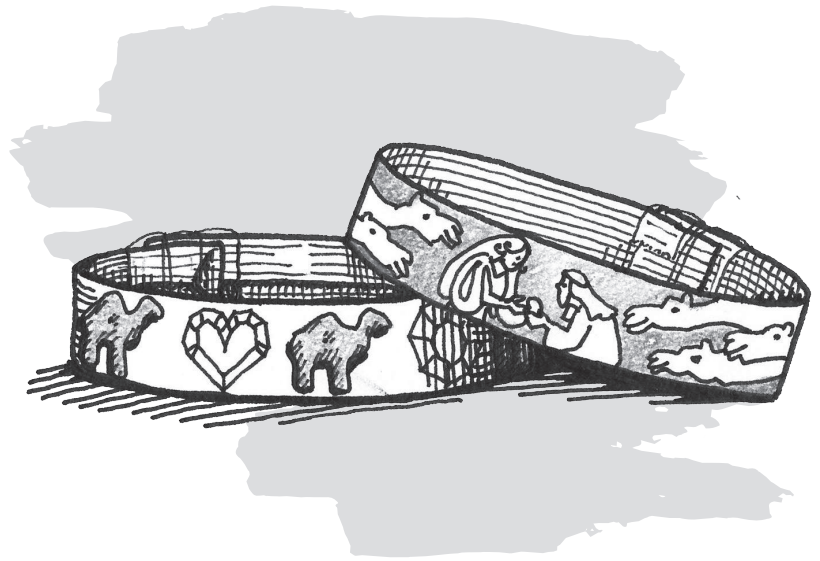

### INSTRUCTIONS:

**PREP STEP:** Copy the bracelet template of Rebekah, the servant, and the camels onto white cardstock. *Optional for Step 4:* Copy additional jewel templates.

1. Color the bracelet and cut it out. Cut out another strip from cardstock of equal size (11 x 1 ¼ inches).
2. Wrap the plain strip of cardstock in aluminum foil and secure the seams with hot glue (with adult assistance) or double-sided tape.

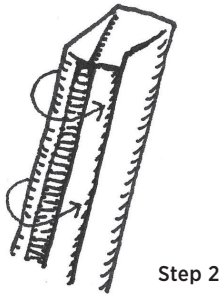

3. Curl the bracelet strips into circles ("silver" bracelet seam-side in) and find the right size to slip easily over your hand. Secure in place with clear packing tape or several strips of regular tape.

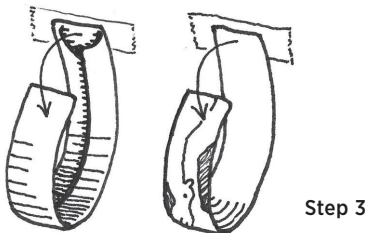

4. Decorate the silver bracelet with any combination of hot-glued camel-shaped animal crackers, jewel stickers, and paper jewels from the templates provided. Decorate further with markers if you wish.
5. *Optional*: Cut out the illustrated verse and paste it to the inside of one bracelet.



**MAKE IT SIMPLE:** Construct the silver bracelets ahead of time at a sufficiently large size to fit the children, and hot glue animal crackers on if you have them. Copy and cut out the bracelets and paper jewels, but allow students to color them while flat and unglued. If need be, skip the silver bracelets altogether.

**MAKE IT AMAZING:** Cut a thin strip of metallic-gold cardstock or paper, and tape it in a small circle to make Rebekah's ring. Cut another 11 x 1 ¼-inch strip of white cardstock and draw on it a picture of Isaac and Rebekah meeting for the first time, then fasten it into a bracelet.



Delight yourself in the LORD, and he will give you the desires of your heart.  
**PSALM 37:4 ESV**

additional jewel templates

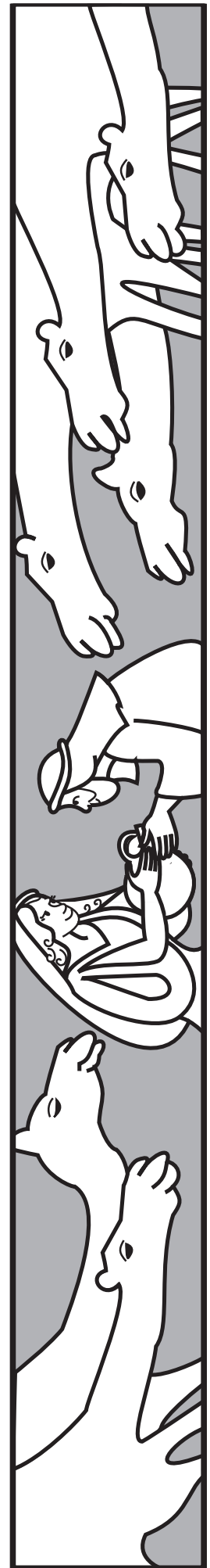
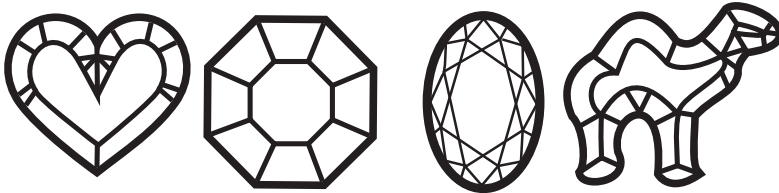

bracelet template

## JACOB DECEIVES ISAAC

*Genesis 27:1–28:5*

Do not lie to one another. (Col. 3:9)

### SUPPLIES:

(to make one craft)

- 1 sheet of white cardstock
- templates of puppet parts (see page 30)
- crayons or markers
- scissors
- 1 paper lunch sack, preferably white
- glue
- two 1 ½ x ½-inch pieces of faux fur (can be cut from discarded clothing or plush animals)
- optional*: 1 sheet of copy paper

### INSTRUCTIONS:

**PREP STEP:** Copy the six puppet-part templates onto white cardstock. *Optional for Step 4:* Copy the illustrated verse.

1. Color and cut out the six puppet pieces. Turn the paper bag to “puppet position” and glue the lower jaw in place, with its top edge all the way up in the crease. Glue the face in position, completely covering the bottom surface of the bag, and aligning the edges that make the top of the mouth.
2. With the bag puppet folded flat, place the arms where you like them, sliding them into the side creases. Glue them only to the surface immediately in front of them so that the bag can still be opened to admit your hand. Color the bag to look like Esau’s stolen clothing.
3. Glue the “hello” badge to puppet Jacob’s chest and the bowl of meat stew to one hand. Glue the strips of fur to puppet Jacob’s arms so that he feels hairy like Esau.
4. *Optional:* Cut out the illustrated verse and glue it to your puppet’s back.

**MAKE IT SIMPLE:** Cut out and glue on the puppet arms and faces ahead of class time. If you have many to make, and the puppet’s face color matches the bag color, consider drawing the lower jaws directly on the bags. Cut out the badges, bowls of stew, and strips of fur before class.

**MAKE IT AMAZING:** Use markers to add details to the clothing such as sleeves, a belt, and a quiver full of arrows. Add more faux fur around the back of puppet Jacob’s neck and chest.

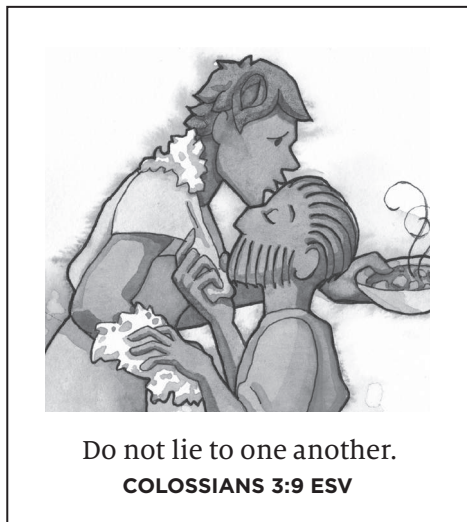

HELLO

my name is

~~Jacob~~  
Esau

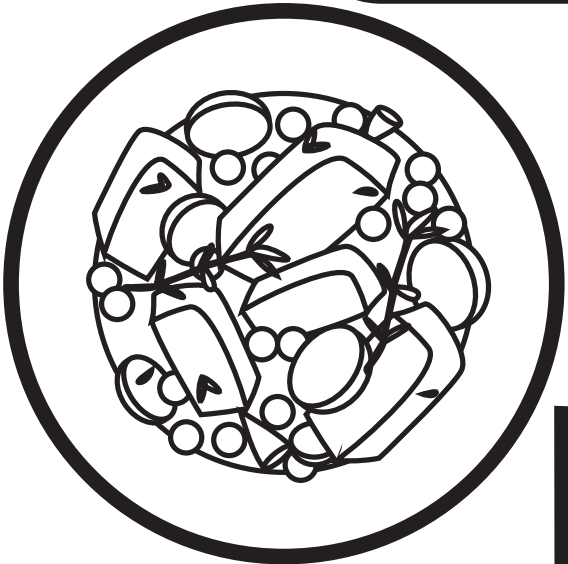
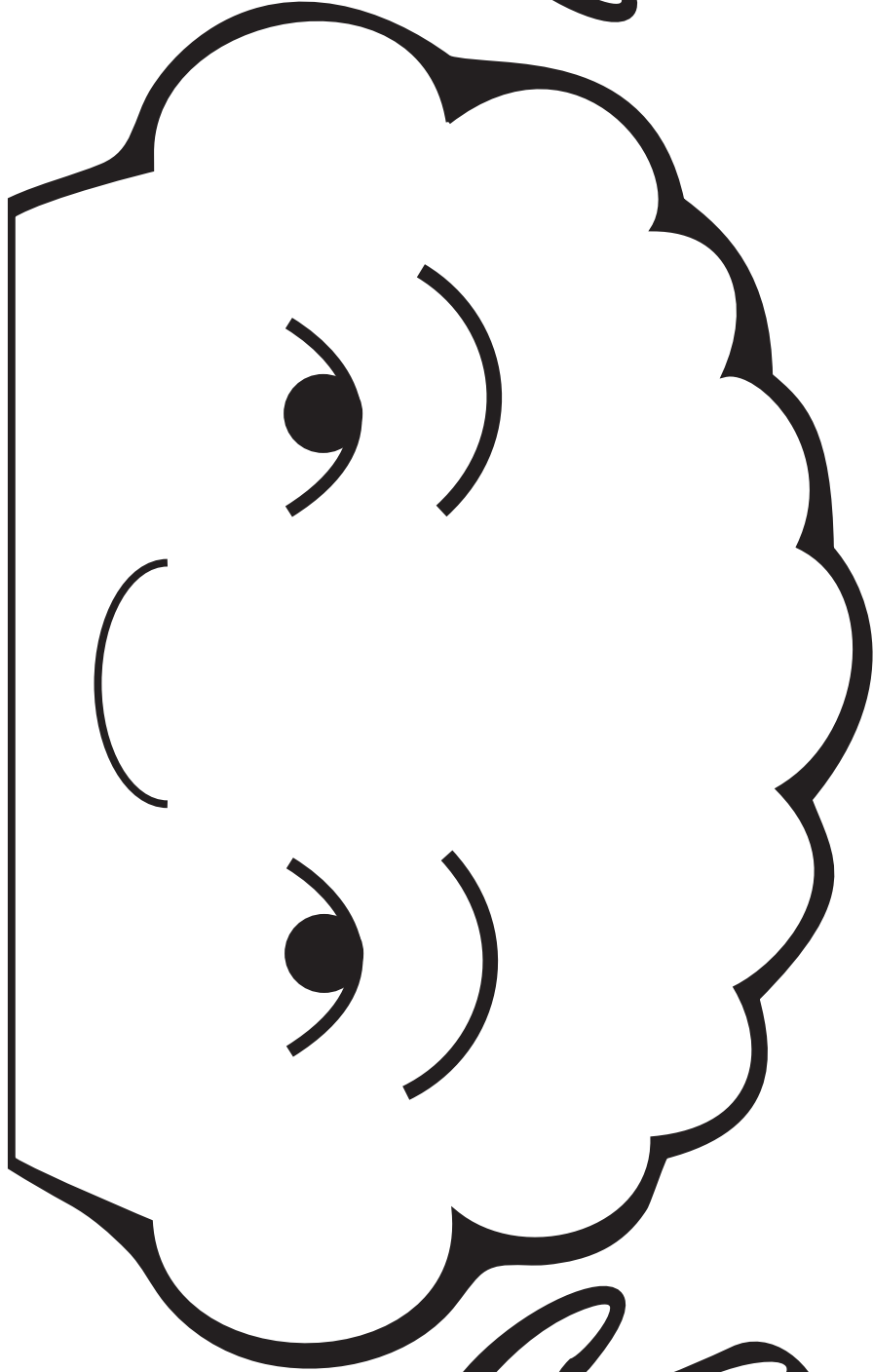
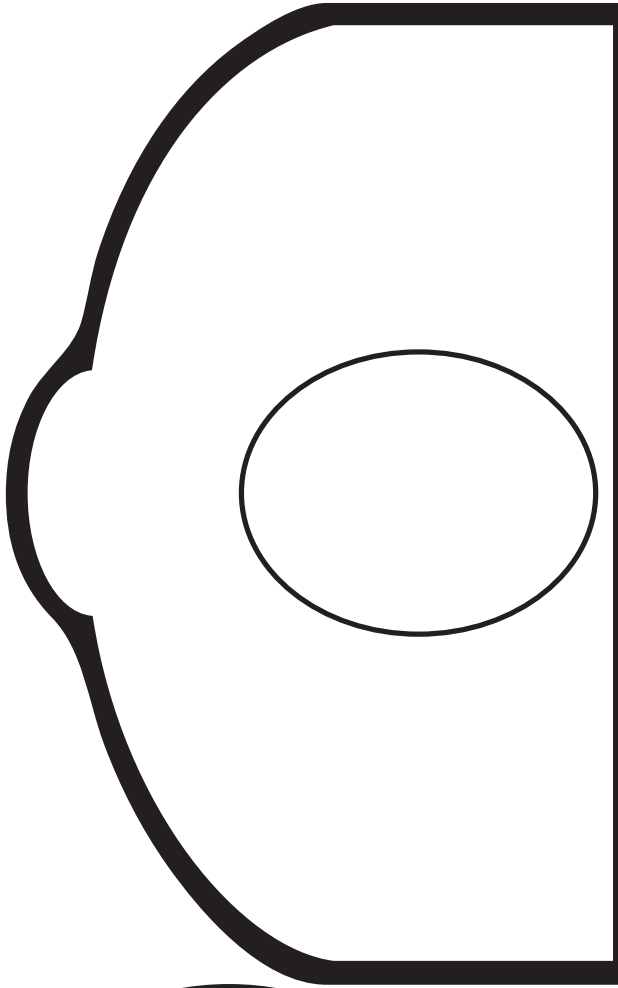

## GOD GIVES JACOB A SPECIAL DREAM

*Genesis 28:10–22*

In all your ways acknowledge him, and he will make straight your paths. (Prov. 3:6)

### SUPPLIES:

(to make one craft)

- 2 sheets of white copy paper
- templates of Jacob, ground, and nine angels (see pages 32–33)
- crayons or markers
- scissors
- 1 sheet of black or dark-blue paper
- tape
- glue
- optional*: foil star stickers

### INSTRUCTIONS:

**PREP STEP:** Copy the Jacob, ground, and angels templates onto white copy paper. *Optional for Step 4:* Make extra copies of angels if you want more than nine angels.

1. Color all the pictures and cut them out.
2. Turn the black or blue “night sky” paper to the “portrait” position and tape the copied picture of the ground to the bottom of it (place the tape on the back side). Glue Jacob sleeping on the ground with his head on the rock.
3. To make a ladder from plain white paper, start with the paper in the portrait position and fold the top half down over the bottom half. Fold the new top half down over the bottom half again, and then again, so that your folded paper, eight layers thick, is 8 ½ inches wide and 1 ¾ inches tall. Cut off a 2-inch length of this folded paper. If making ladders for multiple children, cut four such lengths. Using the diagram as a guide, mark lines on which to cut. Have an adult with adult-sized scissors cut those lines through all eight layers of paper, being careful not to cut past your lines. Then gently unfold your eight-rung ladder.

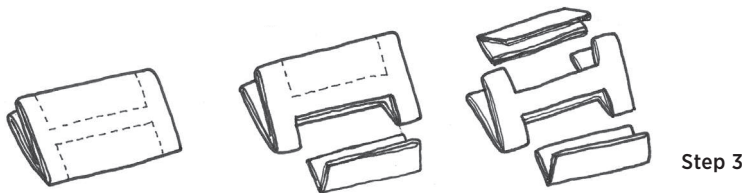

Step 3

4. Center the ladder horizontally on the dark paper, reaching up from the ground. Arrange the angels on and behind it. Glue everything in place.
5. *Optional:* Place foil star stickers in the night sky.
6. *Optional:* Cut out the illustrated verse and paste it to the back of your picture.

**MAKE IT SIMPLE:** Construct the sky and ground scenes, cut the ladders (but let the children unfold them), and cut out Jacob and the angels ahead of time. If your time is limited, cut only three angels per student.

**MAKE IT AMAZING:** Use sandpaper and a flat stone instead of the ground image, and cover Jacob with a blanket made from a piece of fabric.

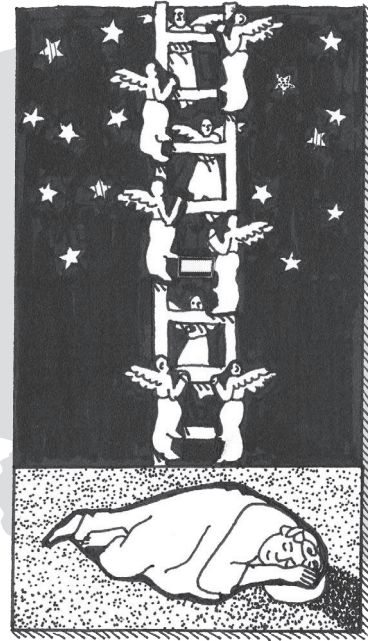





ground template



In all your ways  
acknowledge him,  
and he will make  
straight your paths.  
**PROVERBS 3:6 ESV**





angel templates



Jacob template

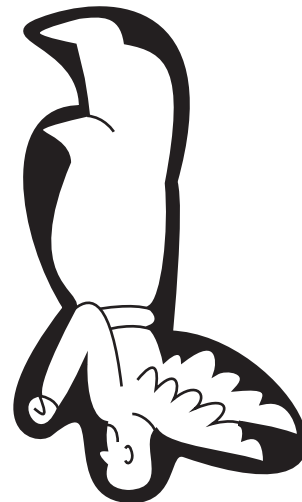
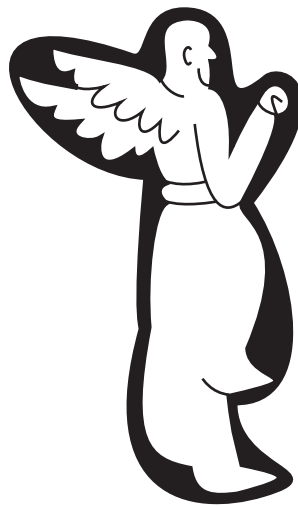
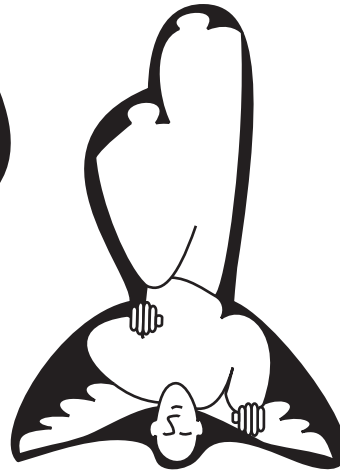

## GOD IS WITH JOSEPH IN EGYPT

*Genesis 37; 39*

Count it all joy, my brothers, when you meet trials of various kinds. (James 1:2)

### SUPPLIES:

(to make one craft)

- 1 sheet of white cardstock
- template of Joseph, his coat, and his prison cell (the full page) (see page 35)
- scissors and *optional* craft knife such as X-Acto™
- crayons or markers
- optional*: tissue paper, felt, ribbon, rickrack, small pom-poms, stickers, etc.
- optional*: glue for decorations
- toothpicks or small strips of cardstock
- tape
- optional*: 1 sheet of copy paper

### INSTRUCTIONS:

**PREP STEP:** Copy the full-page template of Joseph onto white cardstock, being careful to keep the template straight and centered. *Optional for Step 4:* Copy the illustrated verse.

1. Cut out the window opening (using a craft knife if you wish) and the dotted area around the coat. Color the center panel of Joseph.
2. Fold the coat over so that it “fits” Joseph, and color it many colors. If desired, decorate it with the *optional* tissue paper, felt, ribbon, rickrack, small pom-poms, stickers, and/or other colorful supplies. When decorating the coat, you might want to unfold and flip the entire paper over to avoid getting glue or marker on Joseph—just be sure to decorate the correct side of the coat.
3. With strips of tape above and below the window, attach at least four vertical toothpicks or small strips of cardstock to form window bars. Tape them to the printed side of the paper so that when the final panel is folded over in front of Joseph to put him in a prison cell, the tape and ends of the toothpick “prison bars” don’t show.
4. *Optional:* Cut out the illustrated verse and paste it to the back of the center panel.

**MAKE IT SIMPLE:** Cut and crease ahead of time. Cut down coat decorations to usable sizes and remove the sharp tips of the toothpicks.



Count it all joy, my brothers, when you meet trials of various kinds.

**JAMES 1:25 ESV**

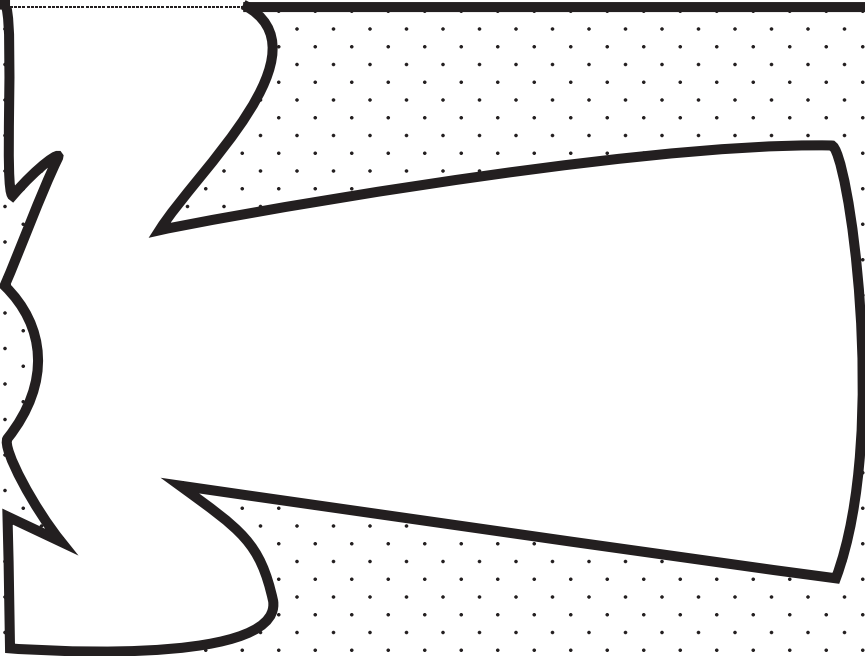
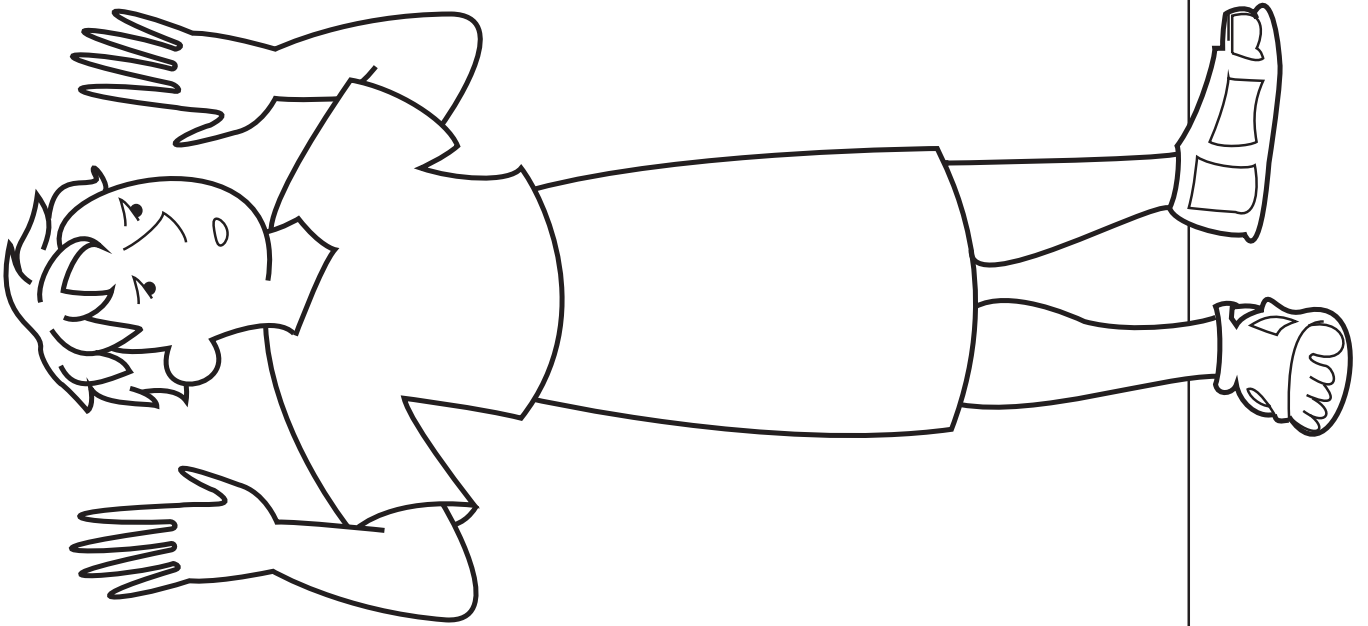
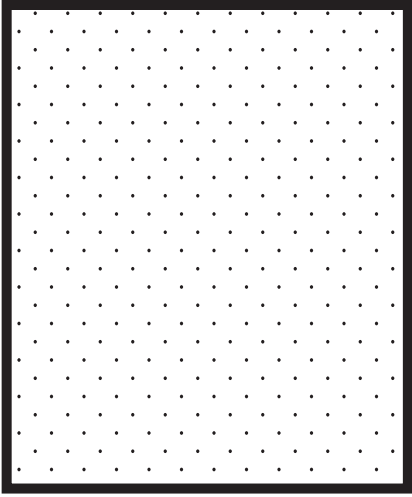

## GOD SAVES HIS PEOPLE FROM FAMINE

*Genesis 41:37–47:12*

God sent me before you to preserve for you a remnant on earth. (Gen. 45:7)

### SUPPLIES:

(to make one craft)

- 1 sheet of white cardstock
- templates of silver cup and of Joseph with his brothers and the sacks (see pages 36–37)
- crayons or markers
- scissors
- glue (a liquid variety)
- uncooked rice, lentils, popcorn, and/or other grains
- 1 sheet of copy paper

### INSTRUCTIONS:

**PREP STEP:** Copy the template of Joseph and his eleven brothers onto white cardstock. Copy the silver cup onto a separate sheet of paper.

1. Color the figures. Cut out the silver cup.
2. *Optional:* Cut out the illustrated verse and paste it to the back of the picture.
3. Cover the “opening” of each empty sack with liquid glue, then cover the glue with uncooked rice, lentils, popcorn, and/or other grains. Choose one sack to be Benjamin’s and glue the silver cup into his sack with the grains.
4. Let the glue dry completely, then shake any loose grains into a garbage can.

**MAKE IT SIMPLE:** Paste verses to the backs of the pictures and write students’ names before you begin to glue on the grains. Pour your grains into small cups so that they can be easily passed around and applied to the pictures. Use liberal amounts of glue, and make sure the pictures stay flat to dry.

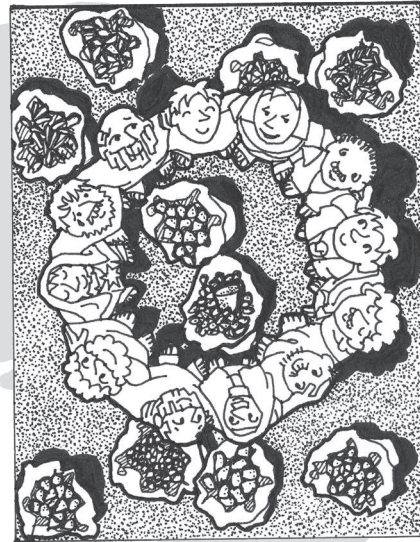

God sent me before you to preserve for you a remnant on earth. **GENESIS 45:7 ESV**



silver cup template



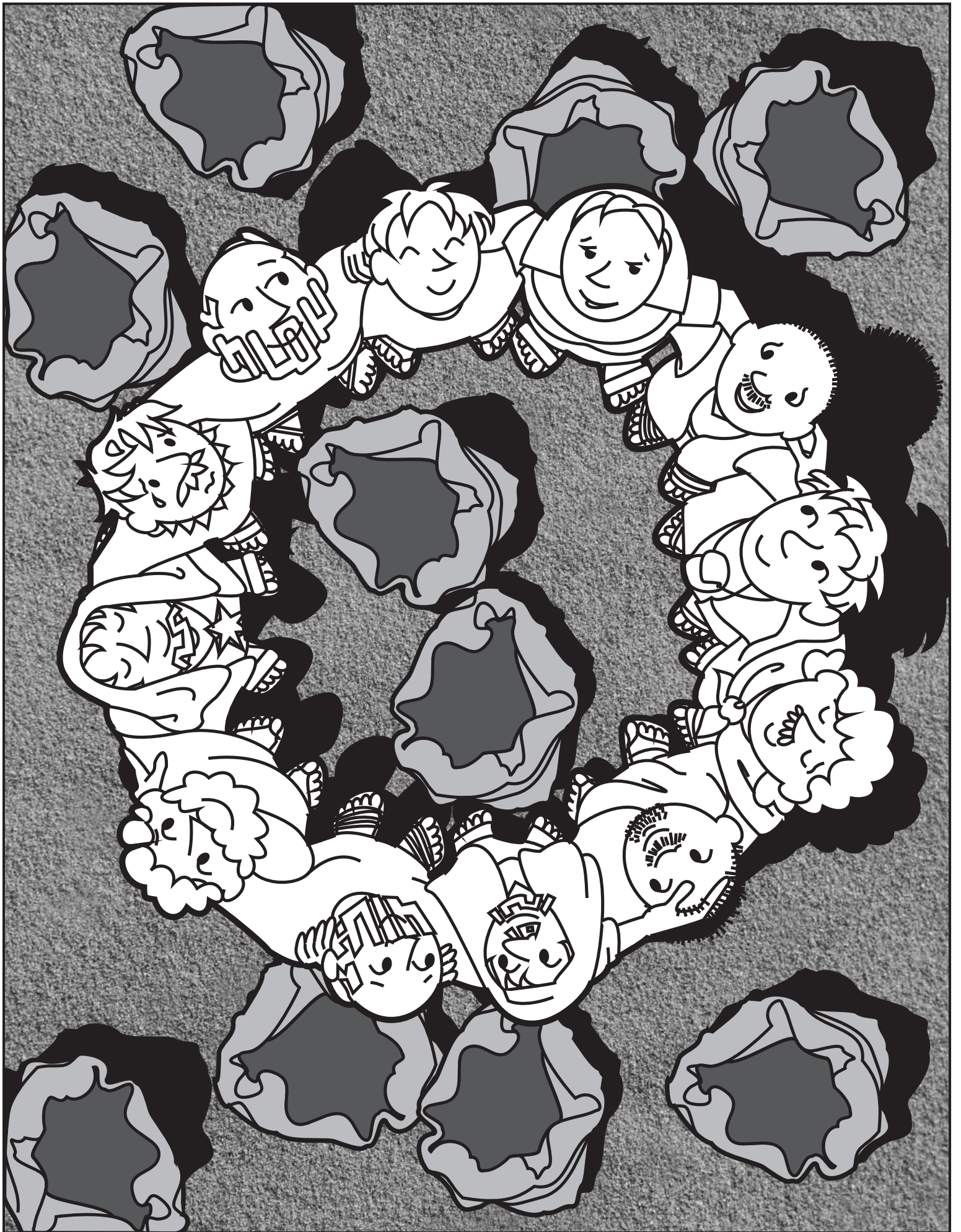



## GOD PRESERVES BABY MOSES

*Exodus 2:1-10*

The LORD will not forsake his people. (Ps. 94:14)

### SUPPLIES:

(to make one craft)

- 1 sheet of white copy paper
- template of baby Moses (see page 39)
- 1 sheet of blue cardstock or paper
- 1 sheet green paper
- scissors
- tape
- crayons or markers
- 1 paper cupcake liner
- glue

### INSTRUCTIONS:

**PREP STEP:** Copy the baby Moses template onto white paper.

1. Cut the blue cardstock in half widthwise or fold blue construction paper in half widthwise and glue it closed. This will be the water.
2. Cut the green paper lengthwise and widthwise to make four 4 ½ x 5 ½-inch sheets. Stack them atop one another, then fold them in half lengthwise. Unfold them and cut them, still stacked, with a row of fringe as shown. Make cuts parallel to the short edge with each cut running from the long edge to the crease.

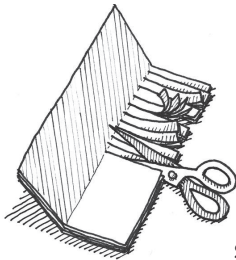

Step 2

3. Separate the fringed green sheets and roll each one up to create papyrus plants with tightly rolled “stems” capped by pom-pom-like tops. Secure them with tape.

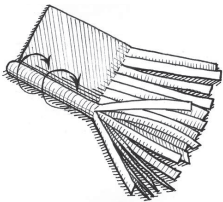

Step 3

4. Color baby Moses and cut him out. Fit him into the bottom of a paper cupcake liner “basket,” and color it if you wish.
5. Arrange the papyrus plants and floating basket on the paper water and secure them with glue and/or tape. Draw a few rings or partial rings around the basket and each “plant” to look like ripples in the surface of the water.
6. *Optional:* Cut out the illustrated verse and glue it to the water.

**MAKE IT SIMPLE:** Trace students’ hands with their fingers spread wide onto the green paper. Cut out the handprints (several at once), fold up the bottom ¼-inch of each to form bases, and fasten them to the water instead of constructing the papyrus plants.

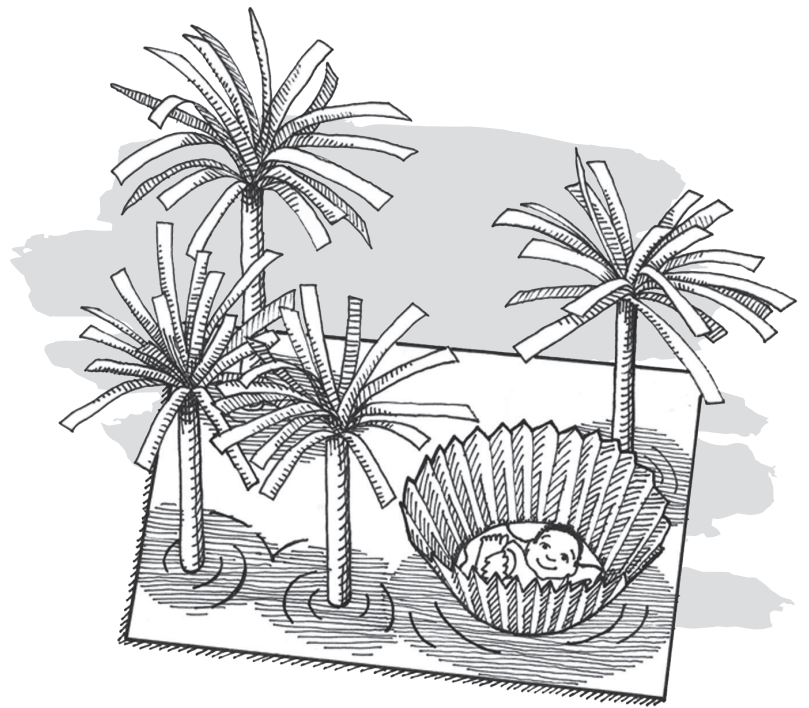



baby Moses template



The LORD will not forsake  
his people. **PSALM 94:14 ESV**

## GOD CALLS MOSES TO DELIVER HIS PEOPLE

*Exodus 2:23-4:17*

Then the LORD said, "I have surely seen the affliction of my people who are in Egypt. . . . I know their sufferings." (Ex. 3:7)

### SUPPLIES:

(to make one craft)

- 1 sheet of brown paper
- a writing utensil
- at least 2 sheets of green paper
- scissors
- 1 background sheet of any color paper
- glue
- red, orange, and yellow tissue paper
- optional*: 1 sheet of copy paper



### INSTRUCTIONS:

**PREP STEP:** *Optional for Step 5:* Copy the illustrated verse.

1. Trace your hand with fingers spread wide, and including a bit of forearm, onto brown paper. Place the brown paper on top of at least two sheets of folded green paper and cut the hand shape out of all layers of paper simultaneously. Cut the forearm "trunk" shape off of the green, hand "leaf" shapes.
2. Arrange the green hand shapes behind the brown finger shapes to look like a bush with green leaves, and glue them onto a background sheet of paper of any color.
3. Align several layers of red, orange, and yellow tissue paper atop one another, mark a rough 6- to 9-inch square on the top layer, and cut the square out of all the layers of tissue paper at once. Repeat this step until you have at least twelve tissue paper squares.
4. Pinch each tissue paper square an inch below its center and pull all the corners and edges away from the pinch, to make tufts of "flames." Glue, tape, or staple the tufts around the branches and leaves of the bush.
5. *Optional:* Cut out the illustrated verse and paste it to your "burning bush."

**MAKE IT SIMPLE:** Trace and label students' hands as they enter class, then have an assistant cut them out during story time. Have tissue paper cut to size before class.

**MAKE IT AMAZING:** Instead of brown paper, use a paper towel tube to create a three-dimensional burning bush. Cut five or six parallel 2-inch slits up from the bottom of the tube, roughly an inch apart. Fold the resulting "roots" up 90 degrees and use them to fasten the bush to a cardstock or cardboard base. Cut nine longer parallel slits down from the top of the tube, roughly  $\frac{3}{4}$  inch apart, varying from 4  $\frac{1}{2}$  to 5  $\frac{1}{2}$  inches long. Gently curve the resulting "branches" out from the trunk, then fasten several green handprint-clusters of leaves onto and between the branches. Finally, fasten tissue paper tufts of flame within the branches and leaves.

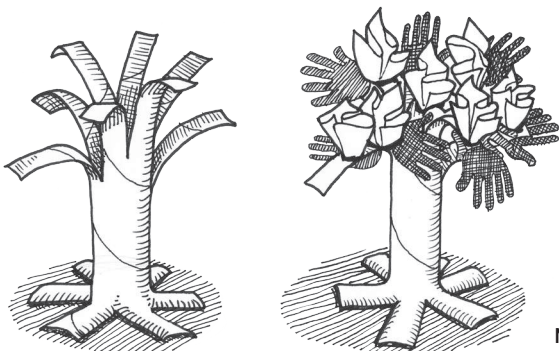

Make It Amazing



Then the LORD said,  
“I have surely seen the  
affliction of my people  
who are in Egypt. . . .  
I know their sufferings.”

**EXODUS 3:7 ESV**

## GOD GIVES HIS PEOPLE THE SIGN OF BLOOD

*Exodus 11–12*

Blood shall be a sign for you . . . and when I see the blood, I will pass over you. (Ex. 12:13)

### SUPPLIES:

(to make one craft)

- 1 sheet of white or tan cardstock
- 1 sheet of white paper
- templates of the Israelite house (the full page) and of the mother and daughter (see pages 42–43)
- scissors
- crayons or markers
- glue
- red paint or red marker

### INSTRUCTIONS:

**PREP STEP:** Copy the full-page template of the Israelite house onto white or tan cardstock. Copy the mother and daughter template onto white paper.

1. Fold the Israelite house in half and color the figures. Cut the side and top of the door along the bold line, then fold it open and crease it along the dotted line.
2. Color the mother and daughter and cut them out. Glue them inside the house so that they can at least be partially seen when the door is open.
3. Use red paint or a red marker to place “blood” on the two doorposts and lintel.
4. *Optional:* Cut out the illustrated verse and paste it to the back of the house.

**MAKE IT SIMPLE:** Copy and fold the houses ahead of time, leaving the doors for the children to cut and crease if they are capable. Copy and cut out the mother and daughter.

**MAKE IT AMAZING:** Draw additional people, animals, and/or furniture inside and outside of the house. Cut out the back window and draw a person inside the house looking out.

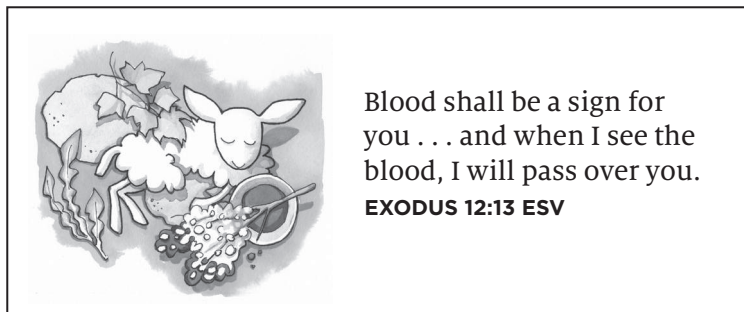
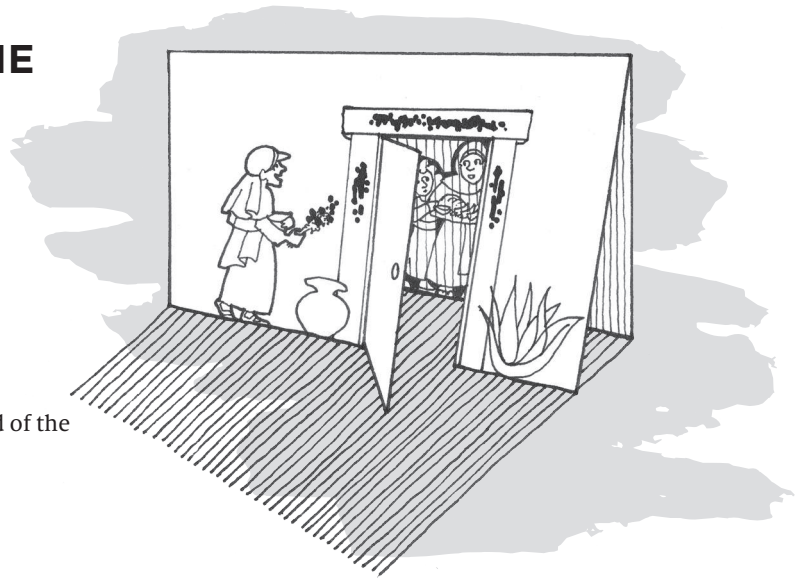

mother and daughter template



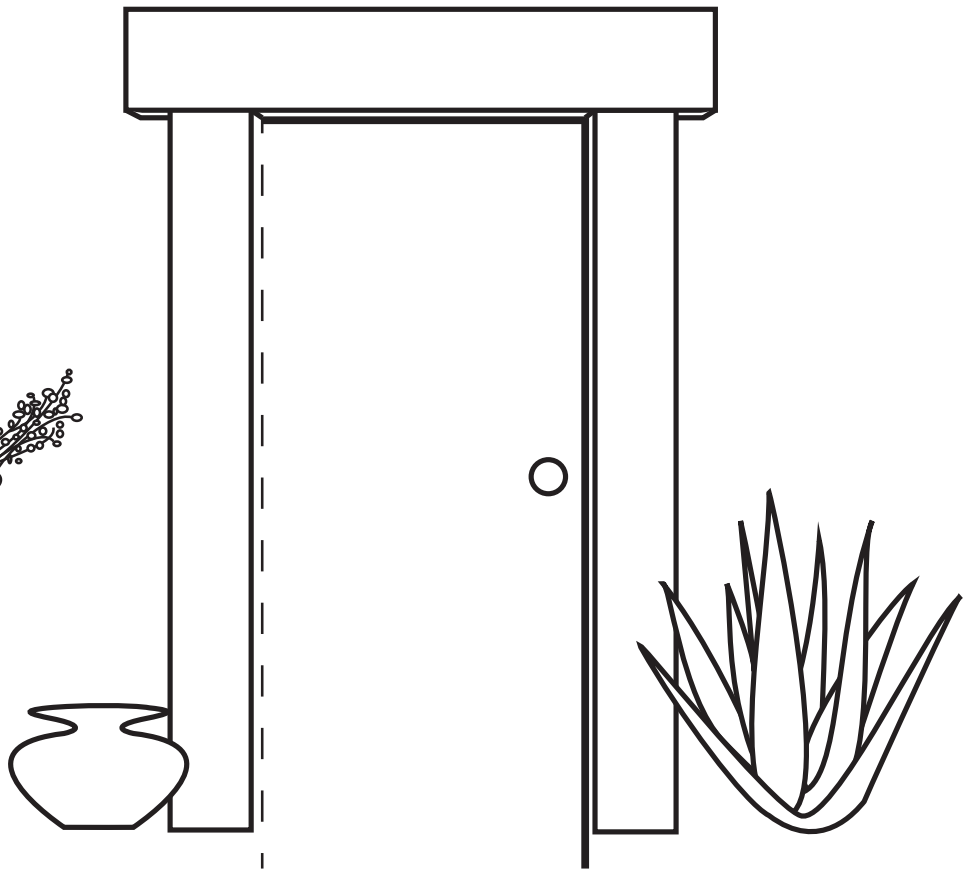
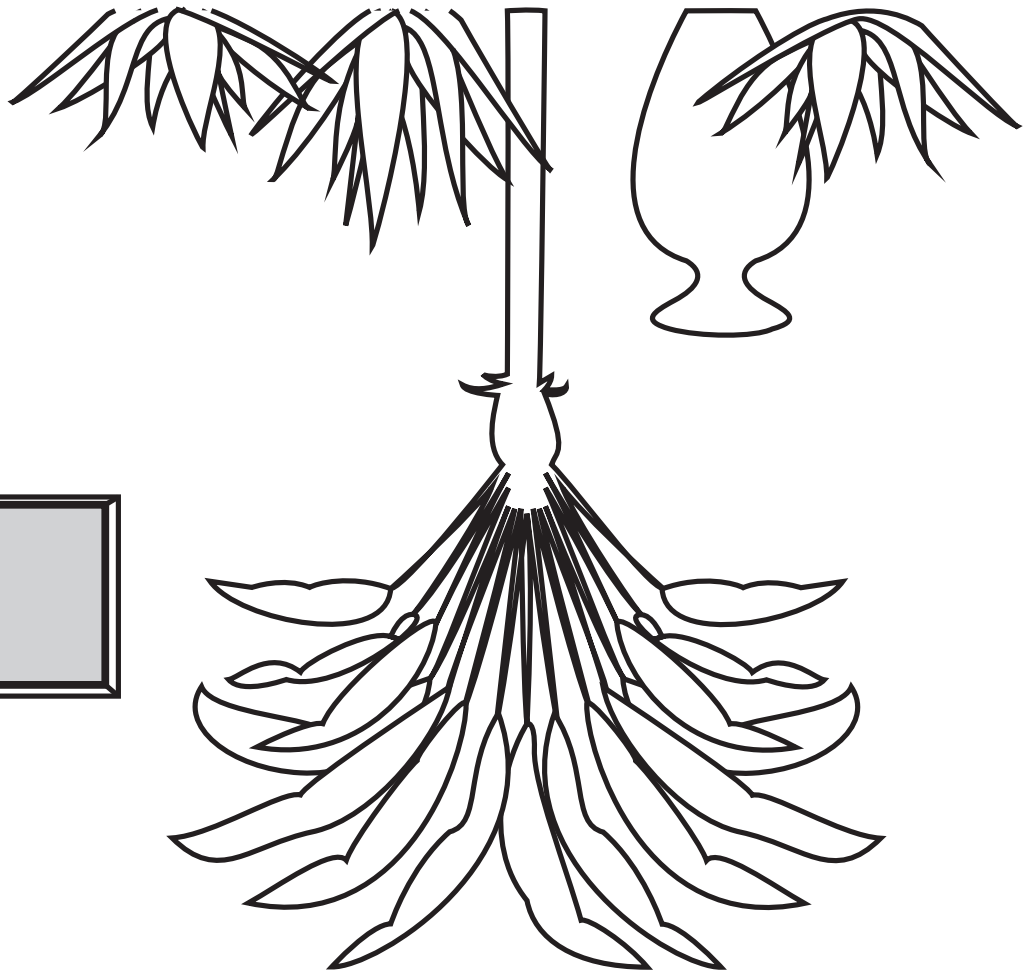

## GOD DELIVERS HIS PEOPLE FROM SLAVERY

*Exodus 14*

You have led in your steadfast love the people whom you have redeemed. (Ex. 15:13)

### SUPPLIES:

(to make one craft)

- 1 sheet of white cardstock
- templates of Israelites and waves (see page 46)
- 1 sheet of blue paper
- scissors
- 1 sheet of brown paper or brown paper bag
- glue
- crayons or markers
- Optional:* 1 sheet of copy paper

### INSTRUCTIONS:

**PREP STEP:** Copy the Israelite template onto white cardstock. *Optional for Step 6:* Copy the illustrated verse.

1. Cut a wave pattern into the long sides of a full sheet of blue paper (using the provided template if desired).
2. Cut a rectangle out of brown paper 3 inches wide and as long as your blue paper (standard-size copy paper is 11 inches long, while construction paper is usually 12 inches long).
3. Glue the brown paper lengthwise onto the center of the blue paper. Then fold the uncovered blue-paper waves up 90 degrees. This should form a brown “dry land” path with walls of blue “water” standing up on both sides.
4. Color the Israelites and cut out the entire rectangle as one piece. Fold on the two dotted lines to form a double-sided strip of Israelites with two tabs at the bottom folded inward.

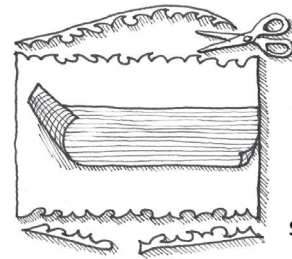

Steps 1, 2, and 3

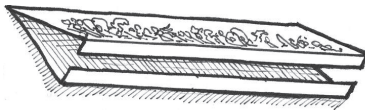

Step 4

5. Glue one tab over the other to create a standing base for the strip of Israelites, then glue the strip down by its base onto the center of the path.
6. *Optional:* Cut out the illustrated verse and glue it to the outside of one wall of water.

**MAKE IT SIMPLE:** Cut and fold everything before class. Unfold to color (creases will help the construction go faster after coloring).

**MAKE IT AMAZING:** Use actual sandpaper for the dry ground. Use oil pastels or crayons to draw fish and seaweed in the water.

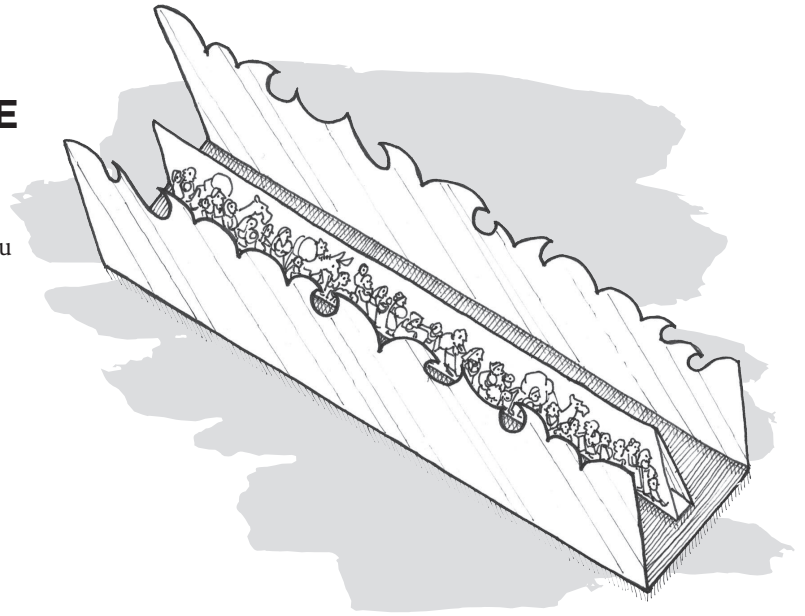

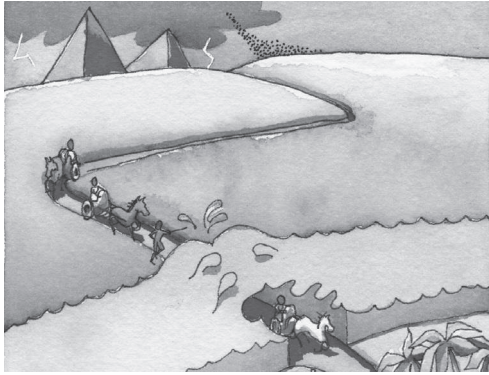

You have led in your steadfast love  
the people whom you have redeemed.  
**EXODUS 15:13 ESV**



waves template

Israelite template

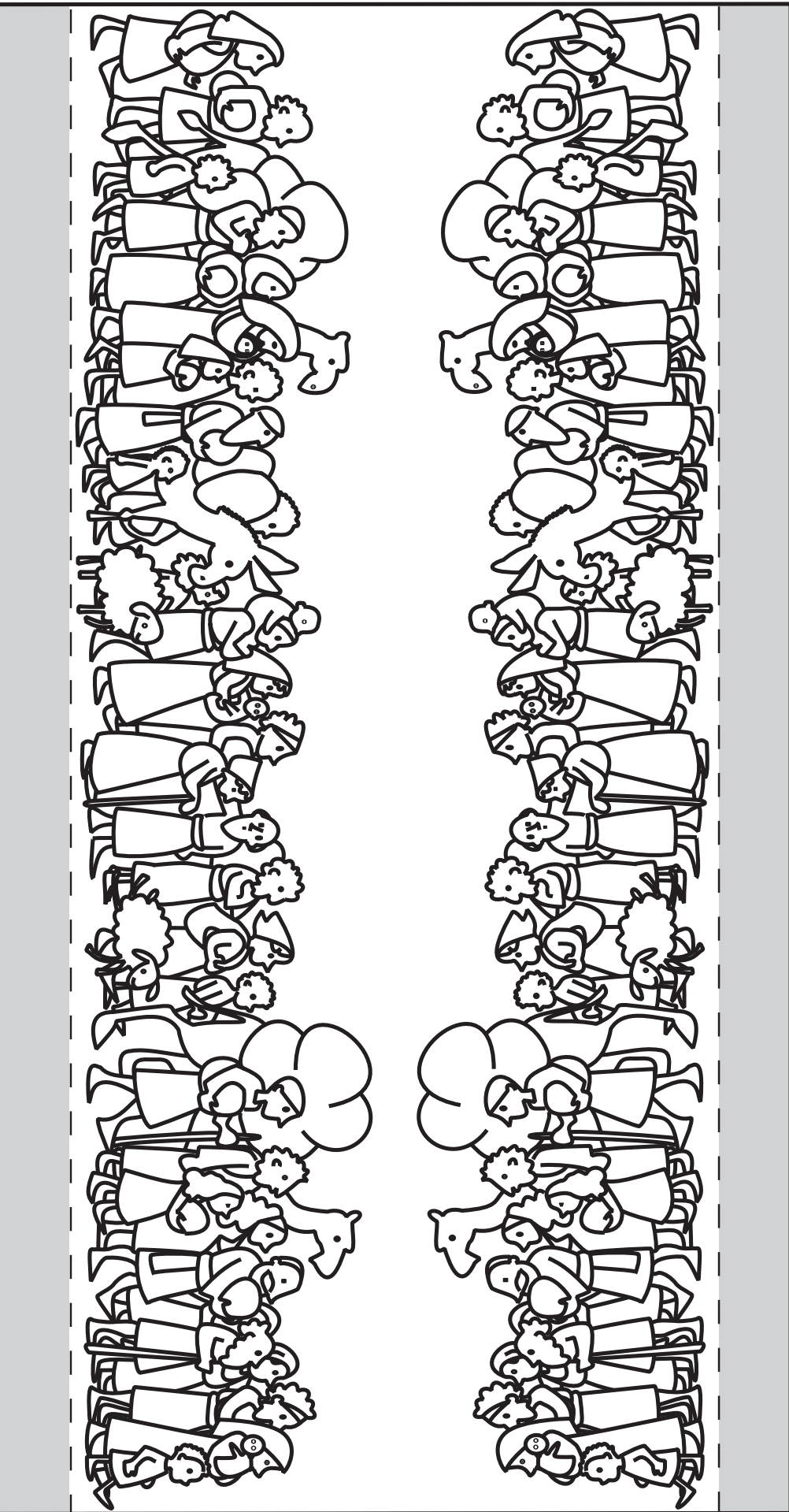



## THE ISRAELITES PRAISE AND THANK GOD

*Exodus 15:1-21*

I will sing to the LORD, for he has triumphed gloriously.  
 (Ex. 15:1)

### SUPPLIES:

(to make one craft)

- 1 sheet of white copy paper
- template of Miriam (see page 48)
- crayons or markers
- scissors
- 2 disposable pie tins or plastic plates
- glue
- hole punch
- 16–32 feet of curling ribbon
- optional*: chenille stems (pipe cleaners)
- a few craft bells or a small handful of uncooked pasta such as macaroni or rotini
- optional*: stickers

### INSTRUCTIONS:

**PREP STEP:** Copy the template of Miriam onto white paper.

1. Color Miriam and cut out the circle around her. Glue it to the bottom of one of the tins.
2. Align the tins, insides together, rim to rim, and use the hole punch to make four to eight evenly spaced holes through both rims.
3. a. Thread a 4-foot length of curling ribbon through an aligned set of holes and knot the ribbon so that it holds the tins together. Cinch the knot right next to the tins and centered in the ribbon so that about 2 feet of ribbon trails from each side of the knot.  
 b. *Optional (if small fingers struggle to thread the ribbon through the holes):* Use chenille stems to hold the tins together. Twist the stem closed once it has passed through both tins, then tie or twist the length of ribbon into the stem. This method can be used to attach craft bells as well, which are especially desirable if you are using plastic plates instead of tins. Have an adult trim the chenille stems and fold the sharp tips back.
4. Fasten half of the holes together, then, if you are not using bells, place a handful of uncooked pasta inside your “tambourine.” Continue fastening the holes with ribbon or chenille stems the rest of the way around.
5. *Optional:* Decorate the rest of the tambourine with stickers and/or markers.

**MAKE IT SIMPLE:** Punch all holes ahead of time, cut ribbon to 4-foot lengths, and fasten one set of holes together on each tambourine.

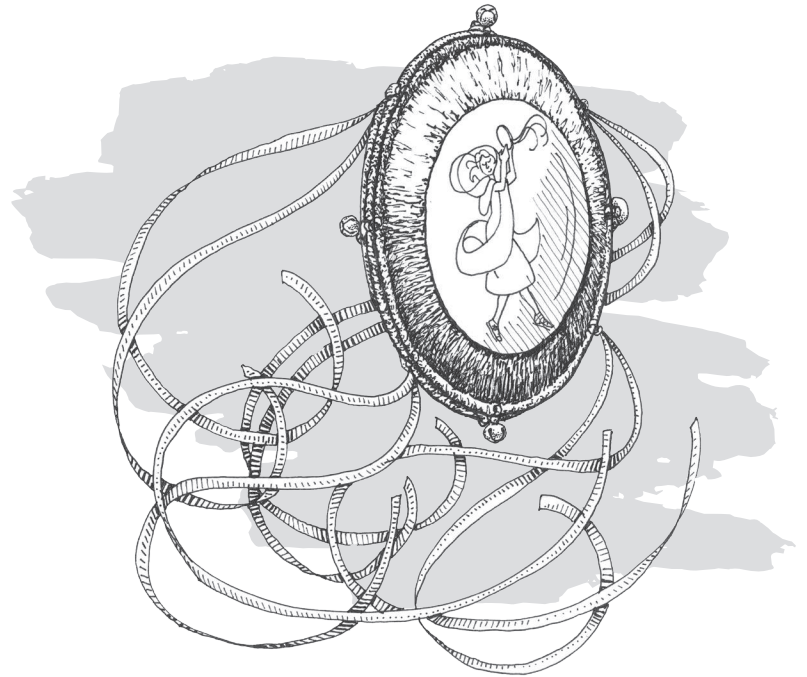



Miriam template

## GOD PROVIDES FOOD IN THE WILDERNESS

*Exodus 16*

At twilight you shall eat meat, and in the morning you shall be filled with bread. Then you shall know that I am the LORD your God. (Ex. 16:12)

### SUPPLIES:

(to make one craft)

- 1 brown paper lunch sack
- scissors
- stapler
- crayons or markers
- oyster crackers, Frosted Flakes®, Nilla Wafers®, foam peanuts, saltine crackers, torn stale tortilla, white paper, or any other material that might resemble manna
- a 6-inch paper plate
- 1 sheet of white copy paper
- template of quail silhouette (see page 50)
- optional: black craft feathers
- glue
- 1 black crayon or marker
- optional: small googly eyes

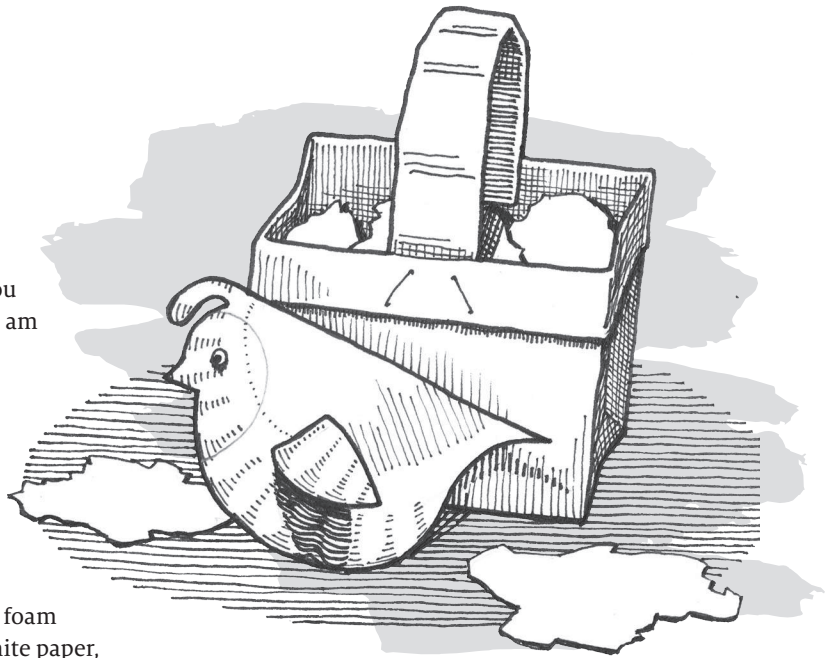

### INSTRUCTIONS:

If you are a teacher or parent, you may want to have your children “gather manna” (with strict instructions not to eat it) during this craft. Before class, choose a section of the room with no foot traffic and spread your chosen form of “manna” on the ground, to be collected by the children and placed in their baskets. (If you want to allow them to eat it, spread it on a clean tablecloth.)

**PREP STEP:** Copy the quail template onto white paper.

1. Cut the top 5-inches off a brown paper lunch sack. Open what is left of the bag and fold the top inch out and down all the way around, as if folding down a turtleneck. Crease, fold this new rim out and down a second time, and crease again. This will stabilize the “basket” and help it stay open. Create a basket handle from the part of the bag you cut off: Without cutting it further, open the circle of paper, then flatten it so that it is roughly 5 x 10 inches. Roll it or fold it several times lengthwise so that it is still 10 inches long, but now only 1–2 inches wide. Staple the ends of your handle inside the rim of your basket on opposite sides as shown. Color the basket if you wish.

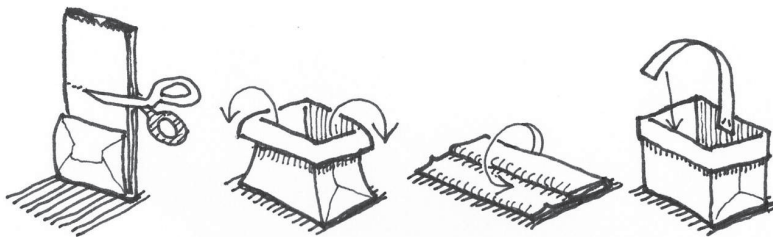

Step 1

2. *Optional:* Direct the children to go collect “manna.”

3. Fold the paper plate in half, with the eating surface of the plate inside. Cut out the quail semicircle, align it over the folded plate, and cut along the silhouette lines, through the image and both layers of plate at once. If you have craft feathers, cut off the paper “head feather” and glue a craft feather in its place. The teardrop-shaped sections of plate cut away from the quail’s tail (shaded gray on the template) will become its wings. Fold both sections in half crosswise, then glue their narrow halves to the quail’s sides so that their wider halves stick out like wings. Run a strip of glue inside the plate rim to fasten the quail stomach closed. Color the face and head feather black, then glue on googly eyes if desired. Color the rest of the quail as you wish. It will fit in the basket with the manna.

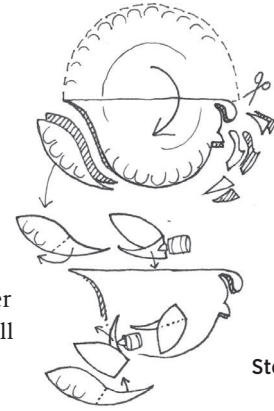

Step 3

4. *Optional:* Cut out the illustrated verse and glue it to your basket.

**MAKE IT SIMPLE:** Construct the baskets ahead of time with the exception of attaching the handles. Construct the quails ahead of time with the exception of attaching the wings and eyes. Outline the face section to be colored black. If you are hard pressed for time, skip the quails.

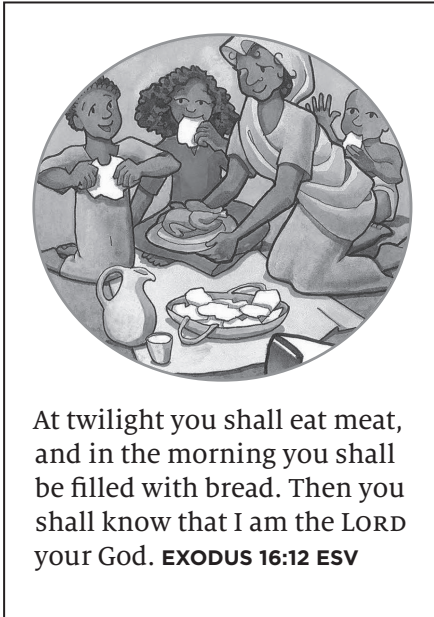

At twilight you shall eat meat,  
and in the morning you shall  
be filled with bread. Then you  
shall know that I am the LORD  
your God. **EXODUS 16:12 ESV**

quail silhouette template





## GOD GIVES ISRAEL VICTORY OVER THE AMALEKITES

*Exodus 17:8-16*

I call upon the LORD, who is worthy to be praised, and I am saved from my enemies. (Ps. 18:3)

### SUPPLIES:

(to make one craft)

- 1 sheet of white cardstock
- Moses template (see page 52)
- crayons or markers
- scissors
- a 12-inch chenille stem (pipe cleaner)
- tape
- a 6-inch twig, bamboo skewer, or a piece of tightly rolled brown paper

### INSTRUCTIONS:

**PREP STEP:** Copy the Moses template onto white cardstock.

1. Color Moses, fold him in half along the dotted line, and cut him out, including cutting around the oval bit where his shoulder meets the crease.
2. Open the crease and thread the pipe cleaner through the slit at the shoulder. Center the pipe cleaner horizontally along Moses's shoulder line and fasten it in place using a vertical 2-inch piece of tape (running from his head to his chest). Make the tape just loose enough that the pipe cleaner can twist in place. Close the front and back halves of Moses together and tape shut.
3. Bring Moses's arms forward and wrap the "hand" ends around the twig, bamboo skewer, or tightly rolled brown paper, which is acting as his staff. You should now be able to gently make Moses raise and lower his arms and staff.
4. *Optional:* Cut out the illustrated verse and tape it to Moses's back.

**MAKE IT SIMPLE:** Cut out Moses and fasten one end of a pipe cleaner to each stick (but not to Moses) before class. After you thread his arms through the shoulder slit, they will already be holding his staff in one hand, ready to be fastened to the other hand with tape.

**MAKE IT AMAZING:** Fashion sleeves for Moses out of little tubes of paper that run from his shoulders to his wrists. (The part of the pipe cleaner that is inside him must remain free to spin under the tape.)

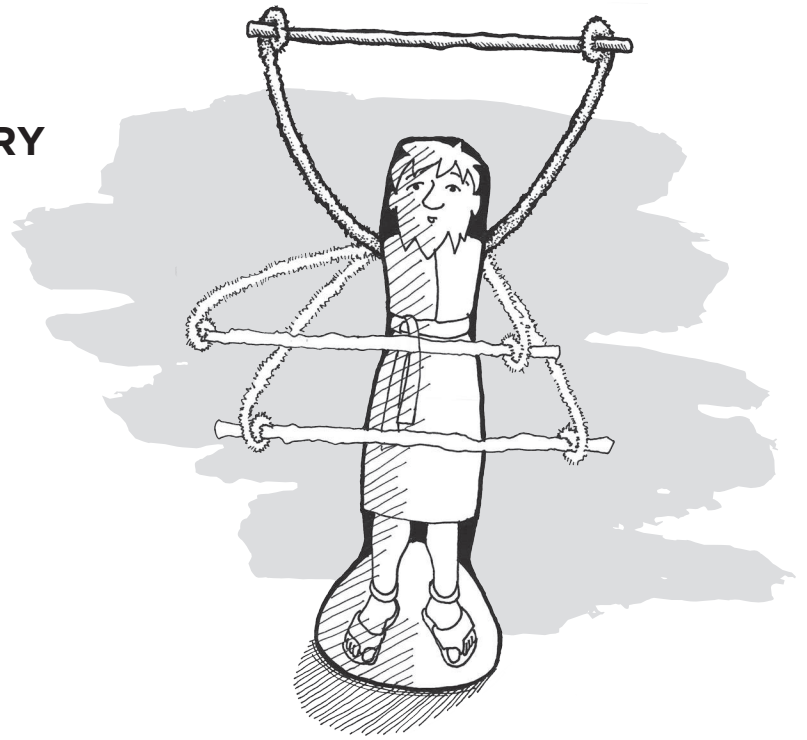

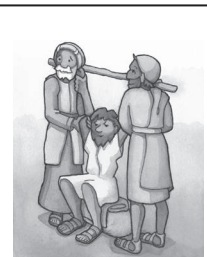
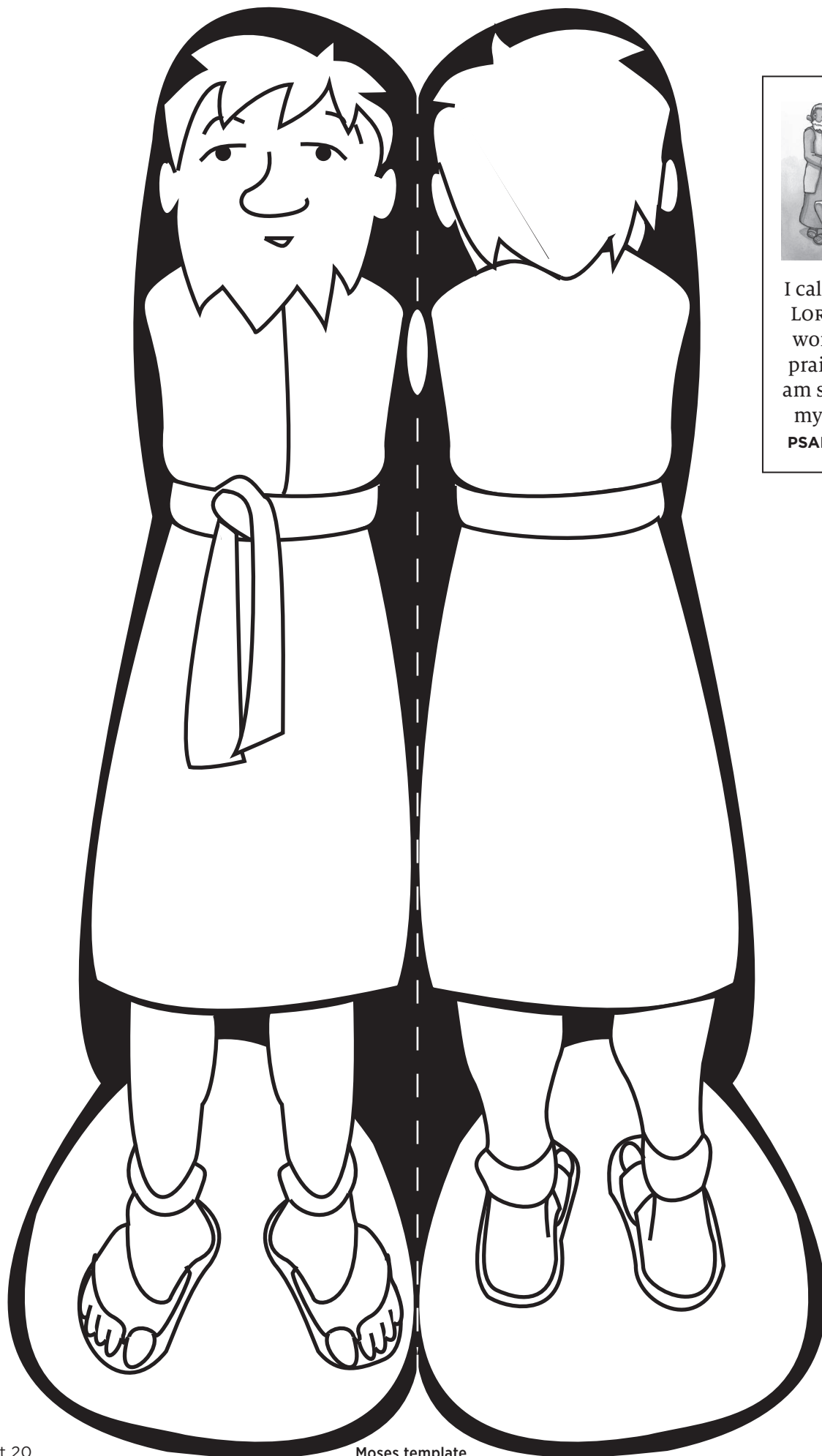

I call upon the  
LORD, who is  
worthy to be  
praised, and I  
am saved from  
my enemies.

**PSALM 18:3 ESV**

## GOD PROVIDES THE LAW (AND THE ISRAELITES REJECT HIM)

*Exodus 19:1-20:21; 24:12-18; 32:1-20*

I am the LORD your God. . . . You shall have no other gods before me. (Ex. 20:2-3)

### SUPPLIES:

(to make one craft)

- gray clay: Crayola® Model Magic® (to use during craft time) or any polymer or modeling clay (to prepare ahead of time)
- masking tape
- 1 sheet of white cardstock
- template of Moses and the Israelites (see page 54)
- crayons or markers
- scissors and/or optional craft knife such as X-Acto™
- 1 sheet of construction paper, any color
- 1 cow-shaped animal cracker
- metallic-gold paint
- hot-glue gun or glue
- optional: permanent black marker
- optional: 1 sheet of copy paper

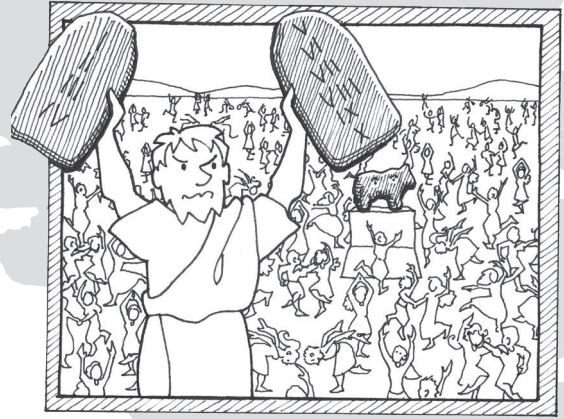

### INSTRUCTIONS:

**PREP STEP:** Copy the template of Moses and the Israelites onto white cardstock. *Optional for Step 6:* Copy the illustrated verse.

1. Create “stone tablets” from gray clay. If you use Crayola® Model Magic®, you can form the tablets on the spot and write on them with permanent markers, but they will not dry completely for three to four days. This means they must be taped onto the craft now and/or glued when they are dry. If you use modeling or polymer clay, they will need to be baked dry or air-dried over several days before craft time, but then they can be decorated and glued immediately during class. Roll or press the gray clay into thin pieces measuring 2 x 3 ½ inches.
2. Color Moses and the Israelites. Use scissors or a craft knife to cut along the outlines of Moses’s thumbs. Center the picture on a piece of construction paper or another layer of cardstock and glue it on, except for the area behind the thumbs.
3. Paint the cow-shaped animal cracker metallic gold and, when it is dry, hot glue it onto the pedestal in the picture (with adult assistance). If you use regular glue instead, reinforce it with masking tape until the glue has dried completely.
4. *Optional:* Use a permanent marker to add numbers one through ten to the clay tablets if you wish.
5. Tuck the clay tablets under Moses’s thumbs and hot glue his thumbs in place (or use regular glue and temporary masking tape).
6. *Optional:* Cut out the illustrated verse and glue it to the back of your picture.

**MAKE IT SIMPLE:** Cut around Moses’s thumbs, paint the cows, and create the tablets ahead of time (unless you are using Model Magic®) so that they are completely dry. Give firm directions that students must not lick or eat the cows or the tablets. If necessary, just make the tablets from gray cardstock.

**MAKE IT AMAZING:** Copy the picture twice. Cut Moses out of the first picture, color him, flip him over, and glue strips of foam board in a single layer to the back of his head, arms (not hands), and body. The strips should not show when you flip him around again. Cut the second picture along the top of the hills (through Moses’s fingers) and glue it to a sky-colored backing sheet. Glue the cut-out Moses over the flat Moses. Arrange and glue the clay tablets so that Moses’s thumbs are still on top and the rest of his hands bend down to the level of the lower paper. Paint the pedestal metallic gold as well as the cow-shaped cracker.





"I am the LORD your God. . . . You shall have no other gods before me."  
**EXODUS 20:2-3 ESV**



## GOD SENDS SPIES TO CANAAN

*Numbers 13:1-14:10*

The LORD is with us; do not fear them. (Num. 14:9)

### SUPPLIES:

(to make one craft)

- template of Canaan map (see page 57)
- 1 sheet of cream-colored paper, or a piece of a brown paper bag
- crayons, markers, or paint
- optional:* deckle scissors
- 2 cardboard toilet-paper cylinders
- hot-glue gun
- yarn or curling ribbon
- scissors
- optional:* 1 sheet of copy paper

### INSTRUCTIONS:

**PREP STEP:** Copy the map template onto cream or tan paper. A piece of paper bag will do, but might not work in every photocopier. In that case, place the panel over the map and press it to a sunny window (or light box) so that you can trace the map. *Optional for Step 4:* Copy the illustrated verse.

1. Make your spy map look old and worn: Crumple the map tightly, then unfold it, color or paint it, and tear the edges or cut them with deckle scissors.
2. Use a stripe of hot glue (with adult assistance) to fasten the cardboard cylinders together to form binoculars. If you only have regular glue, let it dry overnight before you continue. Use yarn or curling ribbon to tie the ends of the tubes together. Attach a loop large enough to fit over your head by tying the ends of your loop to one of the end ribbons you just added.
3. Decorate the binoculars with crayons, markers, or paint.
4. *Optional:* Cut out the verse and glue it to your binoculars or map.

**MAKE IT SIMPLE:** Construct the binoculars and cut out the maps before class. If need be, you can skip all the ribbon on the binoculars.

**MAKE IT AMAZING:** Have an adult burn or singe the edges of your map. Cover your cardboard cylinders with Contact™ or other decorative paper, and/or ring the rims with masking tape before gluing the cylinders together.

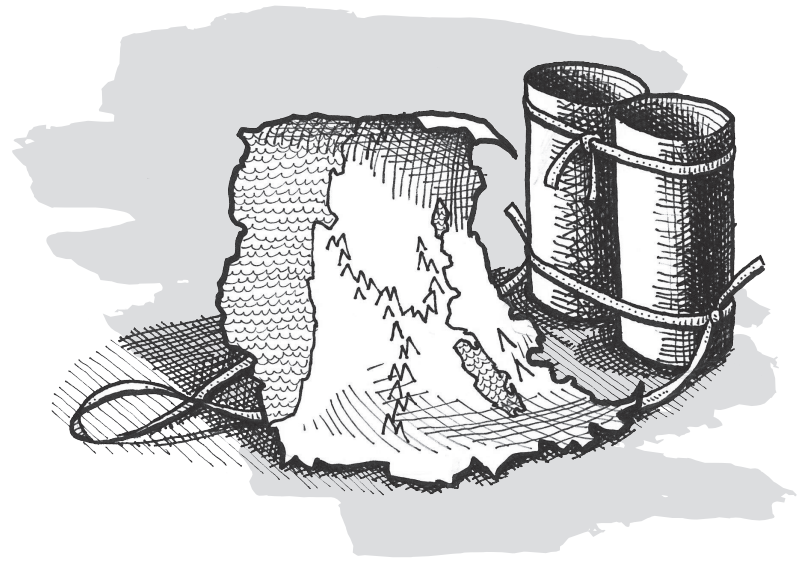



The LORD is with us; do not fear them. NUMBERS 14:9 ESV

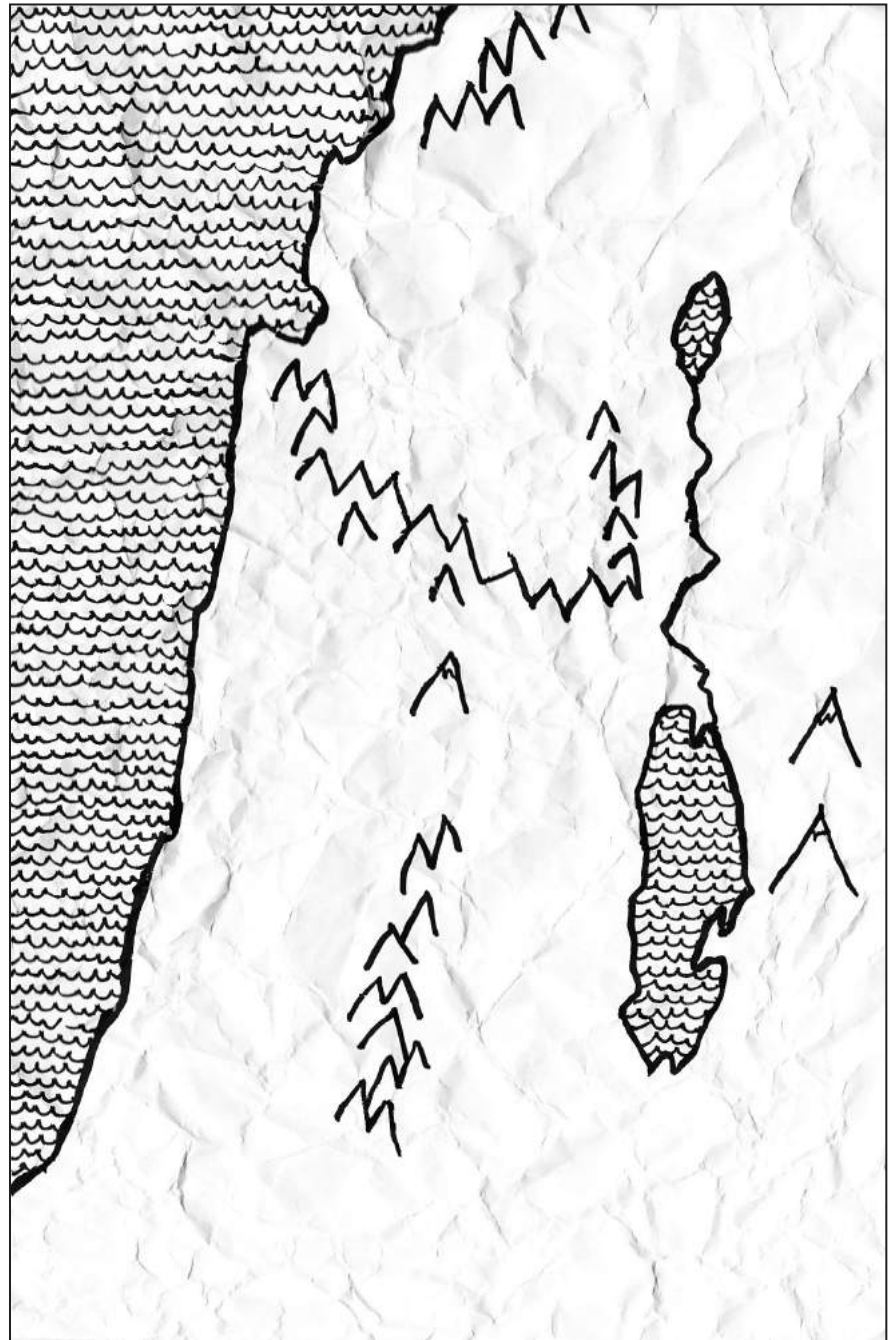

Canaan map template

## GOD PROVIDES WATER FROM A ROCK

*Exodus 17:1-7; Numbers 20:2-13*

Do not harden your hearts, as at Meribah. (Ps. 95:8)

### SUPPLIES:

(to make one craft)

- 1 sheet of white copy paper
- template of Moses (below)
- crayons or markers
- scissors
- a clean, smooth rock of reasonable size
- glue
- blue glitter glue or light-blue tempera paint
- paintbrush

### INSTRUCTIONS:

**PREP STEP:** Copy the Moses template, enlarging or reducing the template as needed to fit your rock.

1. Color and cut out Moses. Glue him onto your rock, making sure that his staff does not go off the edge.
2. Paint “water” streaming down the rock from the tip of the staff.
3. *Optional:* Cut out the illustrated verse and glue it to the back of the rock.

**MAKE IT SIMPLE:** Cut out Moses before class, and provide a smooth 3- to 4-inch stone for each student. Set up a supervised painting station away from the coloring and gluing table, and have one or two students paint at a time.

**MAKE IT AMAZING:** Glue a stick or twig in place of Moses’s staff. Consider finishing your project by spraying or painting on a coat of clear sealer/finisher such as Mod Podge™ or Krylon™.

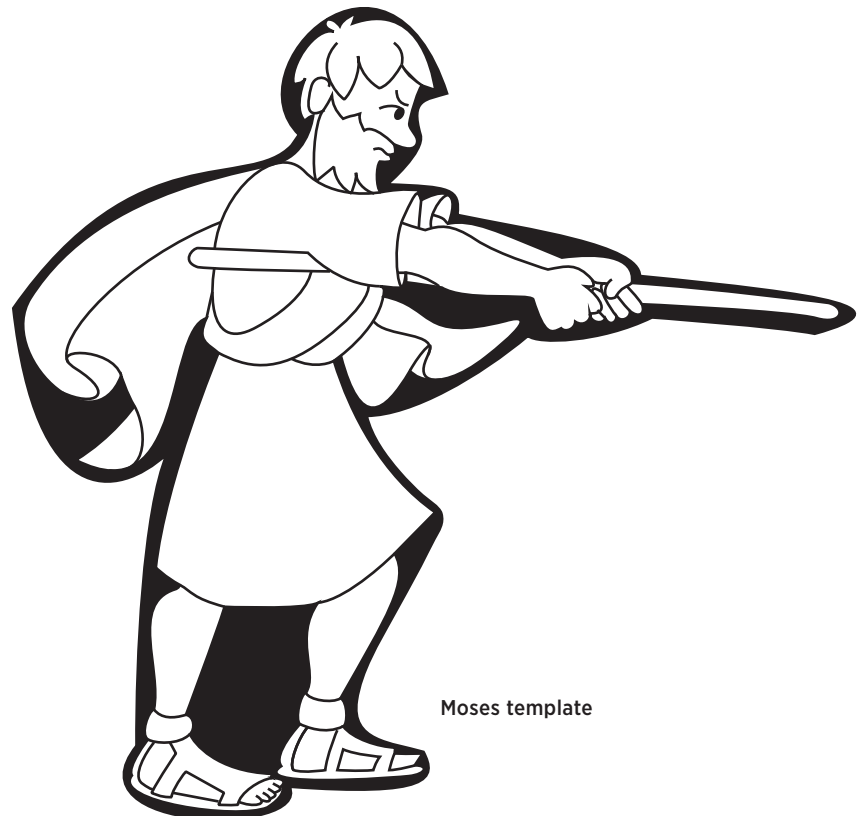
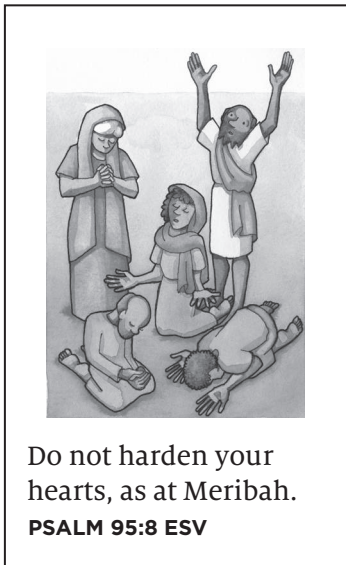

Moses template

# GOD MAKES A DONKEY SPEAK

*Numbers 22-24*

I know that you can do all things, and that no purpose of yours can be thwarted. (Job 42:2)

## SUPPLIES:

(to make one craft)

- 1 paper grocery bag
- 1 paper lunch sack
- templates of donkey head and ears (see pages 60-61)
- 2-3 sheets of copy paper
- pen or pencil
- scissors
- glue
- stapler
- crayons or markers
- black yarn or black construction paper

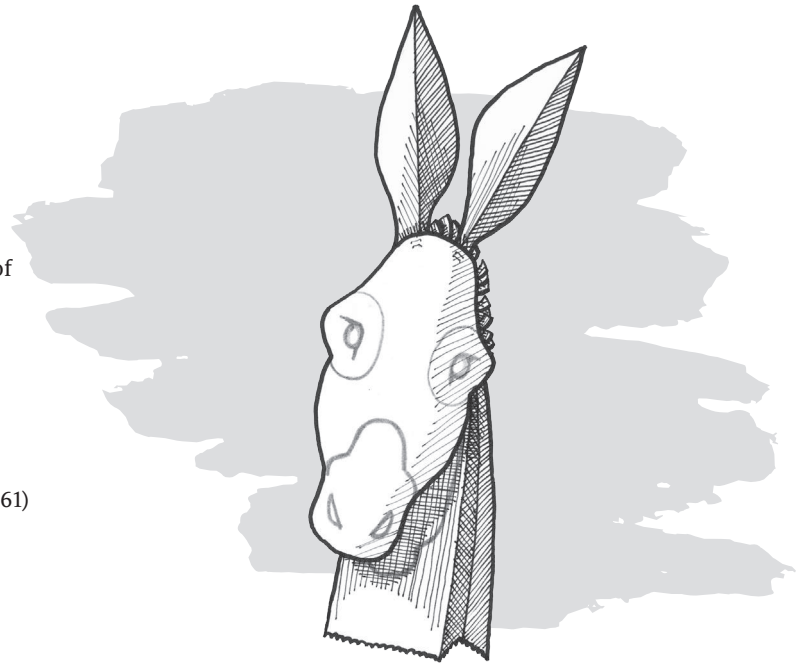

## INSTRUCTIONS:

**PREP STEP:** Copy the donkey head and ears templates onto paper and cut them out to use as a pattern. *Optional for Step 6:* Copy the illustrated verse.

1. Trace around the cut-out templates onto an area of paper grocery bag that is free of print. Cut the three pieces out.
2. Glue the bottom of the lunch bag onto the back side of the donkey head as shown.

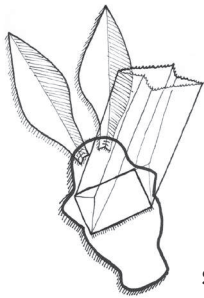

Steps 2 and 3

3. Fold the ears sharply lengthwise, then open and staple them to the head as shown.
4. Use crayons or markers to draw the face on the donkey, including a lower jaw on the bag itself. (If you wish, you can cut apart the head template to trace around its sections.)
5. When you are done coloring the face and mouth, add a mane down the center of the back. Either glue on pieces of yarn or cut fringe into a 1 x 1 ½-inch-wide strip of black construction paper. Leave a long edge unfringed in order to glue it to the bag.



Step 5

6. *Optional:* Cut out the illustrated verse and glue it to the donkey's neck.

**MAKE IT SIMPLE:** Cut out the heads and ears before class. Draw the outlines of faces and jaws for the students to color. The donkey's mane can be drawn on with black markers if time is short.



I know that you can do all things, and that no purpose of yours can be thwarted.

**JOB 42:2 ESV**

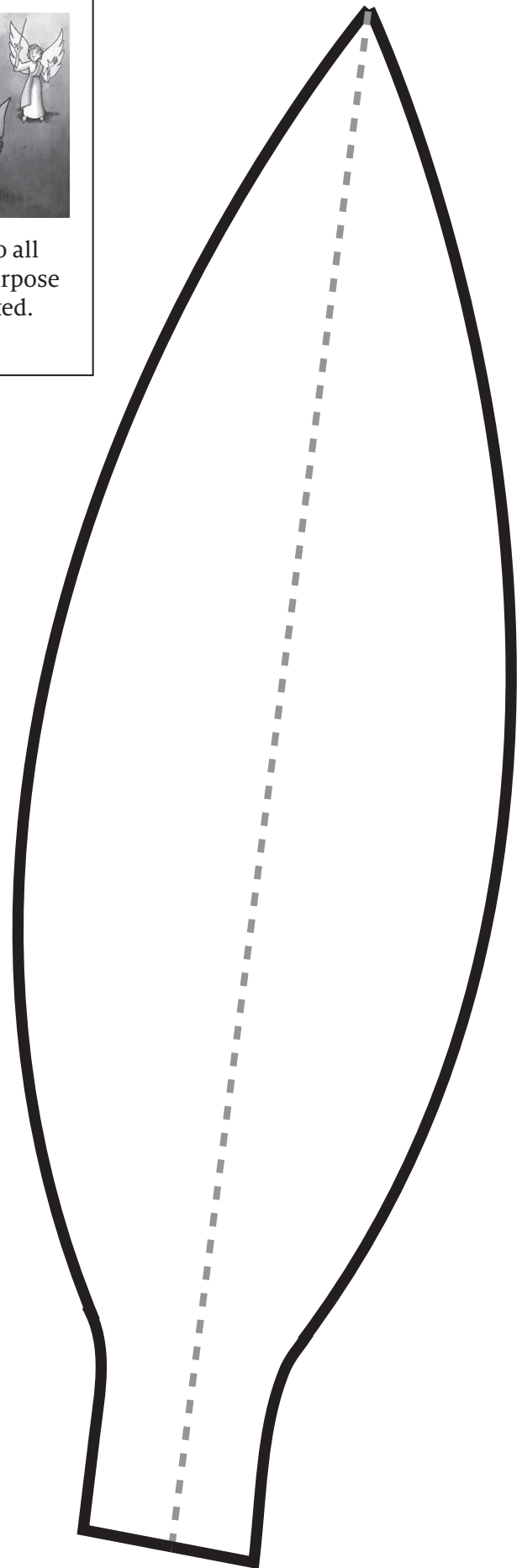
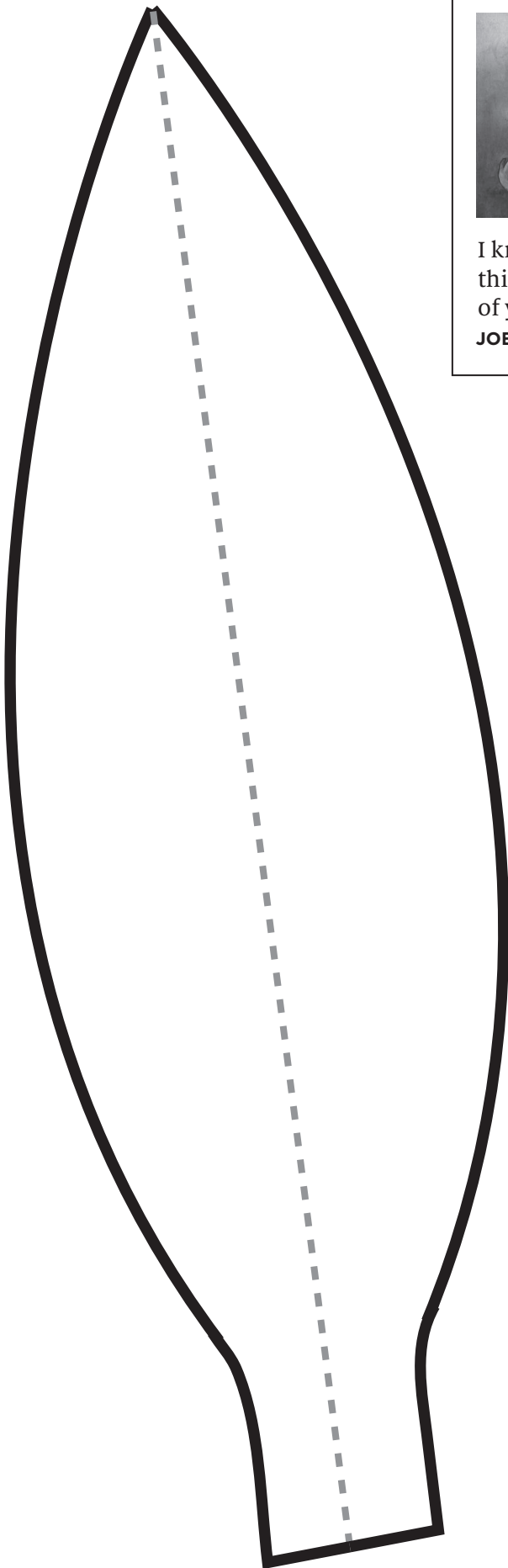

donkey ears template



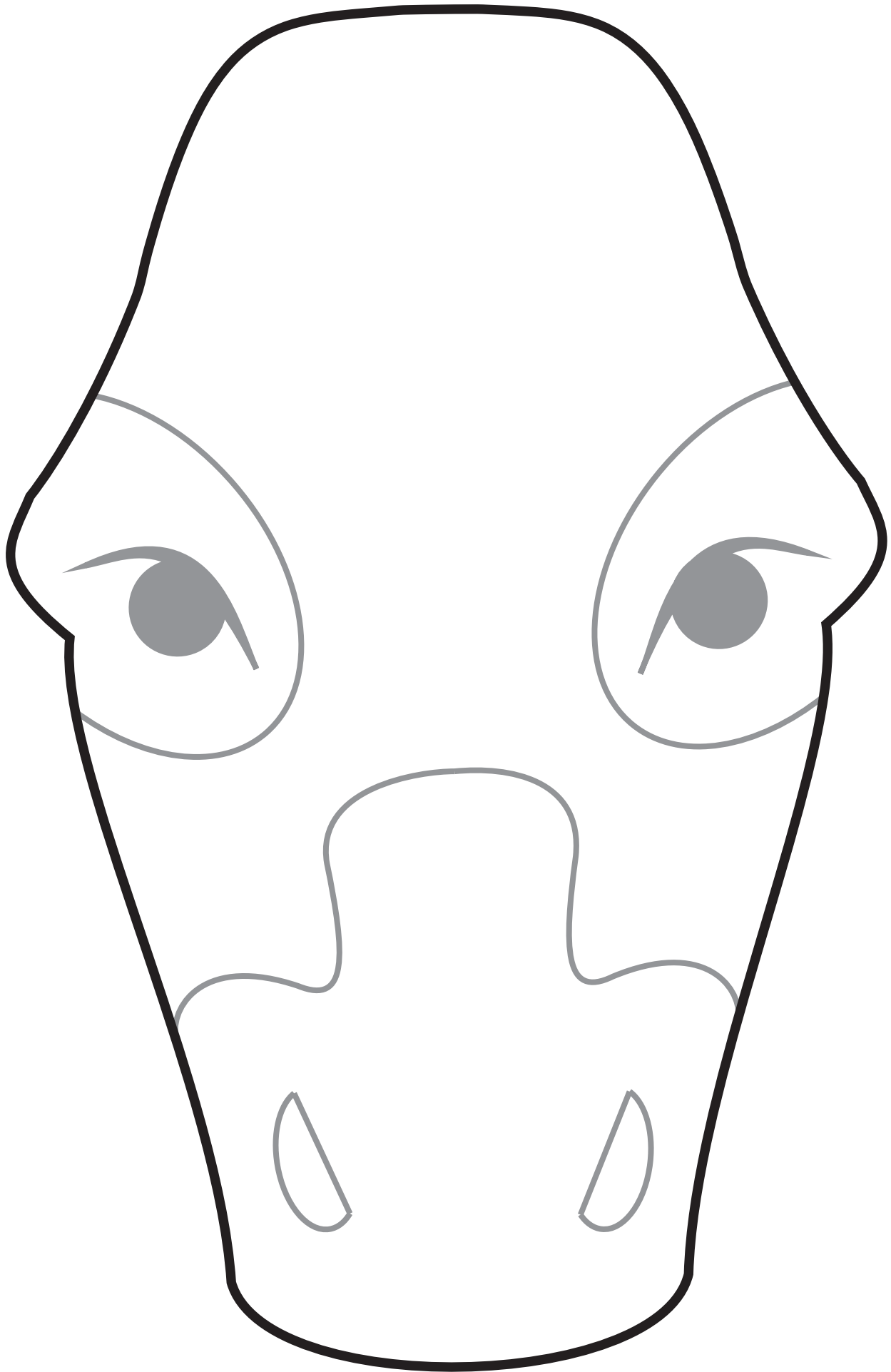

## GOD HEALS WITH A BRONZE SNAKE

*Numbers 21:4-9*

As Moses lifted up the serpent in the wilderness, so must the Son of Man be lifted up, that whoever believes in him may have eternal life. (John 3:14-15)

### SUPPLIES:

(to make one craft)

- 2 wide popsicle sticks
- hot-glue gun, regular glue, or tape
- crayons or markers
- 1 sheet of metallic-gold or bronze paper
- template of snake (see below)
- optional*: 1 sheet of copy paper

### INSTRUCTIONS:

**PREP STEP:** Copy the snake template onto the back of a piece of metallic paper (or copy it onto regular paper and then trace it onto the metallic paper). *Optional for Step 2:* Copy the verse.

1. Fasten the sticks to form a cross (hot glue works well with popsicle sticks). Decorate the cross with crayons or markers.
2. *Optional:* Cut out the verse and glue it to the back of the cross.
3. Cut the snake from the metallic paper. Decorate it if you wish.
4. Arrange the snake on the sticks, fastening it in place with glue or tape when you are satisfied.

**MAKE IT SIMPLE:** Use hot glue to connect the sticks before class and cut out all the snakes.

As Moses lifted up the serpent in the wilderness, so must the Son of Man be lifted up, that whoever believes in him may have eternal life. **JOHN 3:14-15 ESV**

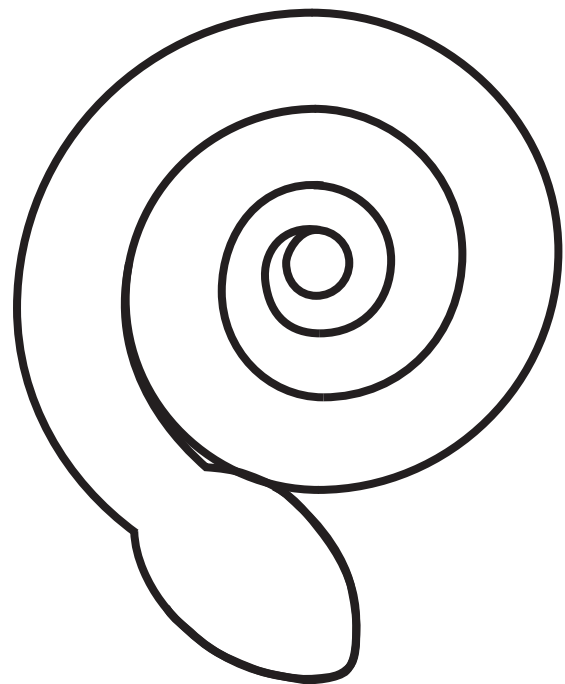
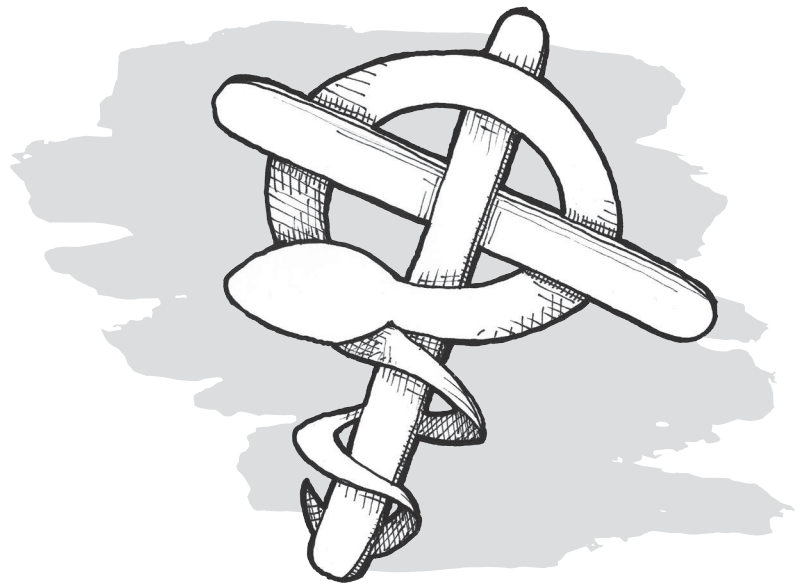

snake template

## GOD PROTECTS RAHAB'S FAMILY AND GIVES HIS PEOPLE VICTORY OVER JERICO

*Joshua 2-4, 5:10-6:27*

By faith the walls of Jericho fell. . . . By faith Rahab . . . [gave] a friendly welcome to the spies. (Heb. 11:30-31)

### SUPPLIES:

(to make one craft)

- 2 sheets of white, gray, or tan cardstock
- templates of the wall and of Jericho (the full pages) (see pages 64-65)
- pencil
- crayons or markers
- scissors
- tape
- glue
- optional*: craft knife such as X-Acto™
- scarlet red ribbon or yarn
- optional*: 1 sheet of copy paper

### INSTRUCTIONS:

**PREP STEP:** Copy the full-page template of Jericho onto white or tan cardstock. Copy the template of the wall onto gray, tan, or white cardstock. *Optional for Step 6:* Copy the illustrated verse.

1. Use a pencil or marker to fill Jericho with people and soldiers. Color the city and people.
2. Cut out the big rectangle that borders the wall image. Draw the Israelites marching around the base of the upright wall with trumpets and the ark. Color the people, the wall, and the rubble.
3. Fold the wall panel in half on the dotted line so that one side shows rubble and the other side shows the upright wall and Israelites, then paste or tape the panel closed. Use scissors or an X-Acto™ knife (with an adult) to slit the bold line along the edge of the last window in the wall. Thread a scarlet red ribbon or yarn through the slit and secure it with tape on the rubble side of the wall. Cut out the final section (Rahab's home) from the rest of the wall along the solid line.
4. Place the entire wall (including Rahab's section) in front of Jericho, and run a strip of tape along the bottom edge to form a hinge. Run tape up the right side of the wall as well, to keep Rahab's section standing, or else paste it in place.
5. Swing the larger section of the wall down on its tape hinge to reveal the rubble, slitting the tape at either end as necessary to allow it to swing freely. Reinforce the hinge by placing a strip of tape on the rubble side as well, but don't allow the tape to extend past the edges of the swinging panel.
6. *Optional:* Cut out the illustrated verse and paste it to your craft.

**MAKE IT SIMPLE:** Cut, crease, slit, and paste the wall panels closed before class. If necessary, just draw the scarlet cords with markers.

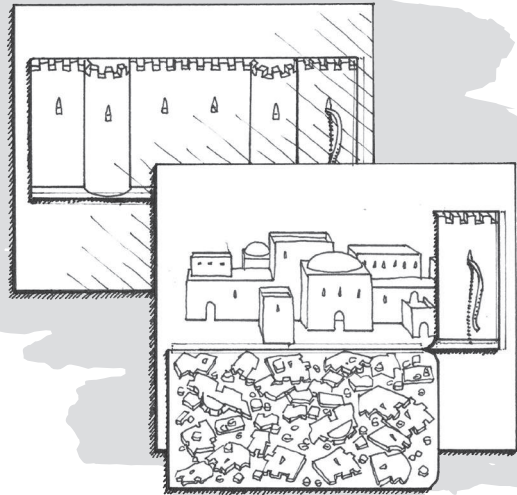

By faith the walls of Jericho fell. . . . By faith Rahab . . . [gave] a friendly welcome to the spies. **HEBREWS 11:30-31 ESV**

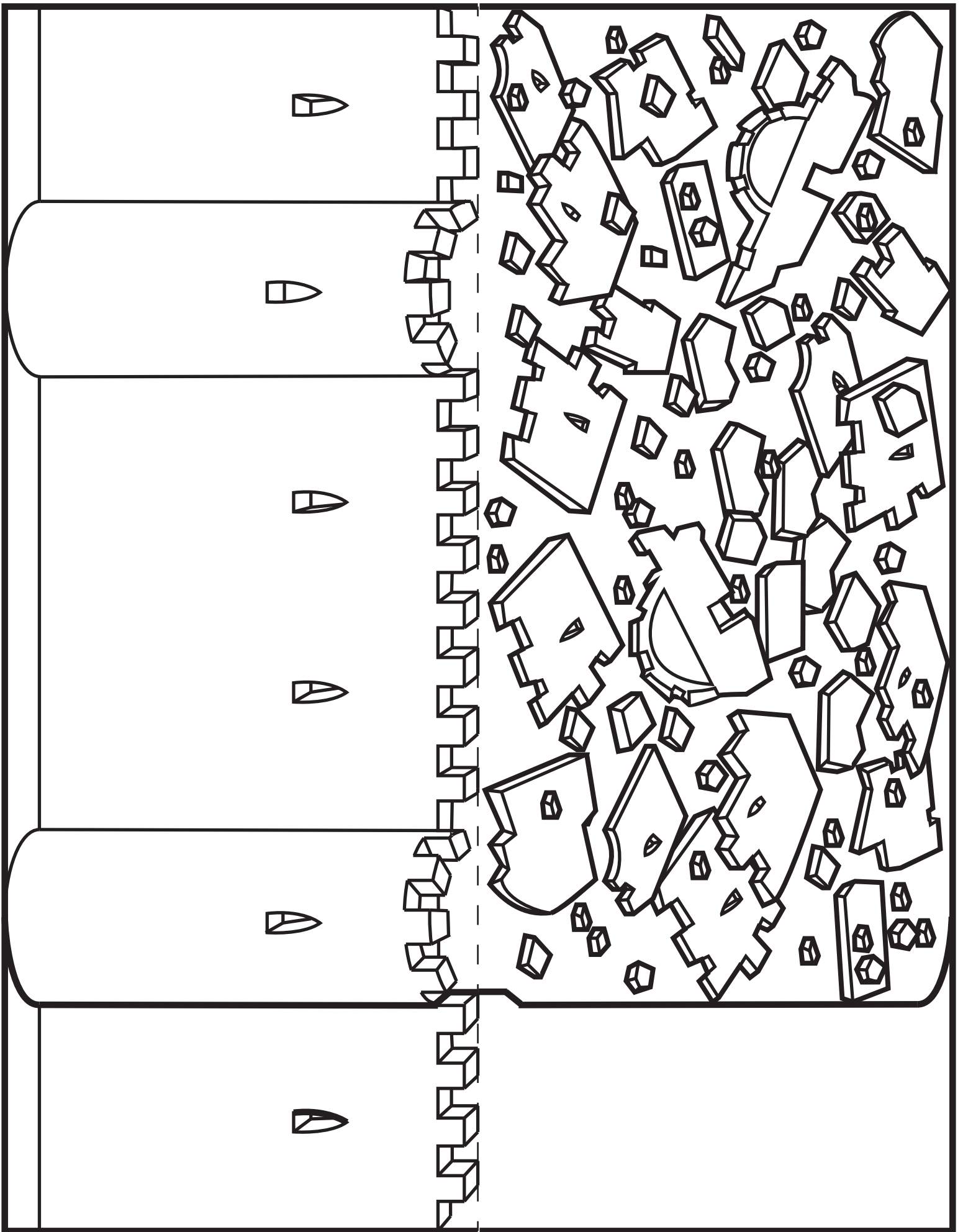

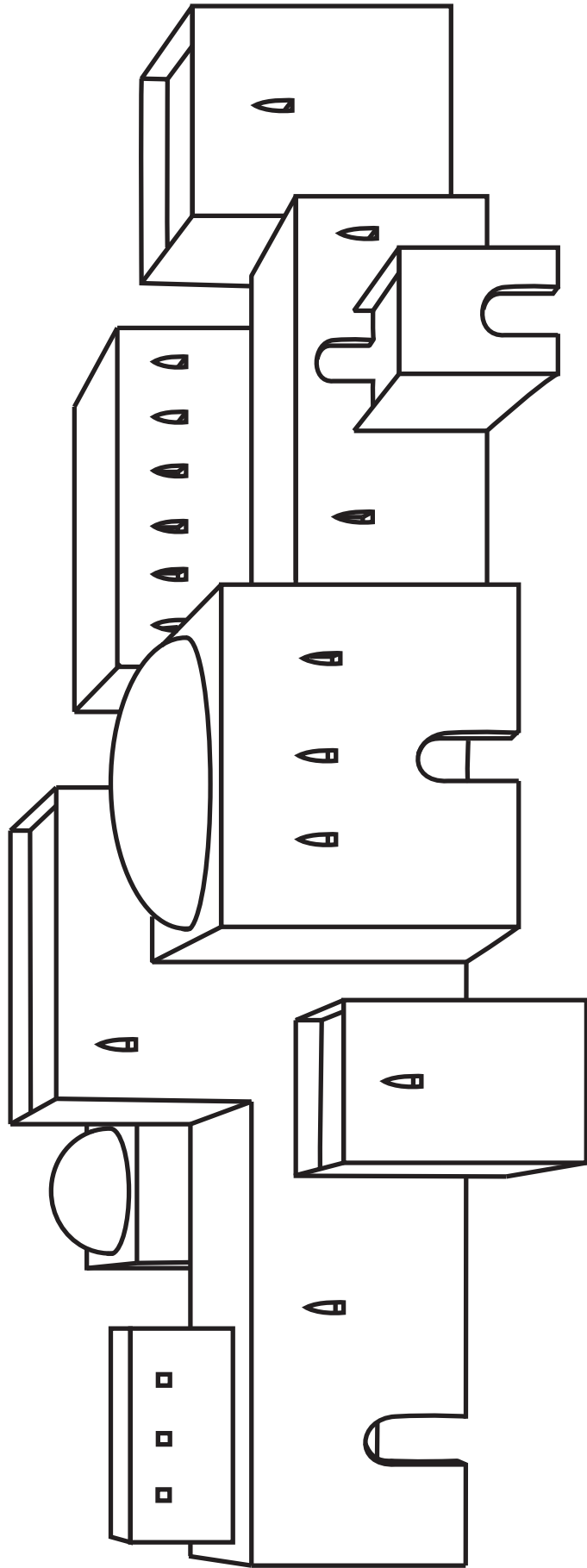



## ACHAN DISOBEYS

Joshua 7

Be sure your sin will find you out. (Num. 32:23)

### SUPPLIES:

(to make one craft)

- 1–2 sheets of any colored copy paper (same or different colors)
- templates of Achan's tent, cloak, shekels, and bar of gold (see page 67)
- crayons or markers
- scissors
- glue or double-sided tape
- 1 sheet of tan or brown cardstock or paper
- optional: silver- and gold-metallic papers or craft foam
- optional: 1–2 sheets of copy paper

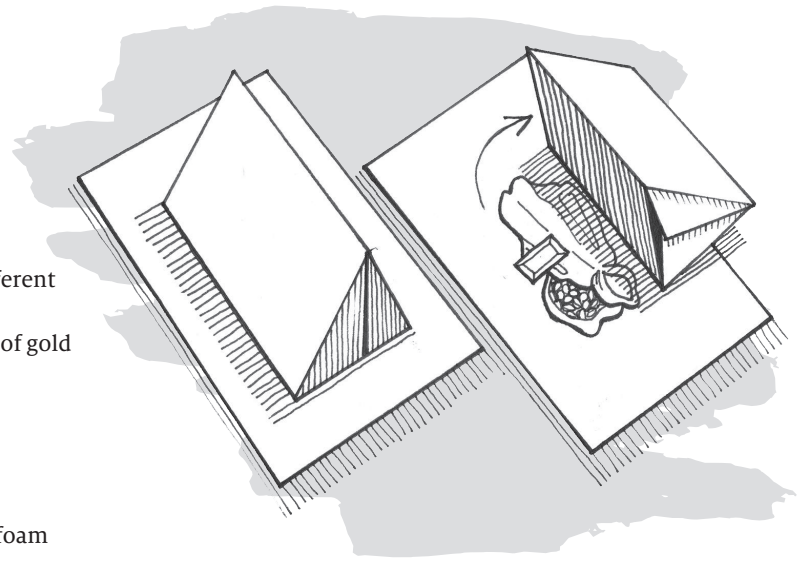

### INSTRUCTIONS:

**PREP STEP:** Copy the template of the tent onto any color paper. Copy the cloak template onto white or colored paper. Copy the silver shekels and gold-bar template onto silver- and gold-metallic paper (or copy them onto white paper, see **Step 3**). *Optional for Step 4:* Copy the illustrated verse.

1. Color the tent if you wish and cut it out. Flip it face down and fold inward on all the dotted lines. Apply glue or double-sided tape to the gray areas and fasten the tent together.

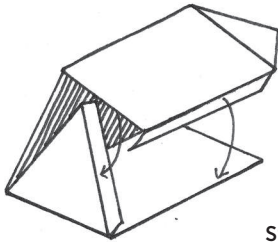

Step 1

2. Cut a sheet of tan or brown cardstock in half crosswise, or fold a piece of tan or brown paper in half crosswise, and glue it shut. Place Achan's tent where you want it on the tan or brown paper and attach it with a single piece of tape the same length as the tent. Create a hinge with the tape so that the tent can be tilted to one side to reveal what is beneath it.
3. Color the cloak and cut it out. Cut out the silver shekels and gold bar (if you copied them onto metallic paper), or color them silver and gold before cutting them out (if you copied them onto white paper). Another option is to cut circle "coins" and a rectangle from silver and gold craft foam or other material. Arrange the items under the tent so that they are only visible when the tent is tilted up.
4. *Optional:* Cut out the illustrated verse and paste it to the craft.

**MAKE IT SIMPLE:** Cut out and crease the tents ahead of time. Also, cut out the stolen items beforehand.

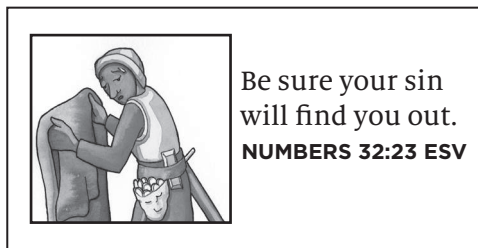

Be sure your sin  
will find you out.  
**NUMBERS 32:23 ESV**

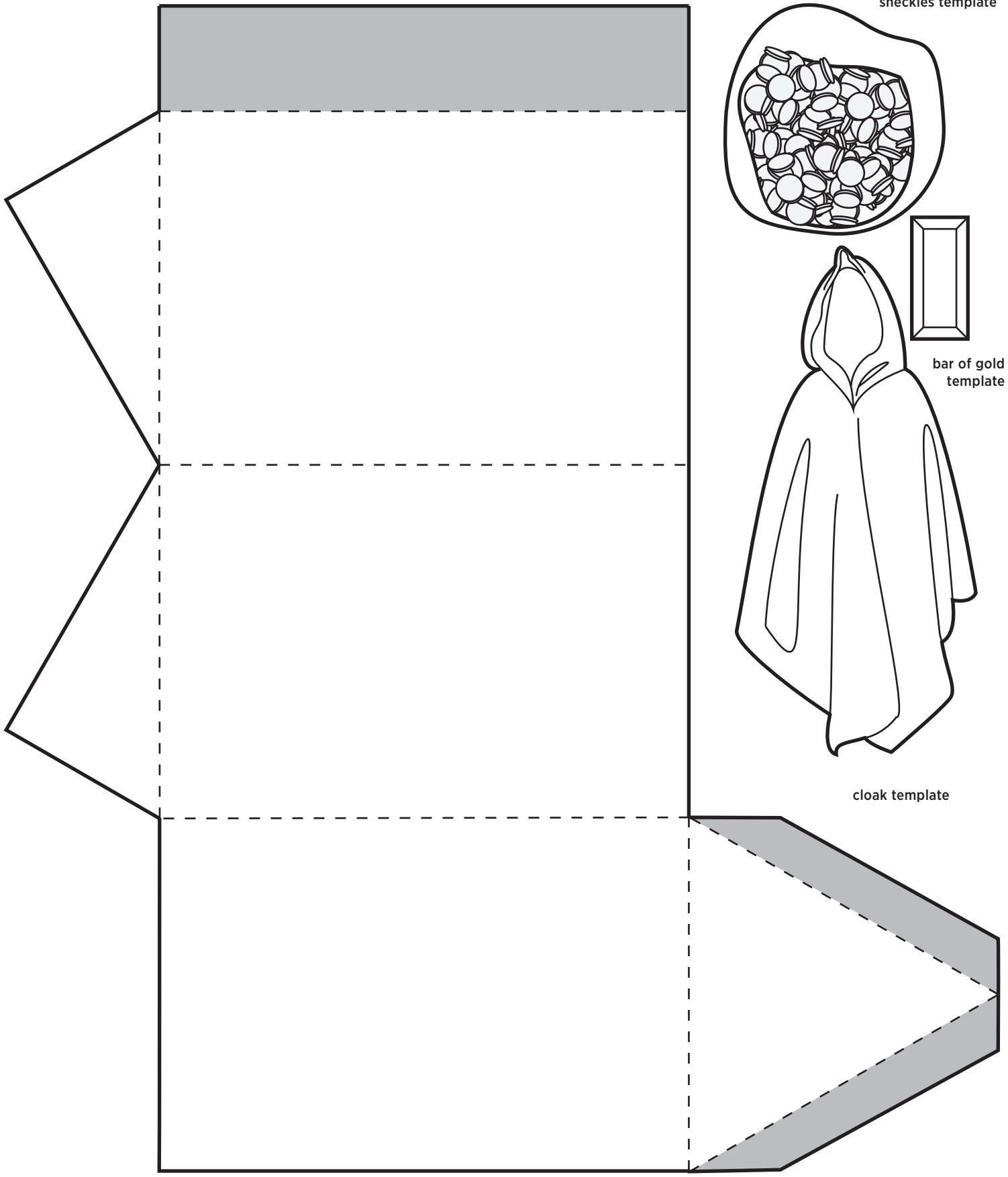

Achan's tent template

sheckles template

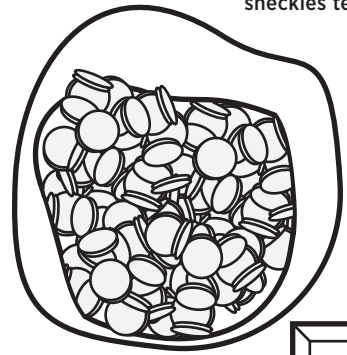

bar of gold template

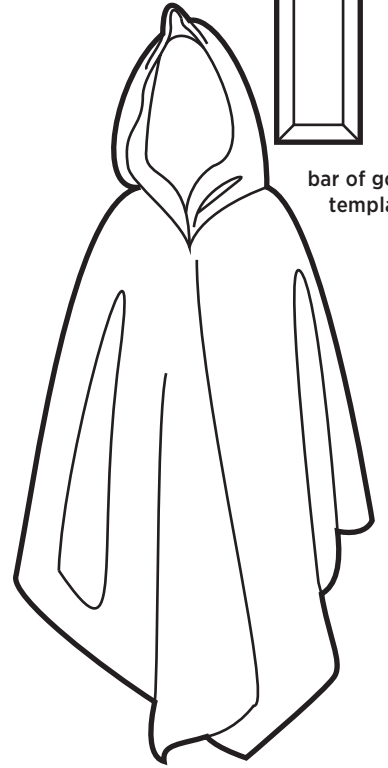

cloak template

# GOD SAVES ISRAEL THROUGH GIDEON

*Judges 6:11-7:23*

The LORD your God is he who goes with you to fight for you against your enemies, to give you the victory.

(Deut. 20:4)

## SUPPLIES:

(to make one craft)

- 1 sheet of brown, black, or white cardstock or paper
- tape
- crayons or markers
- two 10-inch squares of yellow or orange tissue paper
- glue
- 1 empty food-packaging cylinder such as an oatmeal, coffee, or ice cream container
- optional:* additional colored paper
- 1 sheet of white copy paper
- template of the battle with the Midianites (see page 69)
- scissors

## INSTRUCTIONS:

**PREP STEP:** Copy the battle scene template onto white paper.

1. Fold a sheet of brown, black, or white cardstock (or two sheets of paper) in half crosswise and crease. Roll one corner up at an angle as shown and continue rolling until the paper is a narrow cone. Tape the end in place and decorate this cone-shaped torch handle with crayons or markers if you wish.

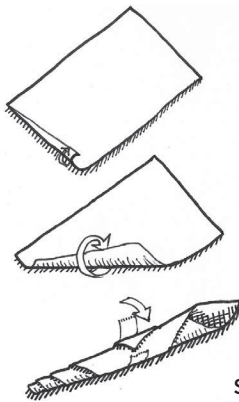

Step 1

2. Take two 10-inch squares of yellow or orange tissue-paper and poke their centers into the top of the handle so that the eight tissue paper corners spread up and out like flames. Glue or tape the centers in place just inside the handle. Your torch is now "lit."
3. Use your food container as a "jar" to temporarily hide your torch's flame. If you wish, wrap colored paper around your jar and glue or tape it in place. Color Gideon's battle scene, cut it out, and glue it onto the jar as well.

**MAKE IT SIMPLE:** If you need "jars" for many students with little notice, just make paper cylinders from 12 x 18-inch sheets of doubled-up construction paper fastened with packing tape or staples. Have battle scenes ready to color, tissue squares cut to size, and torch handles assembled before class.

**MAKE IT AMAZING:** Make a "trumpet" to go with your torch and jar: Roll a full sheet of cardstock diagonally as you did the torch handle, creating a longer, narrow cone. After taping it in place, tie on a curling ribbon loop long enough to allow you to take the trumpet on and off over your head. Tape the ribbon in place so the trumpet does not slip out.

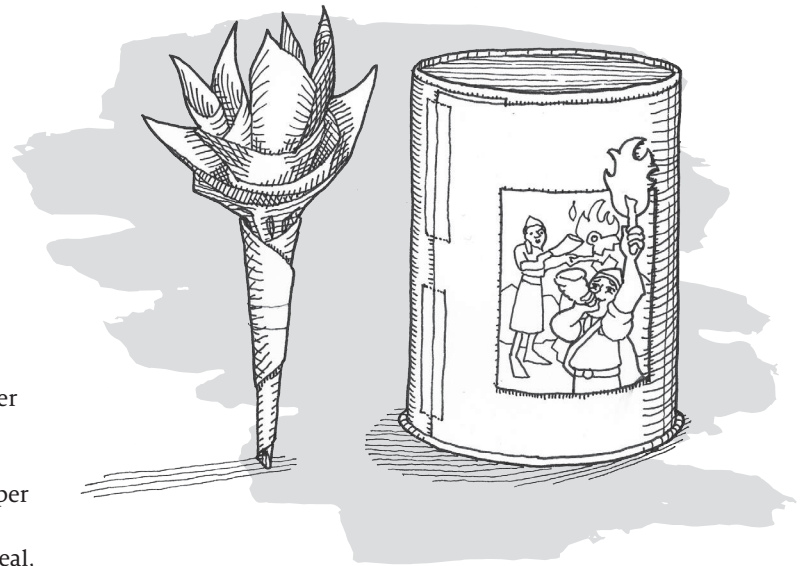

The LORD your God is he who goes with you to fight for you against your enemies, to give you the victory. **DEUTERONOMY 20:4 ESV**



battle with Midianites template

# GOD JUDGES THE PHILISTINES THROUGH SAMSON

*Judges 13-16*

The LORD raised up judges, who saved them out of the hand of those who plundered them. (Judg. 2:16)

## SUPPLIES:

(to make one craft)

- 1 sheet of white cardstock or paper
- template of Samson (the full page) (see page 72)
- crayons or markers
- scissors
- tape
- optional: glue
- optional: 1 sheet of copy paper

## INSTRUCTIONS:

**PREP STEP:** Copy the full-page template of Samson onto white cardstock. *Optional for Step 5:* Copy the illustrated verse.

1. Color Samson.
2. Cut on the solid lines to remove the squares from the upper corners of the page. Set them aside for later. Cut both sides of the remaining horizontal line on its solid ends only. Fold the remaining top flap (which will become the ceiling) down on the dotted line, crease it, and unfold it.
3. Create pillars on either side of Samson: Place a long strip of tape sticky-side down on the left vertical edge of the page, but do not let the tape adhere to your table. Rotate your picture so that the edge with the tape is the furthest edge from you, pinch its corners with two hands, and roll the paper back toward you. Allow the paper to make only one full roll completed at the point where it meets Samson's hand. The strip of tape will now be facing down toward the picture surface, so press it there, slipping a finger in either end of the cylinder to secure the tape and close the pillar. Repeat this process on the right side of the page to create the second pillar.
4. Fold the ceiling tab back down 90 degrees to form the roof, and secure its underside to the top of one or both pillars with tape if you wish. Take the squares you previously set aside and set them under the pillars to form their bases. Fasten them in place with tape and/or glue.
5. *Optional:* Cut out the illustrated verse and glue it to the back of the structure.

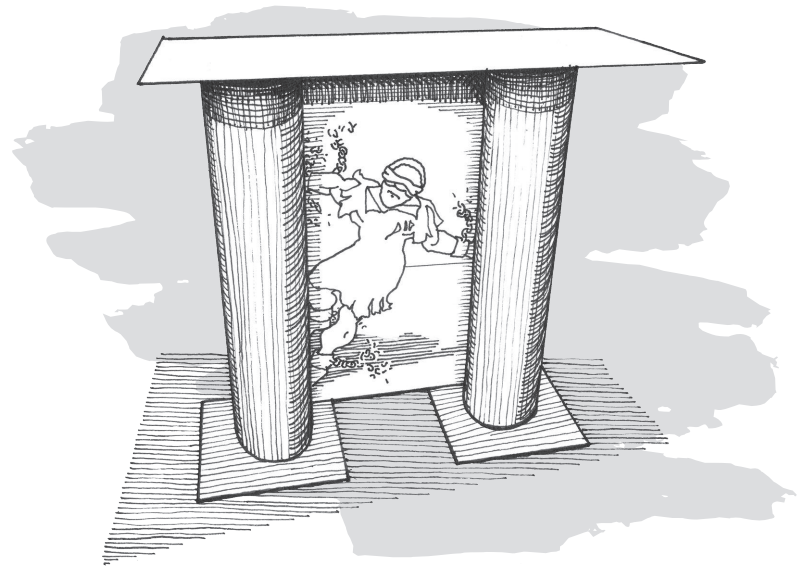
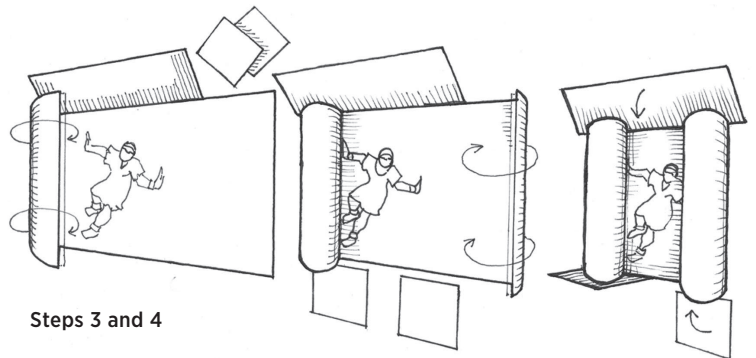

**MAKE IT SIMPLE:** Rolling the pillars requires some finesse, so do this ahead of class. Students can tape the roofs and bases on after they have colored them.

**MAKE IT AMAZING:** Draw the faces of jeering, Dagon-worshiping Philistines in the gray area behind Samson. Draw cracks beginning to form on the pillars.





The LORD raised up judges,  
who saved them out of the  
hand of those who plundered  
them. **JUDGES 2:16 ESV**

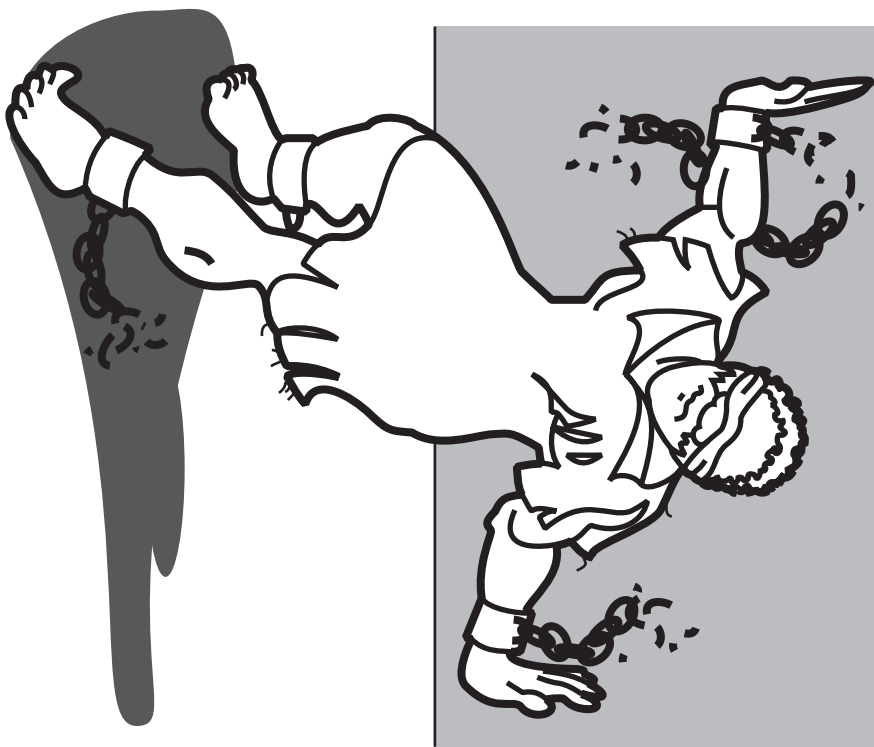

## GOD PROVIDES A FAMILY FOR RUTH

Ruth 1-4

Blessed be the LORD, who has not left you this day without a redeemer! (Ruth 4:14)

### SUPPLIES:

(to make one craft)

- 1 sheet of white paper
- template of harvesters and gleaners taking a break (see page 74)
- crayons or markers
- Optional:* 1 sheet of copy paper

### INSTRUCTIONS:

**PREP STEP:** Copy the harvesters and gleaners template onto white paper. *Optional for Step 3:* Copy the illustrated verse.

1. Color the harvesters and gleaners.
2. Bring Boaz and Ruth together in marriage: Fold Boaz back behind the scene, creasing on the dotted line next to him. Then bring that crease over to Ruth by folding inward on the remaining dotted line.

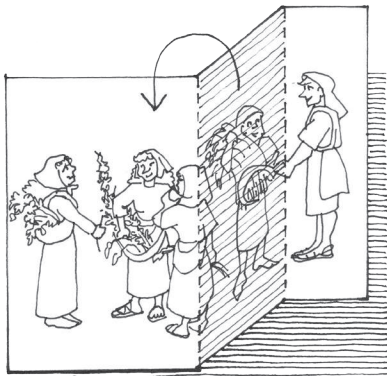

Step 2

3. *Optional:* Cut out the illustrated verse and paste it to the picture.

**MAKE IT SIMPLE:** Crease folds before class.

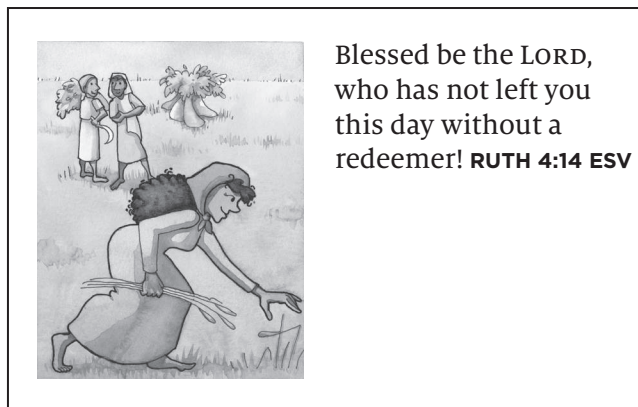

Blessed be the LORD,  
who has not left you  
this day without a  
redeemer! **RUTH 4:14 ESV**





## GOD PROVIDES A SON FOR HANNAH

1 Samuel 1:1-2:11

Is anyone among you suffering? Let him pray. Is anyone cheerful? Let him sing praise. (James 5:13)

### SUPPLIES:

(to make one craft)

- 1 sheet of white cardstock
- templates of Hannah and praying hands (see page 76)
- crayons or markers
- scissors
- glue

### INSTRUCTIONS:

**PREP STEP:** Copy the templates of Hannah and her hands onto white cardstock.

1. Color Hannah and her hands and cut them out.
2. Fold Hannah's side flaps inward so that their edges meet in the center. Paste Hannah's left and right praying arms onto the back sides of these flaps so that it looks like Hannah is praying when the flaps are closed. When the flaps are open, Hannah is holding baby Samuel.
3. *Optional:* Cut out the illustrated verse and paste it to Hannah's back.

**MAKE IT SIMPLE:** Cut and fold ahead of time.

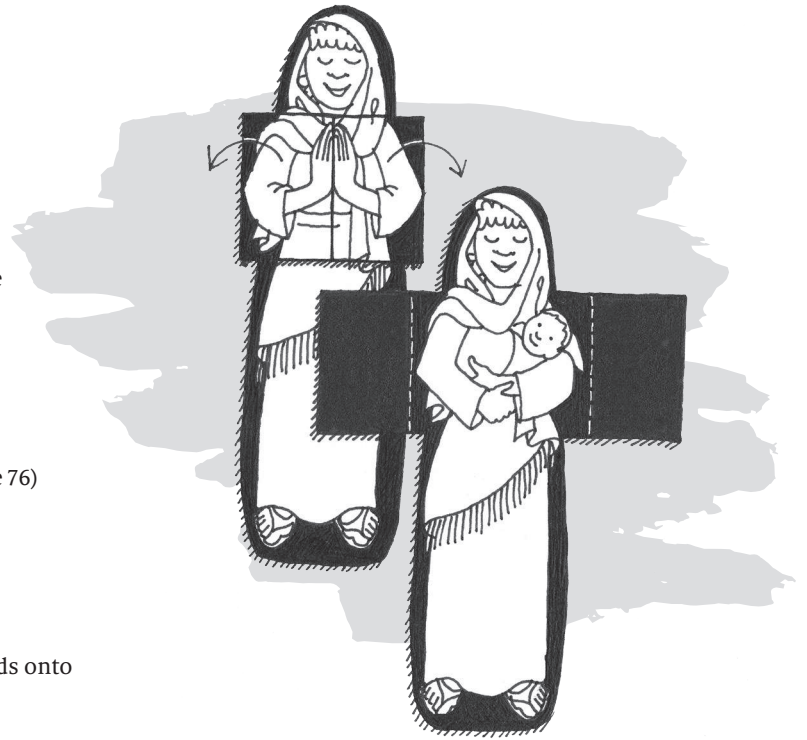



Hannah template

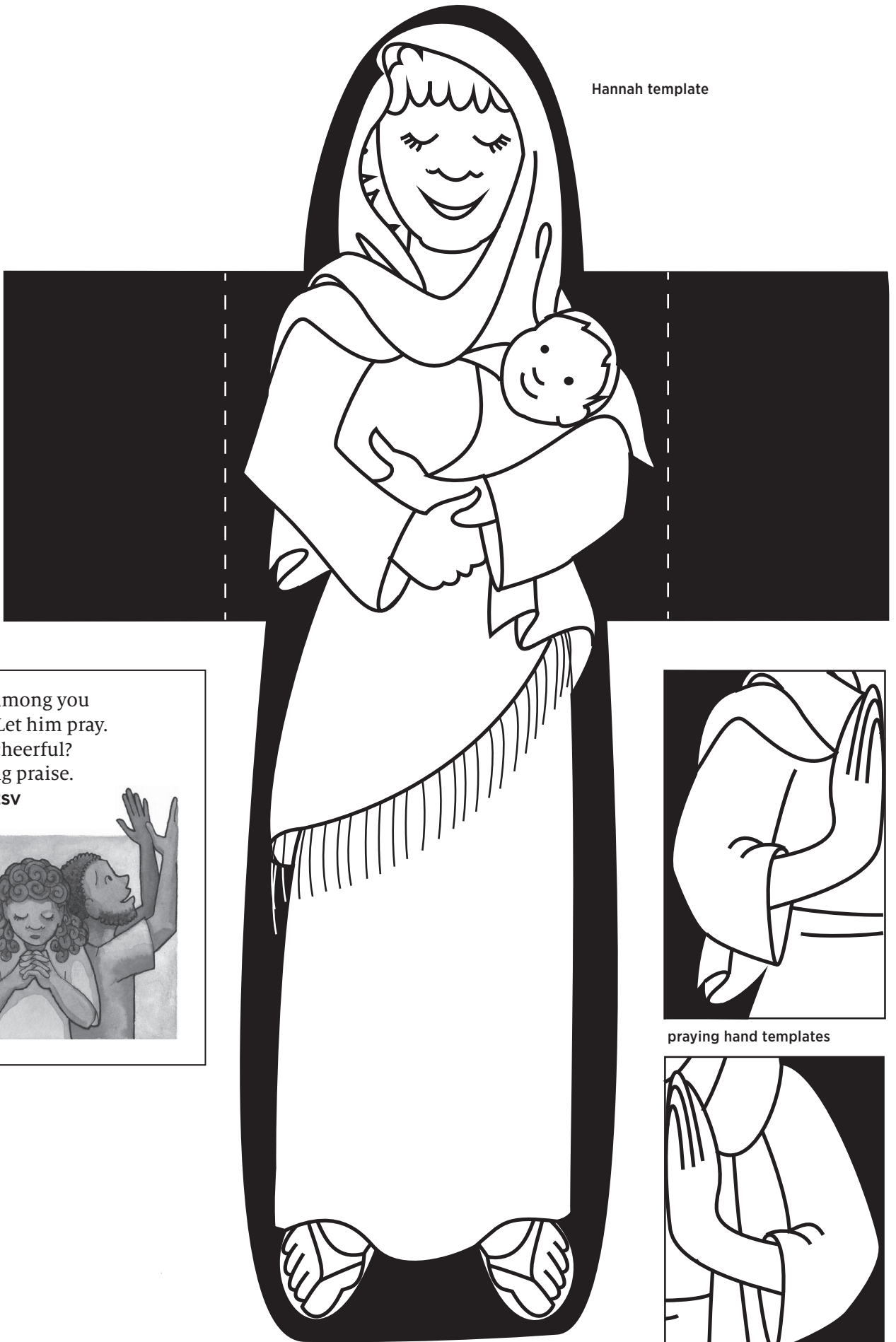

Is anyone among you suffering? Let him pray.  
Is anyone cheerful? Let him sing praise.

**JAMES 5:13 ESV**

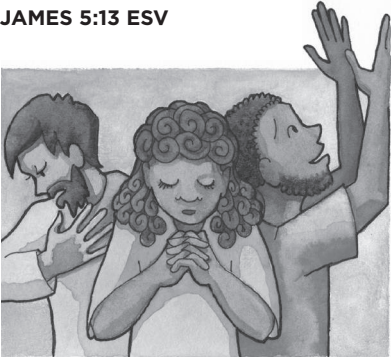

praying hand templates



## GOD CALLS SAMUEL

### 1 Samuel 3

Listen to the words of the LORD your God. (Josh. 3:9)

#### SUPPLIES:

(to make one craft)

- 2 different colored sheets of construction paper
- scrap fabric or additional construction paper
- scissors
- templates of young Samuel and his speech bubble (see page 78)
- 1 sheet of white cardstock
- crayons or markers
- half sheet of blue or black paper
- glue

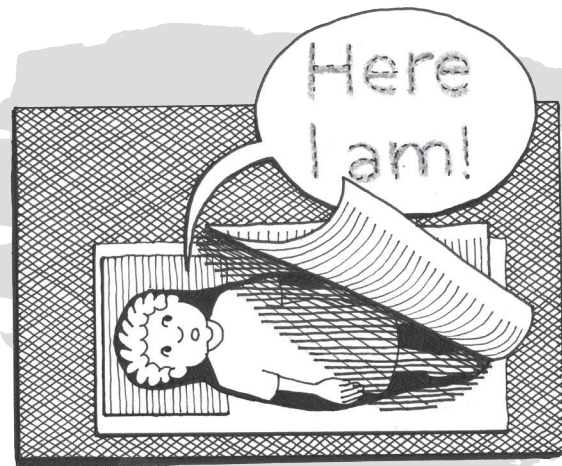

#### INSTRUCTIONS:

**PREP STEP:** Copy the Samuel and speech-bubble templates onto white cardstock.

1. Cut a 6 ½ x 3-inch rectangle from colored paper to make a sleeping mat, a 2 ½ x 2-inch rectangle from paper of another color to make a pillow, and a 4 ½ x 3 ½-inch rectangle from a scrap of cloth or still another color of paper to make a blanket.
2. Color Samuel and cut him and the speech bubble out. Trace the letters in the speech bubble to write “Here I am!”
3. Arranging your half sheet of dark paper horizontally, paste the sleeping mat near the bottom of the page. Paste the pillow to the left end of the sleeping mat. Paste Samuel onto the mat with his head on the pillow, or just lay him there temporarily so that he can easily be taken in and out. Place the blanket over Samuel’s body (but not his face) and glue down only one edge. This way you can pull the blanket back later to see (or place) Samuel underneath. Arrange the speech bubble so that it originates near Samuel’s mouth and extends above the edge of the paper. Fasten it in place, being sure not to put glue on the top half of the bubble.
4. *Optional:* Cut out the illustrated verse and paste it to the back of your picture.

**MAKE IT SIMPLE:** Use a paper cutter to quickly measure and cut multiple rectangles. Copy and cut out Samuel and the speech bubbles ahead of time.

**MAKE IT AMAZING:** Cut the mat and pillow from fabric as well. Make the pillow from two pieces of fabric with a bit of cotton stuffing inside. Use oil pastels to draw the ark of the covenant and the lampstand nearby.



young Samuel template

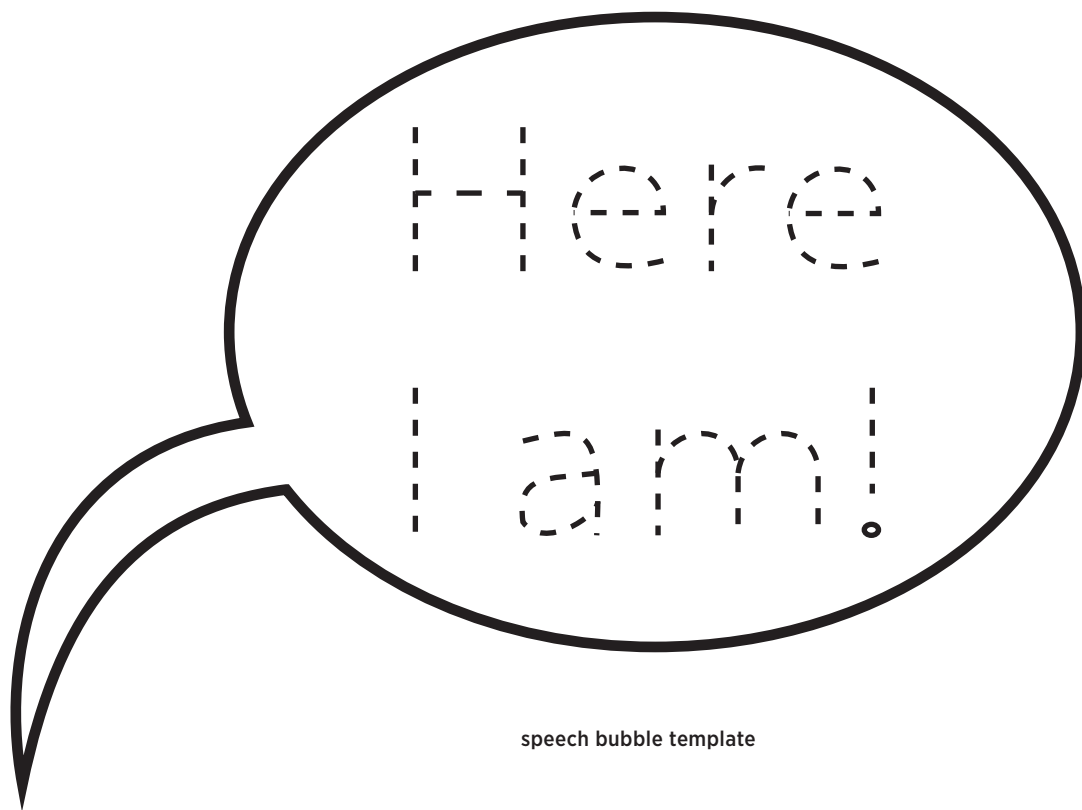

speech bubble template



Listen to the words  
of the LORD your God.  
**JOSHUA 3:9 ESV**

## GOD IS GREATER THAN A FAKE GOD

1 Samuel 4:10–11; 5

All worshipers of images are put to shame. (Ps. 97:7)

### SUPPLIES:

(to make one craft)

- 1 sheet of white cardstock
- templates of ark pieces, its contents and idol (see pages 80–81)
- crayons or markers
- scissors
- glue
- optional: 1 sheet of metallic-gold or yellow cardstock
- 2 drinking straws, preferably yellow or 2 sheets of yellow paper tightly rolled lengthwise
- tape

### INSTRUCTIONS:

**PREP STEP:** Copy the templates of Dagon, the tablets, jar, and staff onto white cardstock. Copy the ark of the covenant box, lid, and cherubim onto metallic-gold, yellow, or white cardstock.

1. Color Dagon the Philistine god and fold it in half vertically. Cut it out and glue it closed. Lay it face down and fold the upper half of the idol up at a 90-degree angle, creasing on the dotted line.
2. Color the ark of the covenant box, lid, and cherubim if you wish and cut them out. Fold and crease on the dotted lines so that the central rectangle is the bottom of the ark (the surface that will rest on the “ground”), and the “paste here” tabs fold inside the ark and overlap the long sides. Paste those tabs in place, making sure the vertical edges of the ark are aligned.
3. Fold the cherubim on the dotted lines to form a narrow rectangular base with double-sided cherubim rising above it. Paste this base onto the matching “paste here” slot on the ark lid. Now paste the cherubim back to back and trim off any white edges when they are dry. The real ark lid was not hinged, but you may wish to tape one edge of yours to the base to hold it in place.
4. Tape the straws or paper rolls to the long sides of the ark as shown to make carrying poles.
5. Color the tablets, jar, and staff and cut them out. Place them inside your ark.
6. Set your finished ark before the idol, then make Dagon fall face down on the ground before the ark.
7. *Optional:* Cut out the illustrated verse and paste it to the idol.

**MAKE IT SIMPLE:** Copy, cut, and fold the pieces ahead of time. Glue the idol shut and glue the base of the cherubim to the lid. Have four strips of tape for the poles ready at the edge of each student’s workspace. Instead of cutting out the individual contents of the ark, copy and cut out the rectangle that contains all the contents and, once it is colored, slide it as a single piece into the bottom of each ark. If need be, skip the idols and just make the arks.

**MAKE IT AMAZING:** Make ark contents from different materials. Glue tiny paper leaves and flowers to 4-inch twigs to make Aaron’s resurrected staff. Glue uncooked instant-potato flakes to the inside of a mini-cupcake liner to make the jar of manna. Paint numbers one through ten on two flat beach stones to make the Ten Commandment tablets.

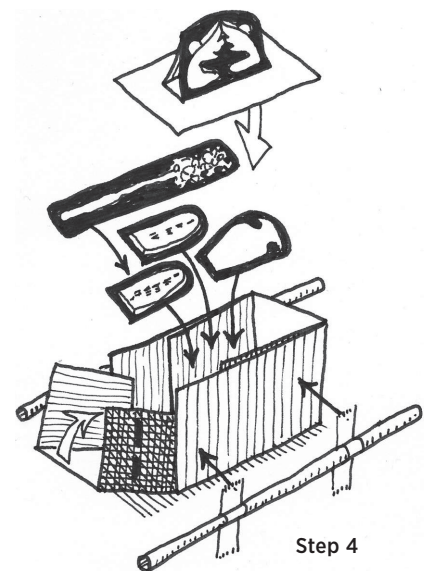
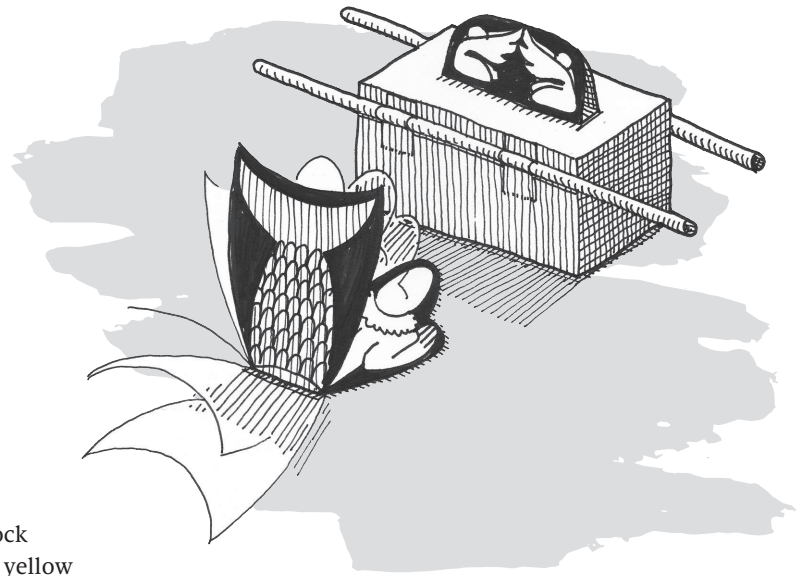

tablet template

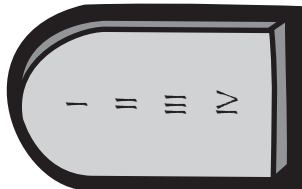

tablet template

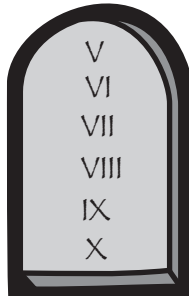

staff template

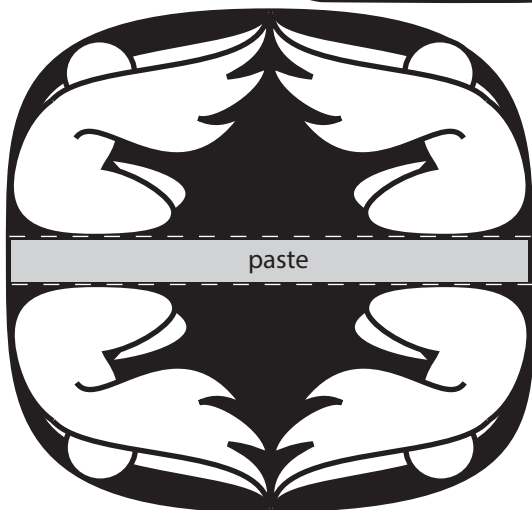
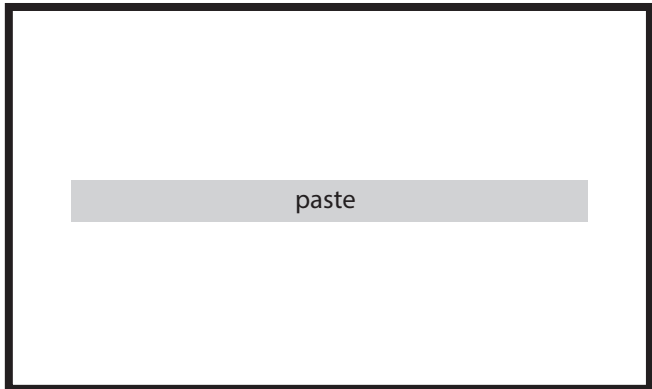

ark template

jar template

ark template

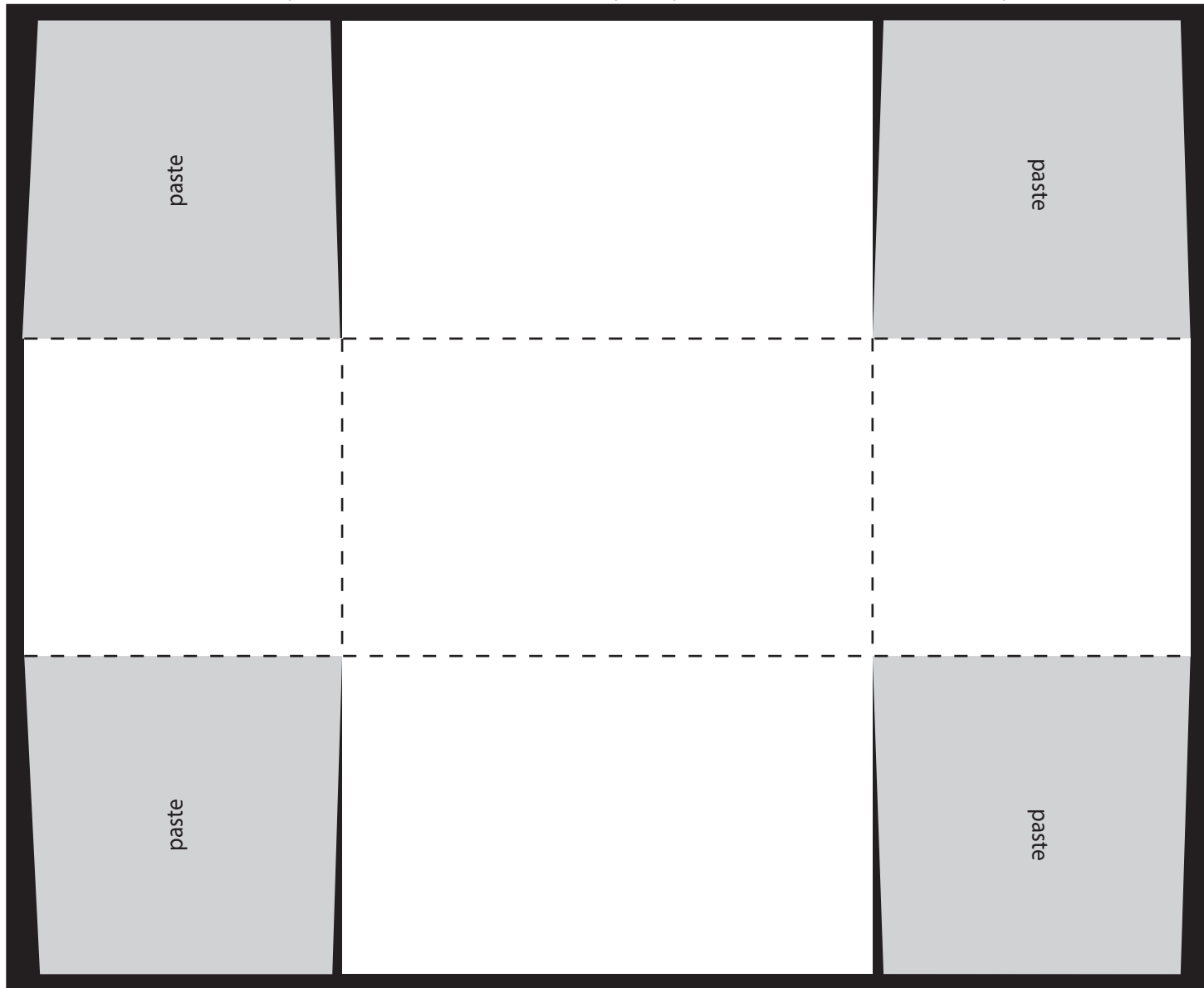



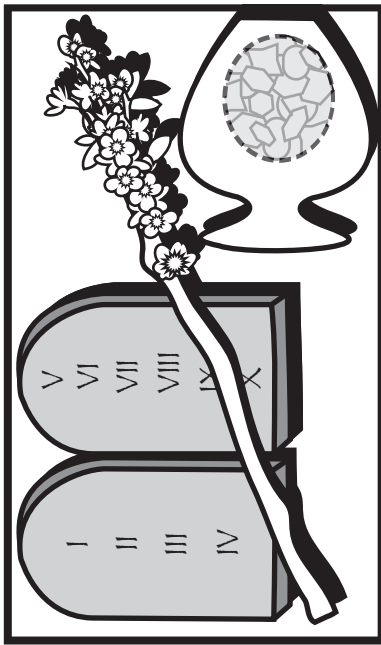

Make It Simple template

template of Dagon

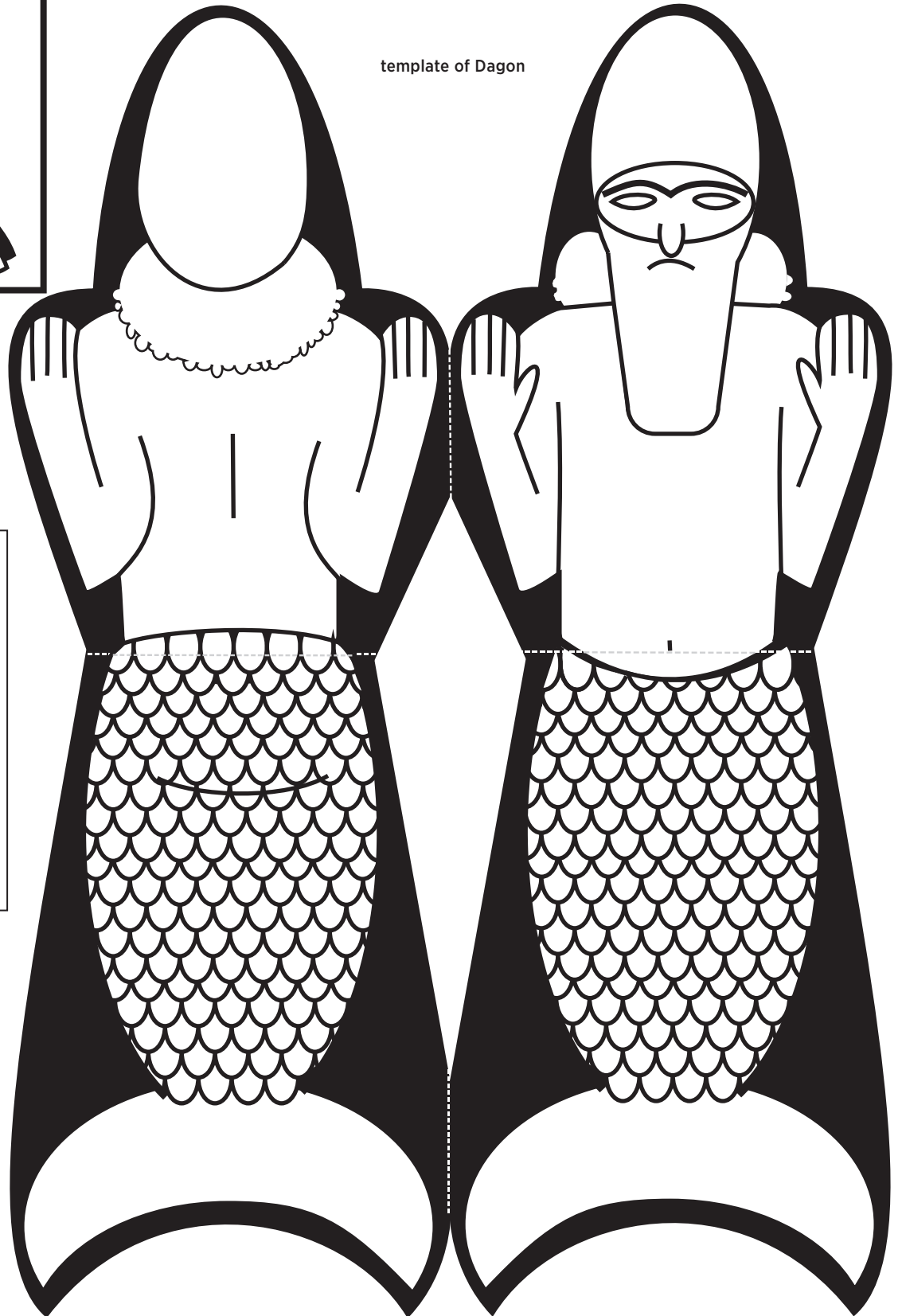

All worshipers  
of images are  
put to shame.  
**PSALM 97:7 ESV**

## GOD CHOOSES SAUL TO BE KING

1 Samuel 9–15

The LORD said . . . “They have rejected me from being king over them.” (1 Sam. 8:7)

Do not turn aside from following the LORD, but serve the LORD with all your heart. (1 Sam. 12:20)

Because you have rejected the word of the LORD, he has also rejected you from being king. (1 Sam. 15:23)

### SUPPLIES:

(to make one craft)

- 1 scalloped bulletin-board border trim, preferably metallic
- 1 sheet of white copy paper
- 3 round templates of Saul and Samuel (see below)
- crayons or markers
- scissors
- glue
- clear packing tape or stapler
- optional*: decorative stickers

### INSTRUCTIONS:

**PREP STEP:** Copy the Saul and Samuel templates onto white copy paper.

1. Cut a strip of scalloped bulletin-board trim to about 23 inches. Wrap it around your head like a crown, resting it on the ears like eyeglasses. Mark the point where it should be fastened to fit, then lay it flat to decorate it.
2. Color the three round images of Saul and Samuel and cut them out. Paste the 1 Samuel 12 circle onto the midpoint of the crown, the 1 Samuel 8 circle to its left, and the 1 Samuel 15 circle to its right.
3. Decorate the inside and outside of the crown as you wish with crayons, markers, and/or stickers.
4. Use clear packing tape or staples *with the sharp ends on the outside of the crown* to fasten it where you marked it in Step 1.

**MAKE IT SIMPLE:** Have the circles cut out ahead of class and the border trim cut to 23-inch lengths.

**MAKE IT AMAZING:** Draw more scenes from the life of Saul inside the crown or on additional glued-on circles: Saul offering David his armor to fight Goliath, Saul and Jonathan in battle, Saul hunting David, and so forth.



Saul and Samuel template

## GOD CHOOSES DAVID TO BE KING

1 Samuel 16

Man looks on the outward appearance, but the LORD looks on the heart. (1 Sam. 16:7)

### SUPPLIES:

(to make one craft)

- 6- to 9-inch cardboard box such as one for tissues or cake mix
- butcher paper or a paper grocery bag
- scissors
- clear packing tape
- template of David (see page 84)
- 1 sheet of white copy paper
- crayons or markers
- glue
- optional: heart-shaped stickers
- 3-4 rubber bands
- 1 plastic drinking straw

### INSTRUCTIONS:

**PREP STEP:** Copy the template of David onto white paper.

1. Make a lyre by cutting a large circle from the center of the largest panel of a 6- to 9-inch cardboard box (unless, as in the case of a tissue box, there is already a suitable hole). Wrap the box in butcher or grocery-bag paper, securing the edges with clear packing tape. Cut out the paper that is over the hole.
2. Stretch three or four rubber bands around the lyre so that they pass over the hole. The bands should be tight enough to stay in place, but not so tight that they crush the box. Cut the straw to a length that is just shorter than the width of your box, and slip it under (and perpendicular to) the rubber bands near the edge of the hole as shown.
3. Increase or decrease the tension on each rubber band so that it plays a different note from its neighbors when plucked. Each rubber band's tension can be adjusted by gently pulling it tighter or looser from one edge of the box to the next (which will make it slightly looser or tighter respectively on the opposite side of the box). The tighter each rubber band is stretched across the face of the box, the higher the note it will play.
4. Color and cut out the picture of David and lay it face down. Run lines of glue only down the long edges of the rectangle. Attach the picture to the back of the lyre by its long edges only, so that the rubber bands pass under it but are not glued down. This way you can see your colored picture with no rubber bands covering it, and you can also adjust the tension of your rubber bands when necessary.
5. *Optional:* Cut out the illustrated verse and paste it to your lyre.

**MAKE IT SIMPLE:** Cut the holes and wrap the boxes ahead of time so that they are ready to be decorated. Alternately, you may purchase small, identical corrugated cardboard boxes in bulk and assemble ahead of time. These will have clear surfaces ready to decorate (allowing you to skip covering them in brown paper) but will still need holes cut ahead of time.

**MAKE IT AMAZING:** Use a sturdy 5 x 7 picture frame (with no glass or backing) as your lyre instead of the box.

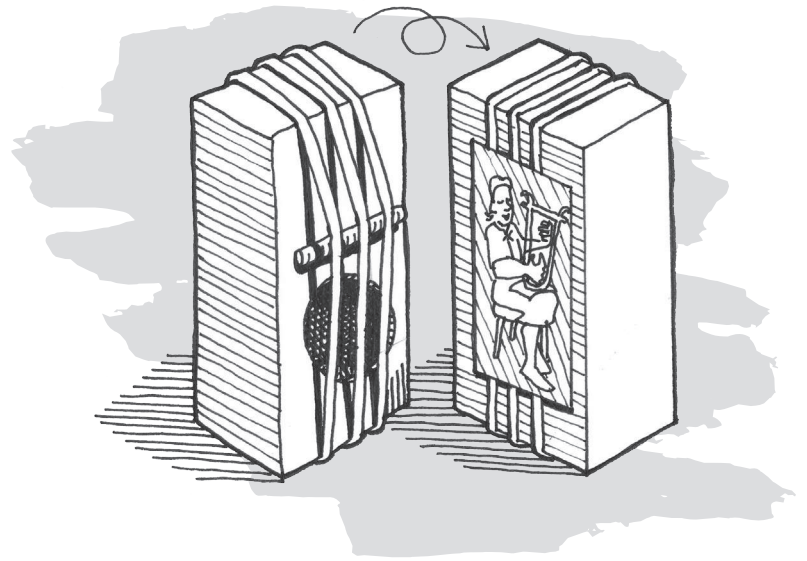



David template



Man looks on the outward  
appearance, but the LORD  
looks on the heart.

**1 SAMUEL 16:7 ESV**

## GOD DELIVERS ISRAEL FROM THE PHILISTINES

### 1 Samuel 17

For you equipped me with strength for the battle.  
(Ps. 18:39)

#### SUPPLIES:

(to make one craft)

- 1 sheet of white cardstock
- templates of shepherd's pouch, sling, five stones, and battle scene (see pages 86–87)
- crayons or markers
- scissors
- glue or paste

#### INSTRUCTIONS:

**PREP STEP:** Copy the pouch, sling, stones, and battle scene templates onto white cardstock.

1. Color the pouch and battle scene and cut all the images out. Fold the shepherd's pouch in half on the dotted line.
2. Paste the battle scene, sling, and five stones where you want them inside the pouch.

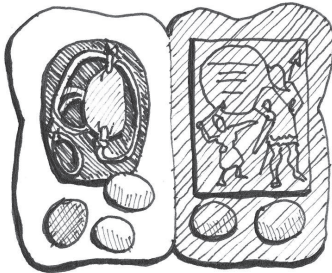

Step 2

**MAKE IT SIMPLE:** Cut everything out ahead of time. Cut out the five stones as a single piece.

**MAKE IT AMAZING:** Make an actual pouch from faux leather, sewing or gluing the sides and securing the pouch with a leather craft thong, with or without lacing it through the top edges of the pouch. Or, if you use a large enough piece of fabric, you can simply cinch the edges together with a craft thong to make your pouch without needing to sew or glue. Fill it with five real stones and a sling (made from thong or twine and a scrap of faux leather).



Make It Amazing

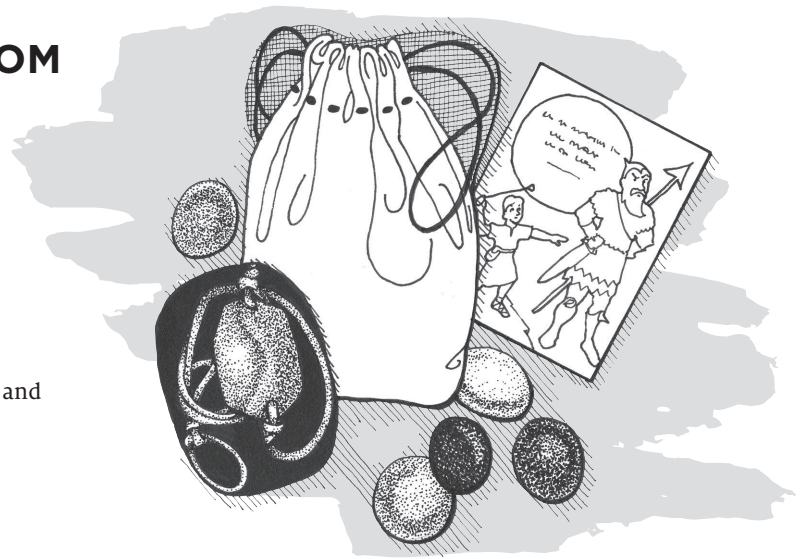



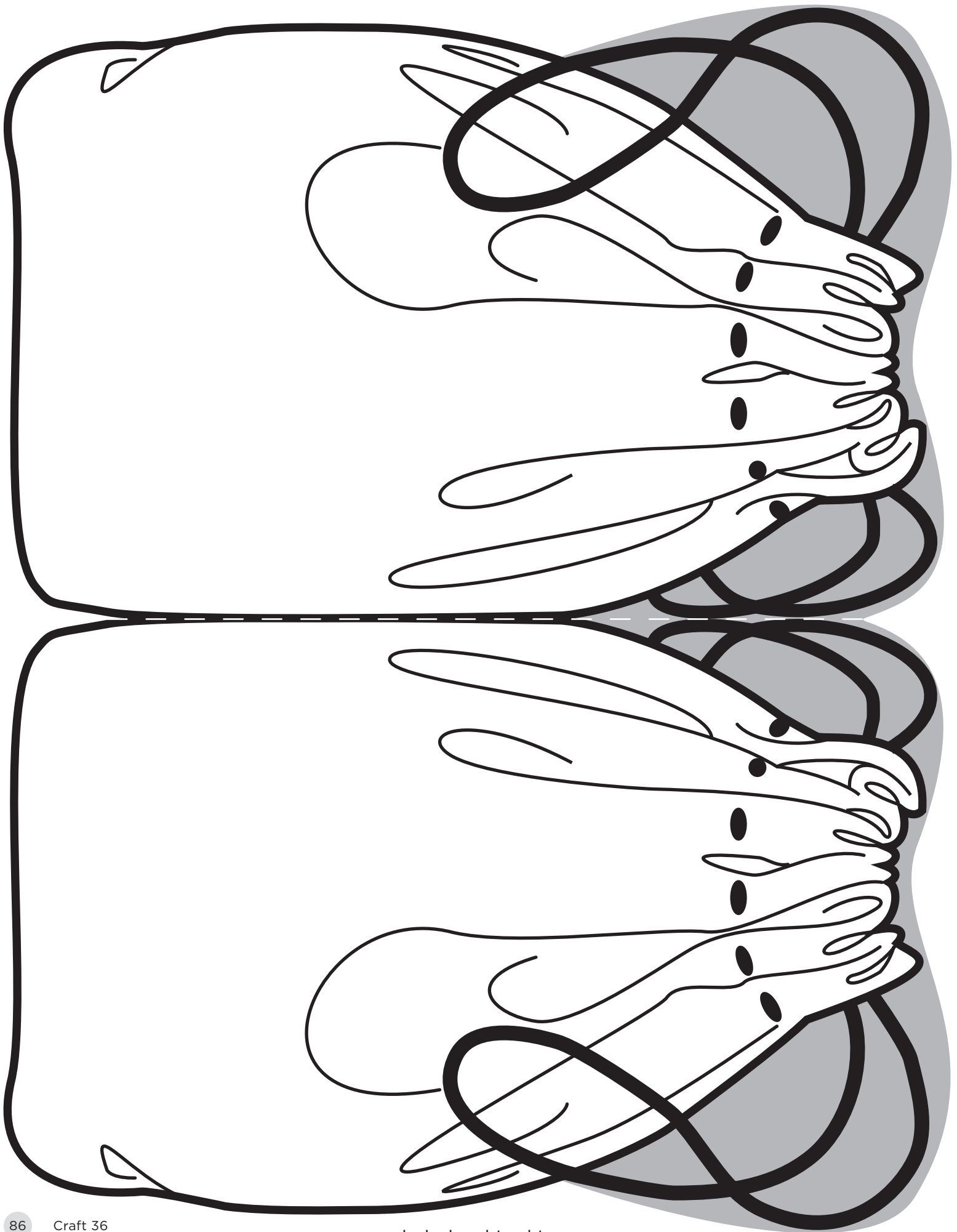

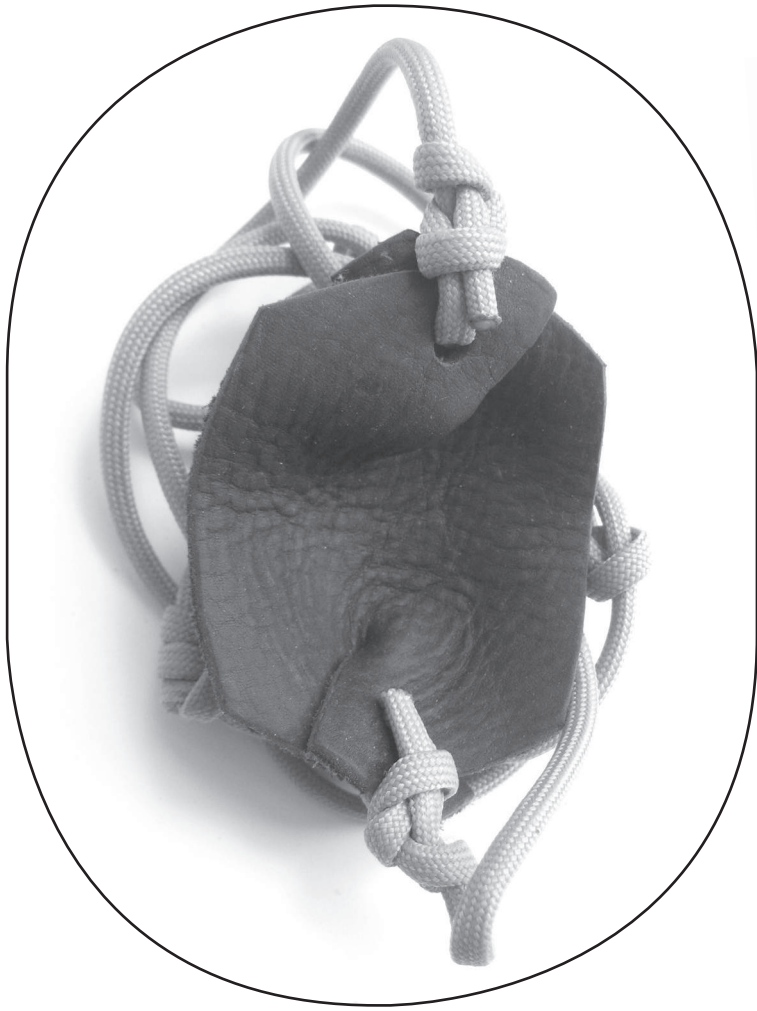

sling template



stones template

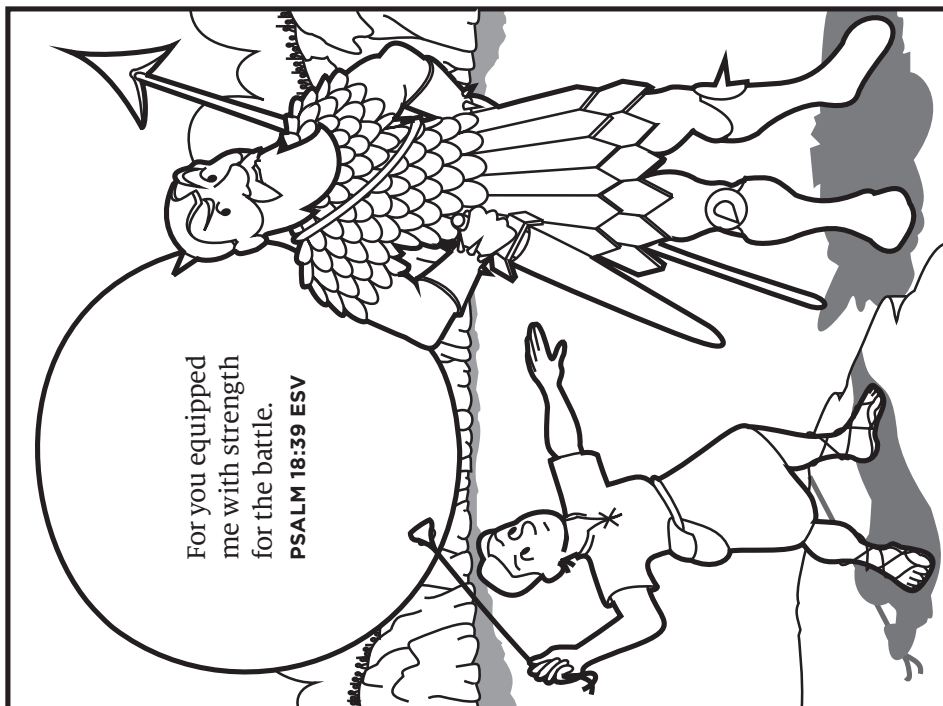

battle scene template

## GOD PROVIDES A FRIEND FOR DAVID

1 Samuel 18:1-5; 19:1-10; 20

A friend loves at all times. (Prov. 17:17)

### SUPPLIES:

(to make one craft)

- cardboard or cardstock
- templates of arrowhead, feathers, and David and Jonathan (see page 89)
- scissors
- 2 sheets of paper or cardstock, any color
- 3 drinking straws, preferably not bendable
- tape
- optional: clear packing tape
- 55-inch length of curling ribbon
- optional: stapler
- crayons or markers
- glue

### INSTRUCTIONS:

**PREP STEP:** Copy the template of David and Jonathan onto white paper.

1. Cut three arrowheads similar to the template from cardboard or cardstock. Cut three “feathers” similar to the template from paper of any color. Cut a ½-inch slit in one end of a drinking straw, insert an arrowhead, and tape it in place. Cut a 1 ½-inch slit facing the same direction in the other end of the straw, insert feather, and tape it in place. Fringe the feathers with parallel diagonal cuts. Create two more arrows by repeating this process with two more straws.

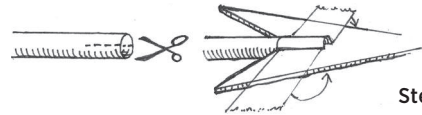

Step 1

2. Create a quiver: Loosely roll a full sheet of colored paper or cardstock to form a cylinder, overlapping the short ends of the paper by an inch and fastening them the length of the seam with a strip of packing or regular tape. Pull a 55-inch length of curling ribbon halfway through the cylinder. Flatten one end of the cylinder and staple or tape it shut with the ribbon centered.

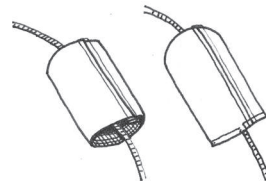

Step 2

3. Color David and Jonathan and cut them out. Paste them onto your quiver. Decorate the rest of the quiver with crayons or markers. Decorate the three arrows as well.

4. Wear your quiver like Jonathan by placing it on your back with the open side up, and run the ribbon over one shoulder and under the other. Tie the ribbon ends together in front of your chest and place your three arrows in your quiver.

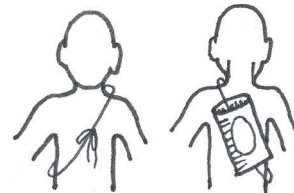

Step 4

**MAKE IT SIMPLE:** Construct the arrows ahead of time, but let students fringe them if they are able. Construct the quivers ahead of time and don't worry if they are flattened a bit when they are colored—they will still hold the arrows.

**MAKE IT AMAZING:** Draw more scenes from David's life on the quiver: David and Goliath, David and Abigail, David sparing Saul in the cave or in the camp at night, David becoming king of Judah and Israel, David dancing before the ark, David and his mighty men, David singing praises to God, and so forth.





A friend loves at all times.  
PROVERBS 17:17 ESV

David and Jonathan template

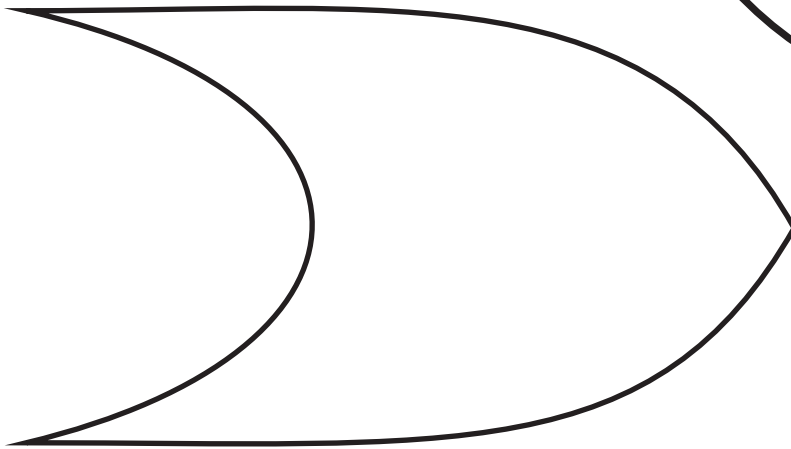

feathers template

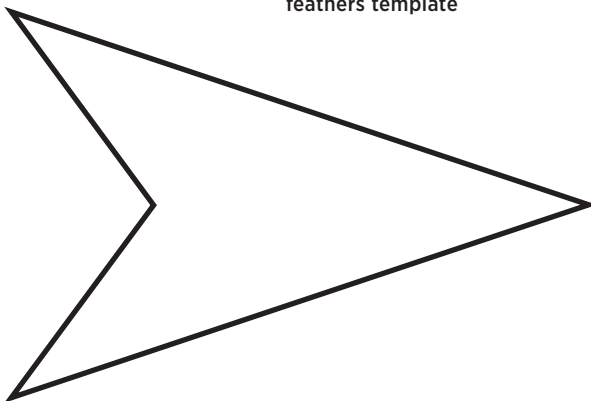

arrowhead template

## GOD CHOOSES SOLOMON TO BUILD THE TEMPLE

1 Kings 5:1-9:9; 2 Chronicles 2-7

Without the shedding of blood there is no forgiveness of sins. (Heb. 9:22)

### SUPPLIES:

(to make one craft)

- 1 sheet of white cardstock
- 1 sheet of yellow, gold, or white cardstock
- templates of interior and exterior temple and its furnishings (see pages 91-92)
- crayons or markers
- scissors
- clear packing tape or regular tape
- glue
- a 3 x 3 ½-inch rectangle of blue, purple, or scarlet felt or other fabric

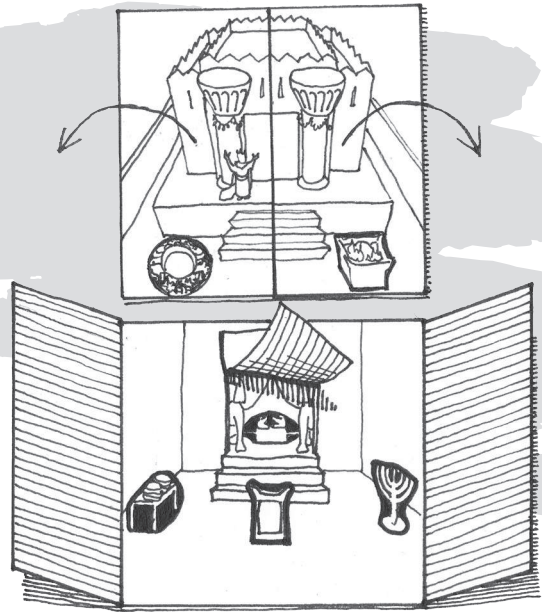

### INSTRUCTIONS:

**PREP STEP:** Copy the template of the temple exterior onto white cardstock. Copy the template of the temple interior onto yellow, gold, or white cardstock.

1. Color the temple and cut out its two large rectangular panels, along with the altar and sea basin.
2. Color the interior temple image if desired and cut out the large square panel and four furnishings.
3. Place the exterior panels atop the interior panel and align all edges, trimming if necessary. Use tape to attach the outer vertical edges of the exterior panels to the left and right edges of the interior panel as pictured, so that the temple exterior opens in the center to reveal the temple interior.
4. Paste the six temple furnishings where they belong. Glue the top edge of the fabric “curtain” above the entrance to the Most Holy Place where indicated so that it can be lifted to reveal the ark inside.
5. *Optional:* Cut out the illustrated verse and paste it to your craft.

**MAKE IT SIMPLE:** Copy, cut, and tape the interior/exterior panels ahead of time. Cut out the six furnishings ahead of time.

**MAKE IT AMAZING:** Copy the furnishings onto gold and bronze metallic papers instead of white paper. Add tissue-paper flames to the sacrifice on the altar.



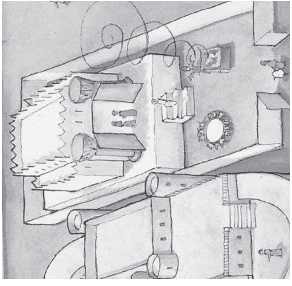

Without the shedding  
of blood there is no  
forgiveness of sins.  
**HEBREWS 9:22 ESV**

temple furnishings templates

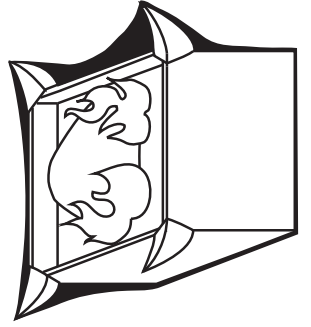
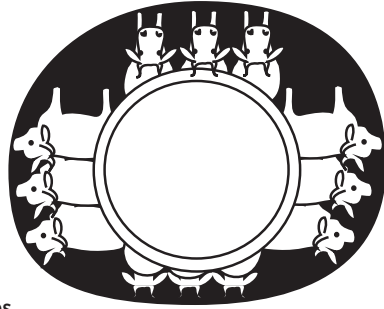

exterior temple templates

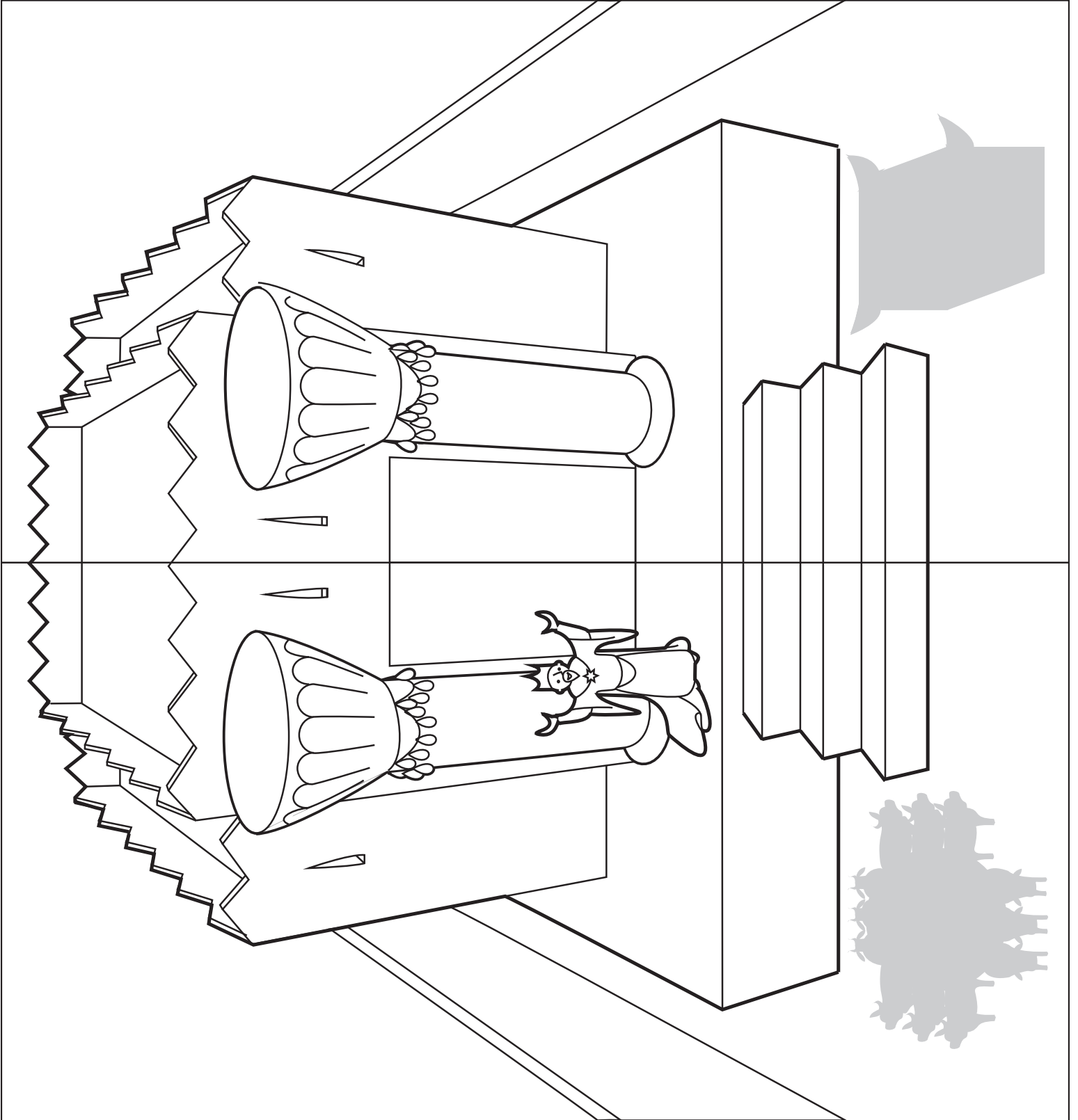

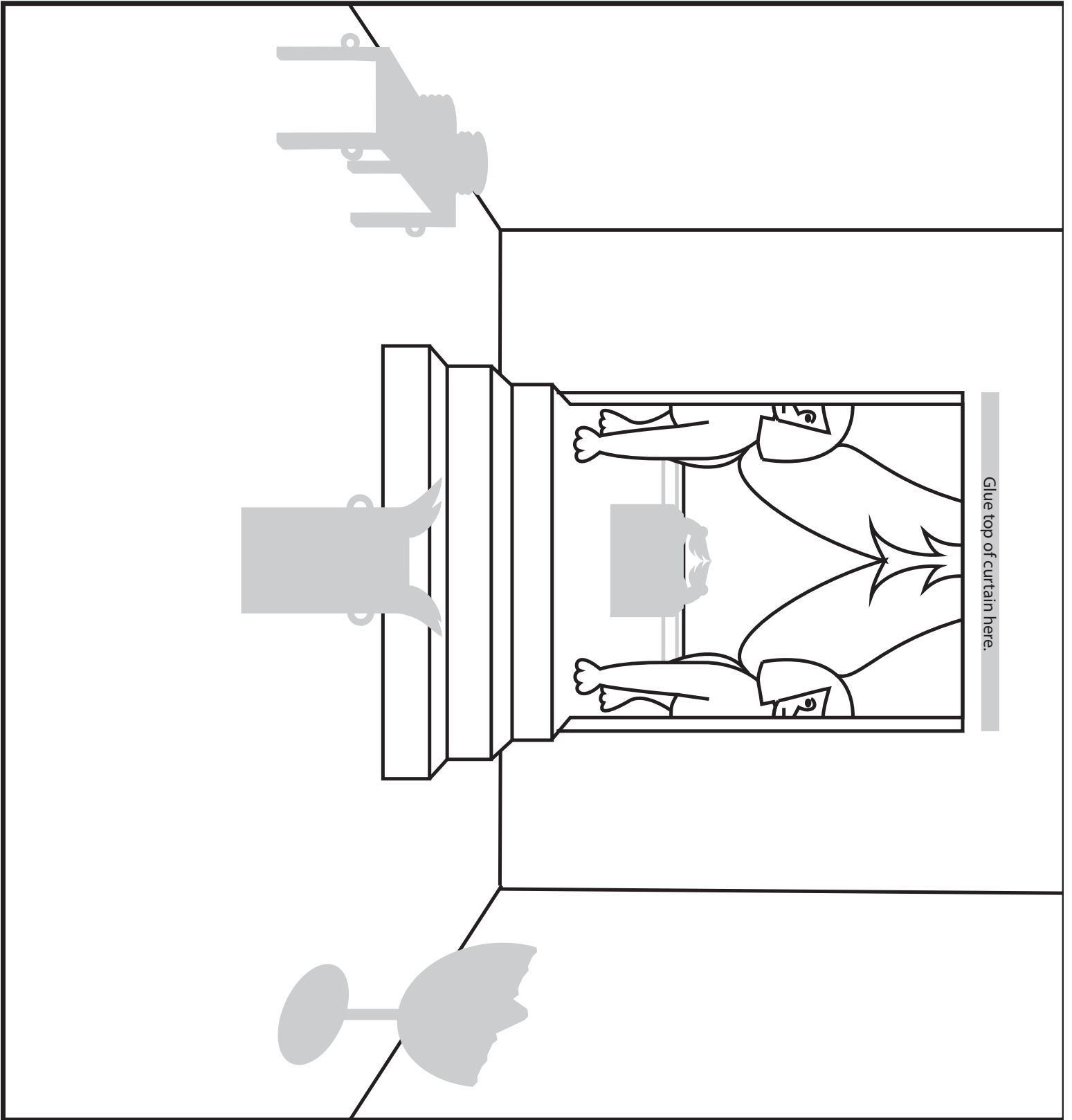

Glue top of curtain here.

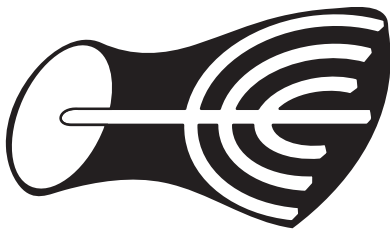
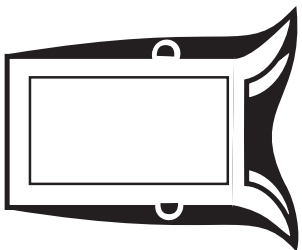

## GOD WITHHOLDS DEW AND RAIN

1 Kings 17:1-7

The prayer of a righteous person has great power as it is working. (James 5:16)

### SUPPLIES:

(to make one craft)

- 1 sheet of white paper
- template of raven (see page 94)
- 1 sheet of black cardstock or paper
- scissors
- optional*: craft knife such as X-Acto™
- crayons or markers
- scissors
- tape or hot-glue gun
- 1 cracker or piece of stale tortilla
- 1 small bit of jerky
- optional*: 2 small googly eyes

### INSTRUCTIONS:

**PREP STEP:** Copy the raven template onto white paper.

1. Use the copy of the raven to cut a raven silhouette from black cardstock or paper. Use a craft knife or scissors to cut the thick slit. Color the raven if you wish.
2. Cut an approximately 6 x 9-inch rectangle from black cardstock and accordion-fold it lengthwise, with each fold about  $\frac{3}{4}$  inch from the next. Thread the folded paper halfway through the slit in the raven's body, then open the folds a bit on either side to form wings.
3. Tape or hot glue a bit of cracker or tortilla to the raven's beak and a bit of jerky to its talons. Now it is ready to feed Elijah during the famine.
4. *Optional*: Glue small googly eyes to either side of the raven's head.
5. *Optional*: Cut out the illustrated verse and glue it to the raven.

**MAKE IT SIMPLE:** Stack several layers of black cardstock in order to cut out several ravens at once. Accordion-fold several stacked rectangles at once, then unfold and let students refold on the creases.

**MAKE IT AMAZING:** Cut the raven shape from thin cardboard and paint it black, or glue together several layers of black cardstock to make a strong raven body. Once you have added the paper wings, googly eyes, and bits of food, poke a pin-sized hole through the raven's shoulder and thread fishing line or dental floss through to form a long hanger. Find the right place for the hole by pinching the raven from above to see if it tips forward or backward, then move the pinch until you find the correct point of balance. Make and suspend a small flock of ravens on their way to Elijah.

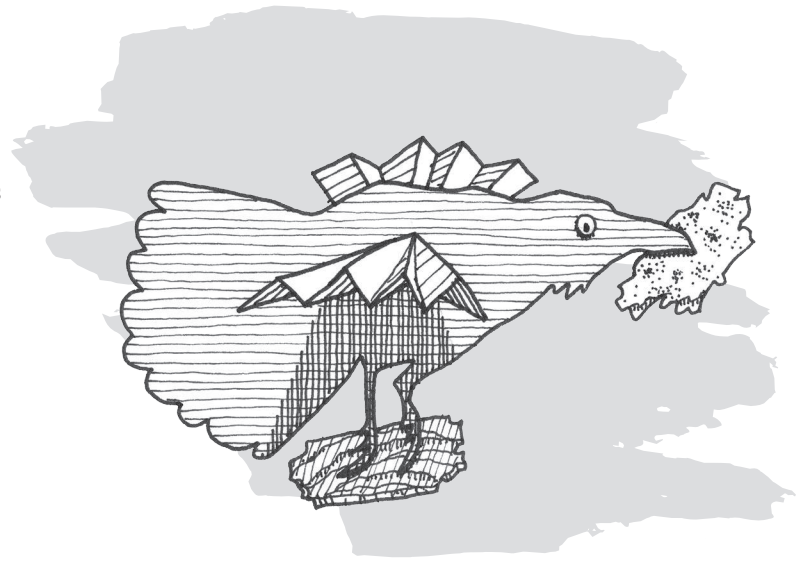



The prayer of a righteous person has great power as it is working.  
**JAMES 5:16 ESV**

raven template

## GOD DISPLAYS HIS POWER OVER BAAL

1 Kings 18:20–40

The LORD, he is God; the LORD, he is God. (1 Kings 18:39)

### SUPPLIES:

(to make one craft)

- 2 sheets of white cardstock
- templates of altar and burnt offering (see pages 96–97)
- scissors
- tape
- 1 sheet of blue cardstock or paper
- glue
- 1 disposable plastic grocery bag
- crayons or markers
- optional*: small sticks, toothpicks, or bamboo skewers
- yellow, red, and/or orange tissue paper

### INSTRUCTIONS:

**PREP STEP:** Copy the altar and bull offering templates onto white cardstock.

1. Trim off the white edges from the altar. Flip it over and fold inward on each of the nine parallel dotted lines. Fold inward on the two long dotted lines that are perpendicular to the first nine folds. Slit the creases on the solid lines to form ten flaps on each long edge of the altar. Curl the altar into a cylinder and tape the edge closed, but not the flaps.

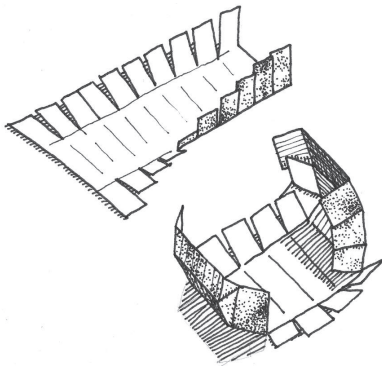

Step 1

2. Make the “water-filled trench” by cutting a circle from blue cardstock, about 5 inches in diameter. Choose one end of the altar to be the bottom and put glue on the printed side of each of its ten flaps. Overlap the flaps and set the altar down in the middle of the trench. Open the top flaps outward so you can reach down inside to press all the bottom flaps down onto the trench and each other. When the glue is dry, gently stuff a plastic grocery bag into the altar to keep it from smashing inward. Flip the top flaps inward, overlapping them to close the altar, and glue or tape them in place. Color the altar if you wish, perhaps drawing blue water running down the sides.

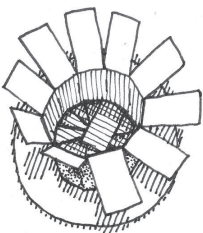

Step 2

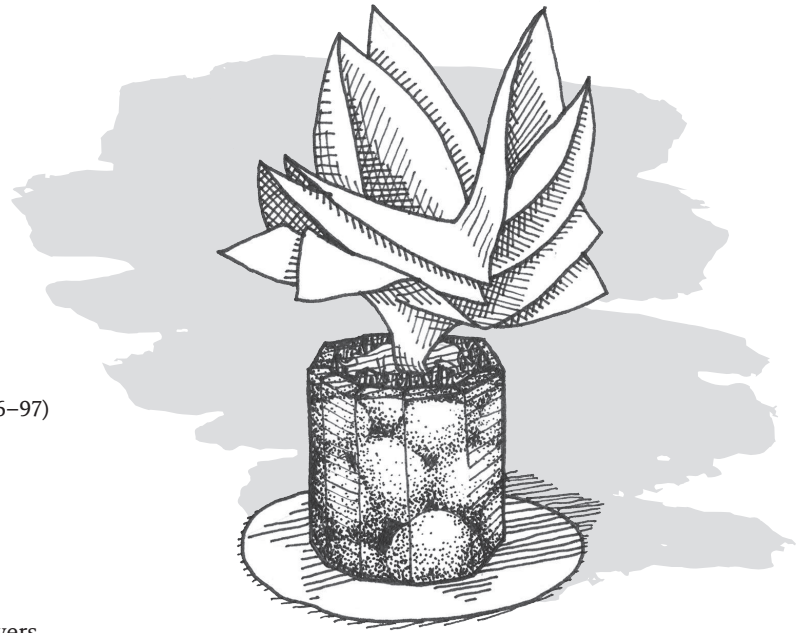



3. Color and cut out the bull offering on the woodpile. (*Alternately*, glue toothpicks, sticks, or pieces of bamboo skewer to the top of the altar and cut out only the bull.) Gently fold it in half but don't crease it, and use scissors to cut a slit anywhere through the center. Cut squares of the fire-colored tissue paper at least 7 inches long. Center them over one another, but rotate some so that the corners do not match up. Pinch all of them hard in the center and pull all the corners away from the pinch to form a large tuft of flames. Pull a bit of the pinched end through the slit you made in the bull offering, and tape it to the underside. Place the offering on the altar and glue it down. Arrange the flames leaping upward from the altar and sacrifice.

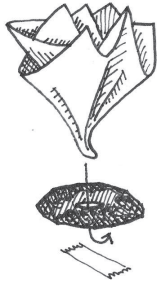

Step 3

4. *Optional*: Cut out the illustrated verse and glue it to the altar.

**MAKE IT SIMPLE:** Constructing the altar can be time-consuming for little ones whose fine motor skills are still developing, so complete the first half of the construction before class. You can cut and fold several at one time. Bring the altars to class already glued to the trenches, then let students stuff the bags in (explaining that real altars were stuffed with rocks) and close the top flaps. Have offerings ready to color and tissue paper cut to size.

**MAKE IT AMAZING:** Make two altars, and don't put a trench of water or fire on the altar to Baal. Use blue glitter or metallic paper for the water under Elijah's altar, and paint additional streams of water on the stones with blue glitter glue. Collect twigs to use as the branches under the offerings.



burnt offering template



The LORD, he is God; the LORD, he is God.  
**1 KINGS 18:39 ESV**



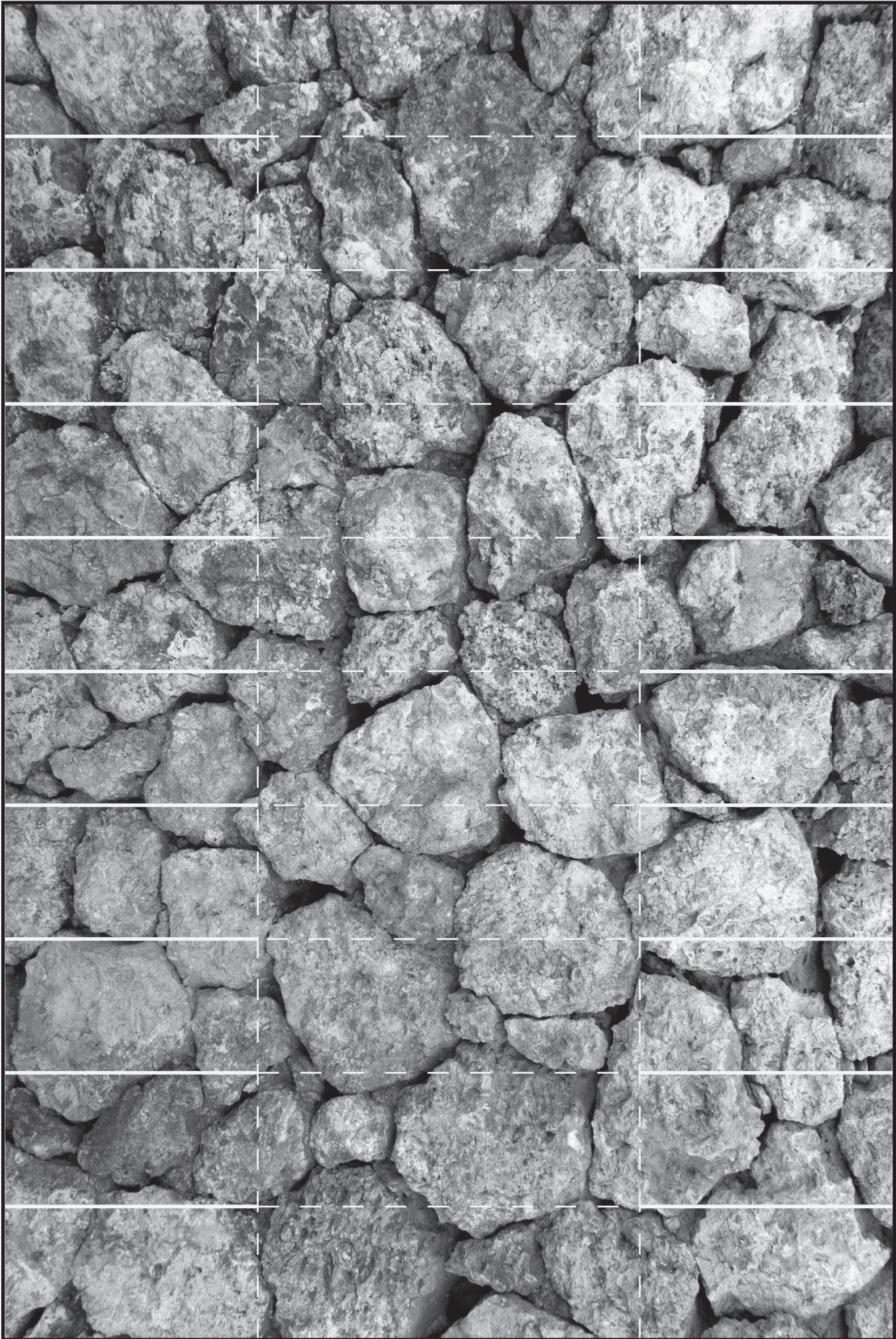

altar template



## GOD TAKES ELIJAH TO HEAVEN

2 Kings 2:1-18

Elijah . . . said, "O LORD, . . . let it be known this day that you are God . . . and that I am your servant."

(1 Kings 18:36)

### SUPPLIES:

(to make one craft)

- 1 sheet of white cardstock
- templates of horses with their heads (see page 99)
- red, orange, and yellow crayons or markers
- scissors
- glue
- red, orange, and yellow tissue paper
- optional: double-sided tape

### INSTRUCTIONS:

**PREP STEP:** Copy the templates of the fiery whirlwind horses and their heads onto white cardstock.

1. Color the horses yellow, orange, and red and cut them out. Fold outward on the dotted lines to make them stand up. Put glue on the marked areas and attach the heads below the ears.
2. Stack red, orange, and yellow tissue paper and cut four 3-inch squares from each color (a total of twelve squares). Pinch each square at its center and pull the corners away from the pinches to form tufts of flame. Run a strip of glue or double-sided tape down the necks and tails of the horses and attach the tissue tufts to the two horses to create their manes and tails.

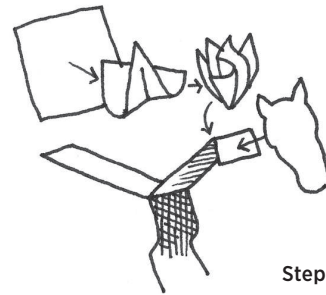

Steps 1 and 2

3. *Optional:* Add flame tufts to the horses' ankles as well. Cut out the illustrated verse and glue it to the whirlwind.

**MAKE IT SIMPLE:** Have each student make one horse rather than two. Either of the provided horse templates may be enlarged up to 140 percent and still fit on a single sheet of cardstock. Cut out horses, glue on heads, and cut tissue squares ahead of time.

**MAKE IT AMAZING:** Make the chariot from "Craft 93: God Uses Philip to Teach a Man from Ethiopia," reducing the size to 80 percent before copying and excluding the men inside. Make four or six horses instead of two, and cut away the area between the bottom clouds and the horses' bellies so that you can see all four legs at once. Use string to "harness" the horses to the chariot if you wish.

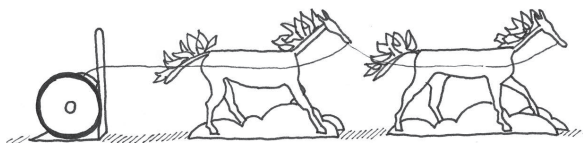

Make It Amazing

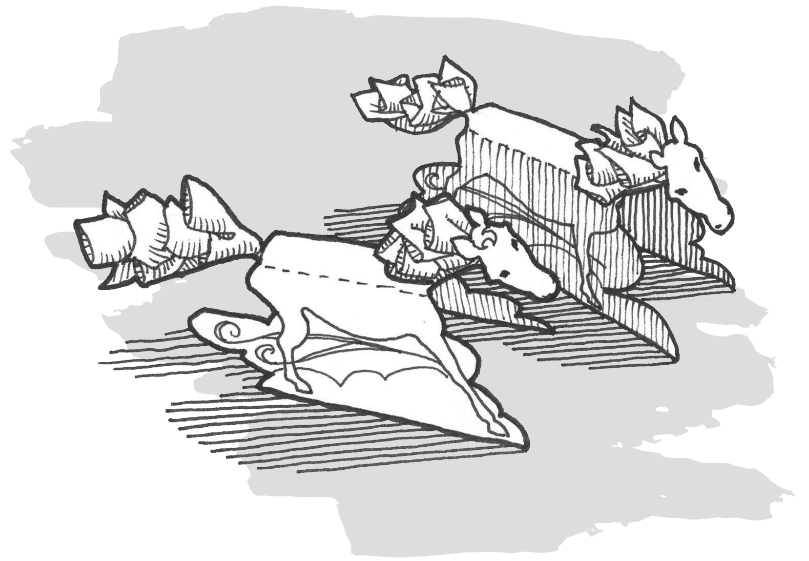



Elijah . . . said, "O LORD . . . let it be known this day that you are God . . . and that I am your servant."  
1 KINGS 18:36 ESV

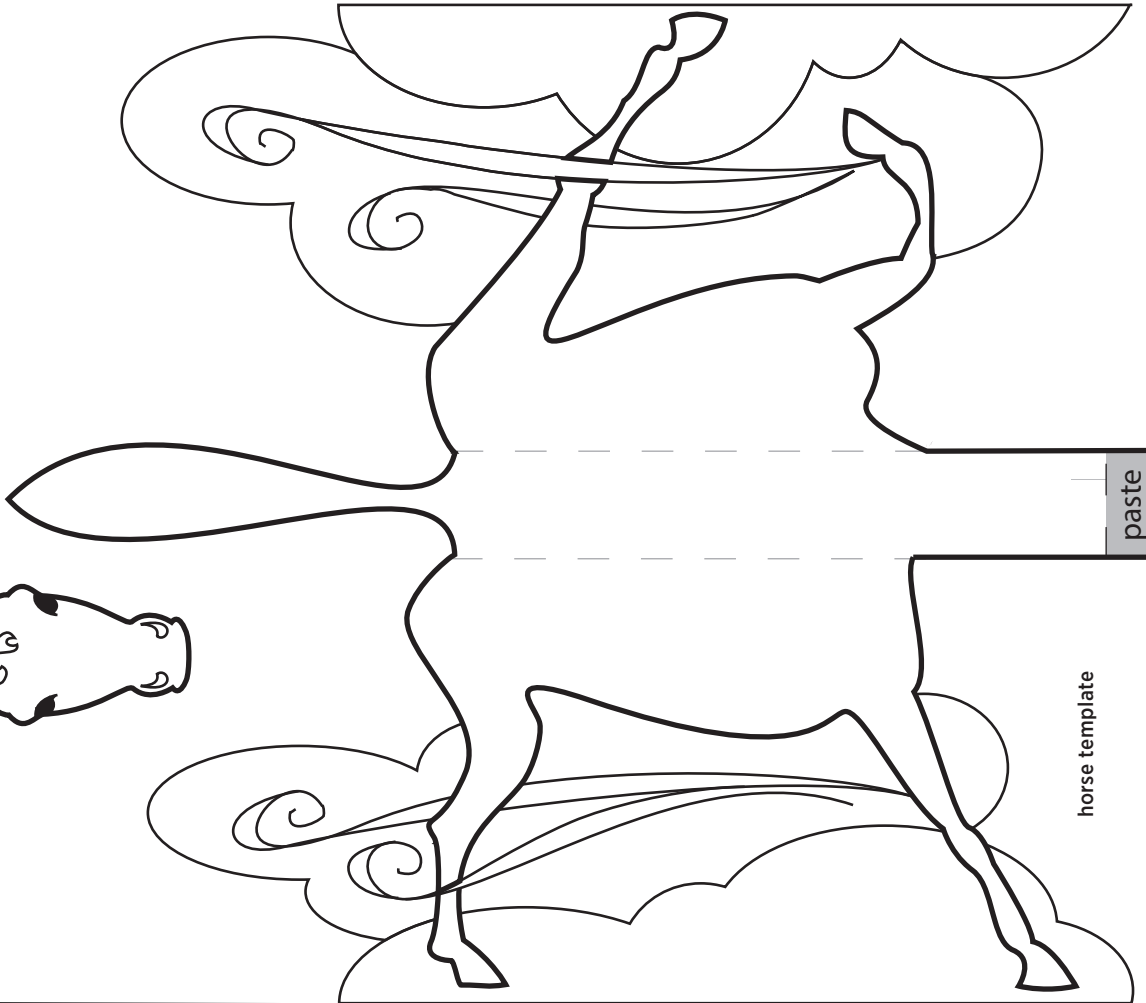
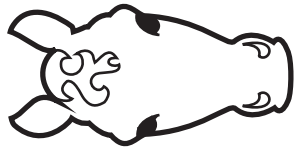

horse template

paste

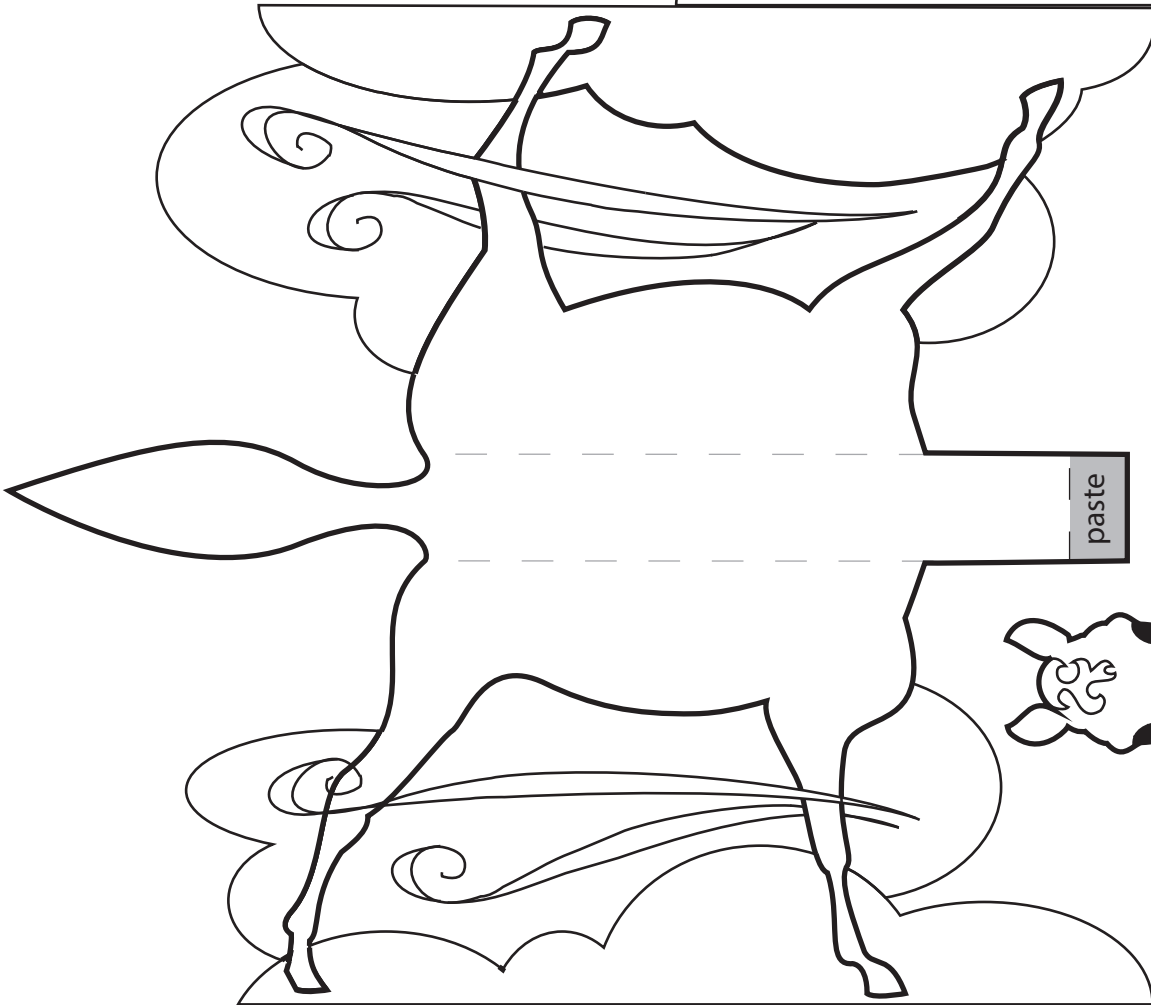

horse template

paste

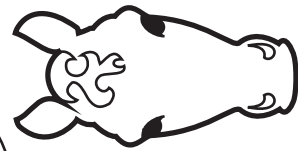

## GOD PERFORMS MIRACLES THROUGH ELISHA

2 Kings 5:1-19

A wise man listens to advice. (Prov. 12:15)

### SUPPLIES:

(to make one craft)

- 1 sheet of white cardstock
- template of Naaman (see page 101)
- red marker
- scissors
- crayons or markers
- 1 bamboo skewer or drinking straw
- tape
- optional: stapler
- 1 sheet of blue paper

### INSTRUCTIONS:

**PREP STEP:** Copy the Naaman template onto white cardstock.

1. Use a red marker to create sores all over the skin of "sad Naaman."
2. Cut out the rectangle containing both versions of Naaman and color them. Fold on the dotted line.
3. Unfold the rectangle and tape a skewer or straw down the center of the back of one Naaman, with the skewer reaching from the crease to at least 5 inches below the rectangle. Fold the other Naaman back down over the skewer and use tape or staples to secure him there. You now have back-to-back Naamans on a long handle.

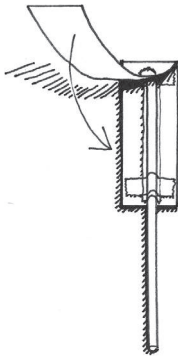

Step 3

4. Create a section of the Jordan River: Cut wave-shaped scallops from the short edges of a sheet of blue paper, then fold it in half crosswise and tape the edges closed to form a pocket. Cut a small hole in the center of the crease at the bottom of the pocket.

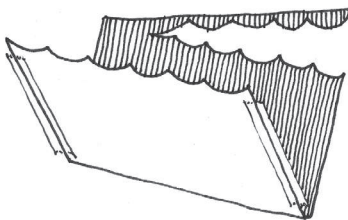

Step 4

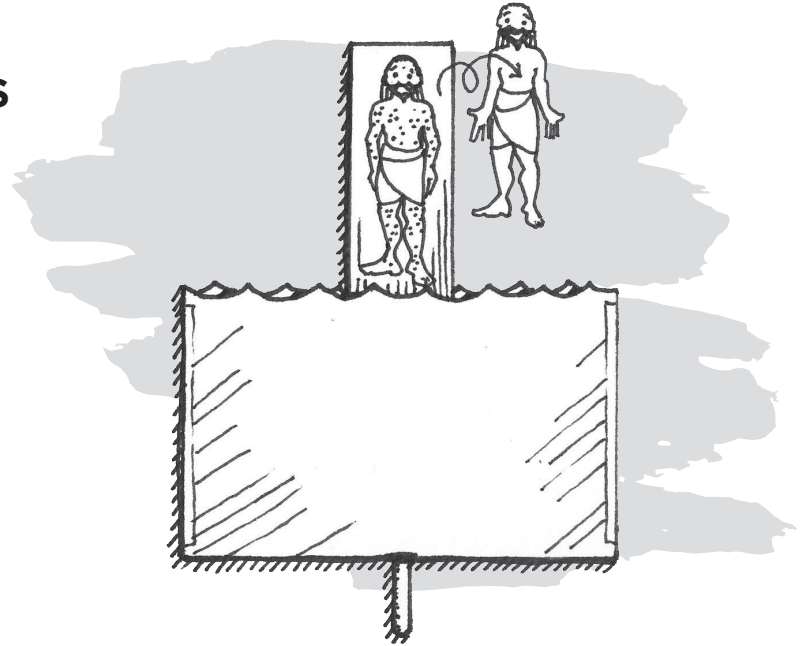



5. Lower the skewer down through the hole in the paper-pocket river and use it as a handle to “dip” Naaman into the Jordan six times with leprosy, then after a seventh time, flip the picture so that he is healed.

6. *Optional:* Cut out the illustrated verse and glue it to the water.

**MAKE IT SIMPLE:** Create the rivers and cut out the Naaman rectangles ahead of time.

**MAKE IT AMAZING:** Use a large paper or styrofoam cup rather than the blue paper and paint it blue with acrylic or other water-based paint. Draw and then cut out a wavy water line near the rim. Use paint or markers to add water plants and/or fish.

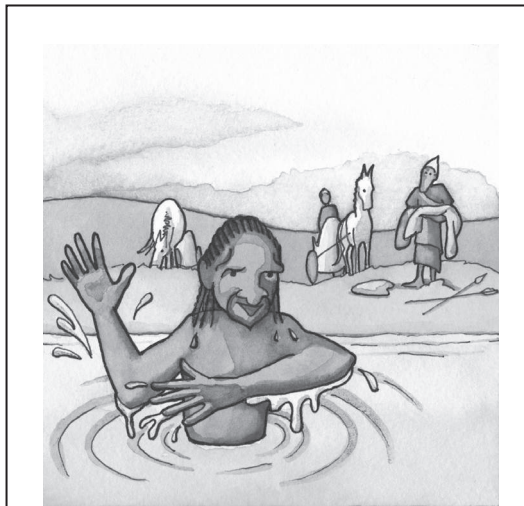

A wise man listens to advice.  
**PROVERBS 12:15 ESV**

Naaman template

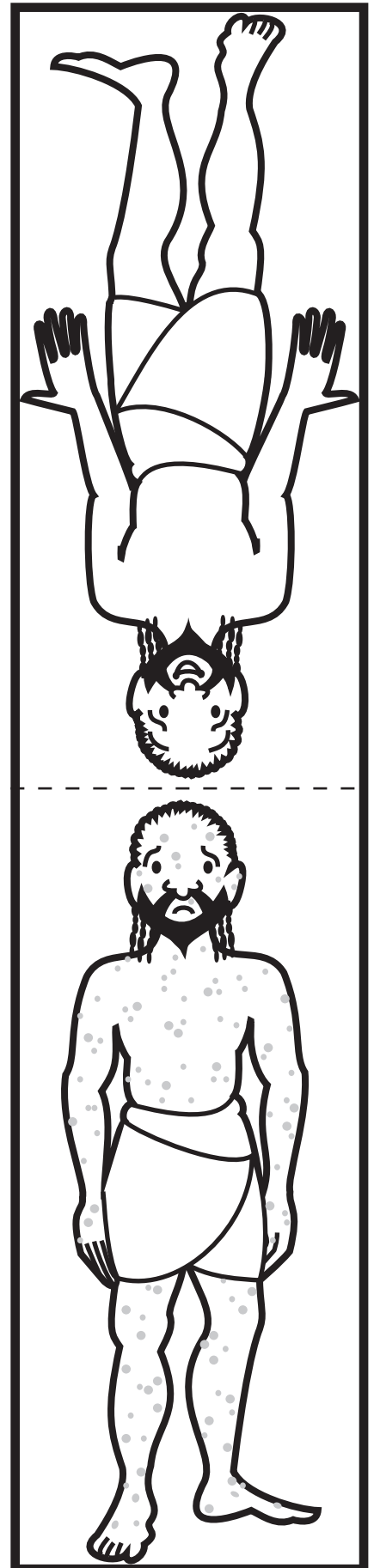

## GOD TEACHES JOB AND HIS FRIENDS

*Job 1-42*

The LORD gave, and the LORD has taken away; blessed be the name of the LORD. (Job 1:21)

### SUPPLIES:

(to make one craft)

- 1 sheet of tan, brown, or white cardstock
- crayons or markers
- scissors
- bubble wrap with small bubbles
- glue or double-sided tape
- 1 red marker or crayon
- 1 sheet of white copy paper
- templates of animals and Job's family (see page 103)



### INSTRUCTIONS:

**PREP STEP:** Copy Job's family and animal templates onto white copy paper. You may want to reduce the size of the figures for smaller hands.

1. Fold a sheet of tan, brown, or white cardstock in half. Take a crayon in your writing hand and place the other on the paper, fingers spread slightly, so that the crease of the paper runs along the outside edge of your pinky finger. Trace your hand and wrist, then cut out the hand shape with the paper still folded and the crease uncut.

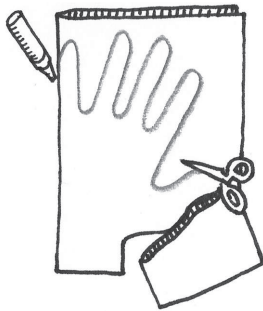

Step 1

2. Carefully cut some individual bubbles from the bubble wrap without puncturing them. Stick them here and there on the outside of the folded hands using double-sided tape or glue. Color the area immediately around the bubbles red so that they look like blisters. *Optional:* Leave space to glue on the illustrated verse if you wish.
3. Color the people and animals and cut them out. Unfold the hands so that they are open to worship and receive blessings from God. Glue the people and animals into the open hands. If your hands are small, you may need to overlap the figures. (*Alternately*, trace an adult's hand instead of yours.)
4. *Optional:* Cut out the illustrated verse and glue it to your paper hands.

**MAKE IT SIMPLE:** Trace and label their hands as students enter the classroom, then have an assistant cut them out during story time. Consider just drawing sores and scrapes on the hands instead of attaching blisters. Have the figures cut out and ready to color.

**MAKE IT AMAZING:** Copy and cut out seven thousand sheep, three thousand camels, five hundred yoke of oxen, and five hundred donkeys. *Just kidding!*

Job's family template

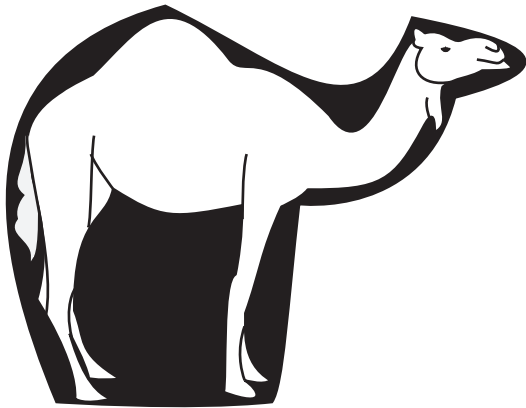

animal templates

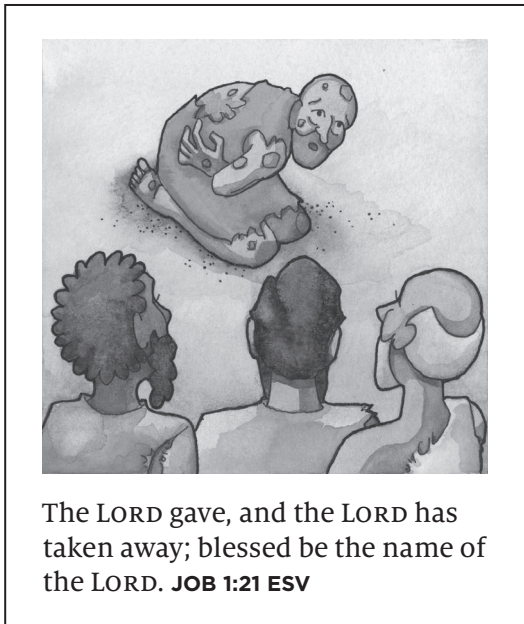
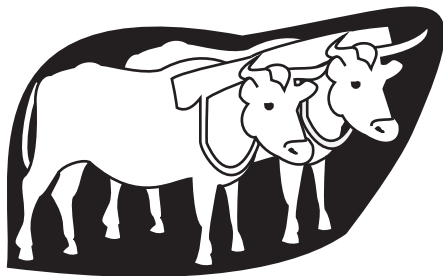

## GOD HAS MERCY ON NINEVEH

*Jonah 1-4*

O LORD, . . . you are a gracious God and merciful, slow to anger and abounding in steadfast love. (Jonah 4:2)

### SUPPLIES:

(to make one craft)

- 1 sheet of white or pale-blue cardstock
- 1 sheet of copy paper
- templates of the great fish (the full page) and the small Jonah (see pages 104–5)
- crayons or markers
- scissors
- additional pink, red, black, or white copy paper
- glue
- goldfish-shaped crackers and/or fish stickers

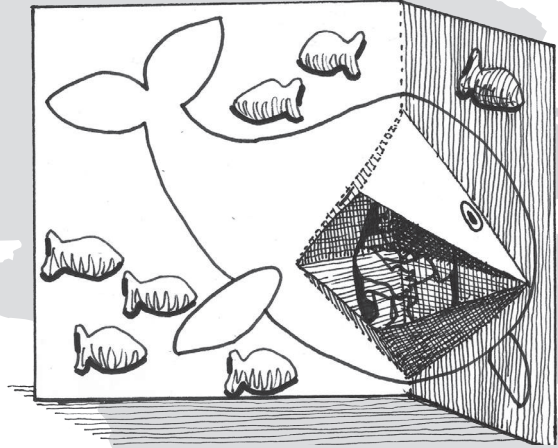

### INSTRUCTIONS:

**PREP STEP:** Copy the full-page template of the great fish onto cardstock. Copy Jonah onto copy paper.

1. Color Jonah and the great fish and cut out Jonah.
2. Fold the great-fish picture inward on the vertical dotted line, crease, and fold it back the other direction. Cut the slit that will form the mouth of the fish, cutting through both layers of paper. Fold on the diagonal line from the corner of the mouth to the crown of the head and crease. Fold on the dotted line from the corner of the mouth to the throat and crease. Fold both triangular flaps backward along the same lines and reverse the creases. Fold the fish picture inward again, this time arranging the various creases so that the great mouth opens and closes when the picture is folded and unfolded.
3. Glue the entire fish picture, excluding the panels that form the mouth, onto pink, red, black, or white paper. Glue Jonah inside the whale's mouth, creasing him where necessary.
4. Glue fish-shaped crackers and/or place fish stickers in the water around the great fish.
5. *Optional:* Cut out the illustrated verse and glue it to your craft.

**MAKE IT SIMPLE:** Cut and crease ahead of time and glue the fish picture to its backing sheet.

**MAKE IT AMAZING:** Use the great-fish picture as a template for tracing onto fish- or whale-textured craft paper. Fold, slit, and crease, then glue at least the head area, excluding the mouth panels, to black, red, or pink paper. Cut off the paper that extends past the outline of the fish. Add some googly eyes and attach Jonah using a hook-and-loop fastener such as Velcro® so that he is detachable. Next either glue the fish to a metallic, glitter, or other water-design paper background, or you can glue it to the back side of the same type of paper you used for the front side, then trim the edges to make a free-standing, double-sided fish that opens its mouth to reveal Jonah inside.

Jonah template

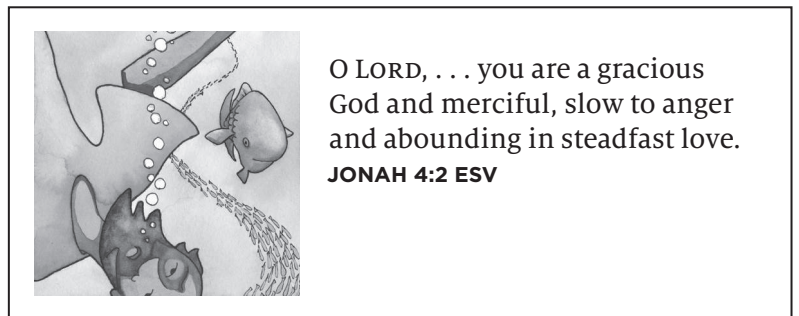

O LORD, . . . you are a gracious  
God and merciful, slow to anger  
and abounding in steadfast love.  
**JONAH 4:2 ESV**

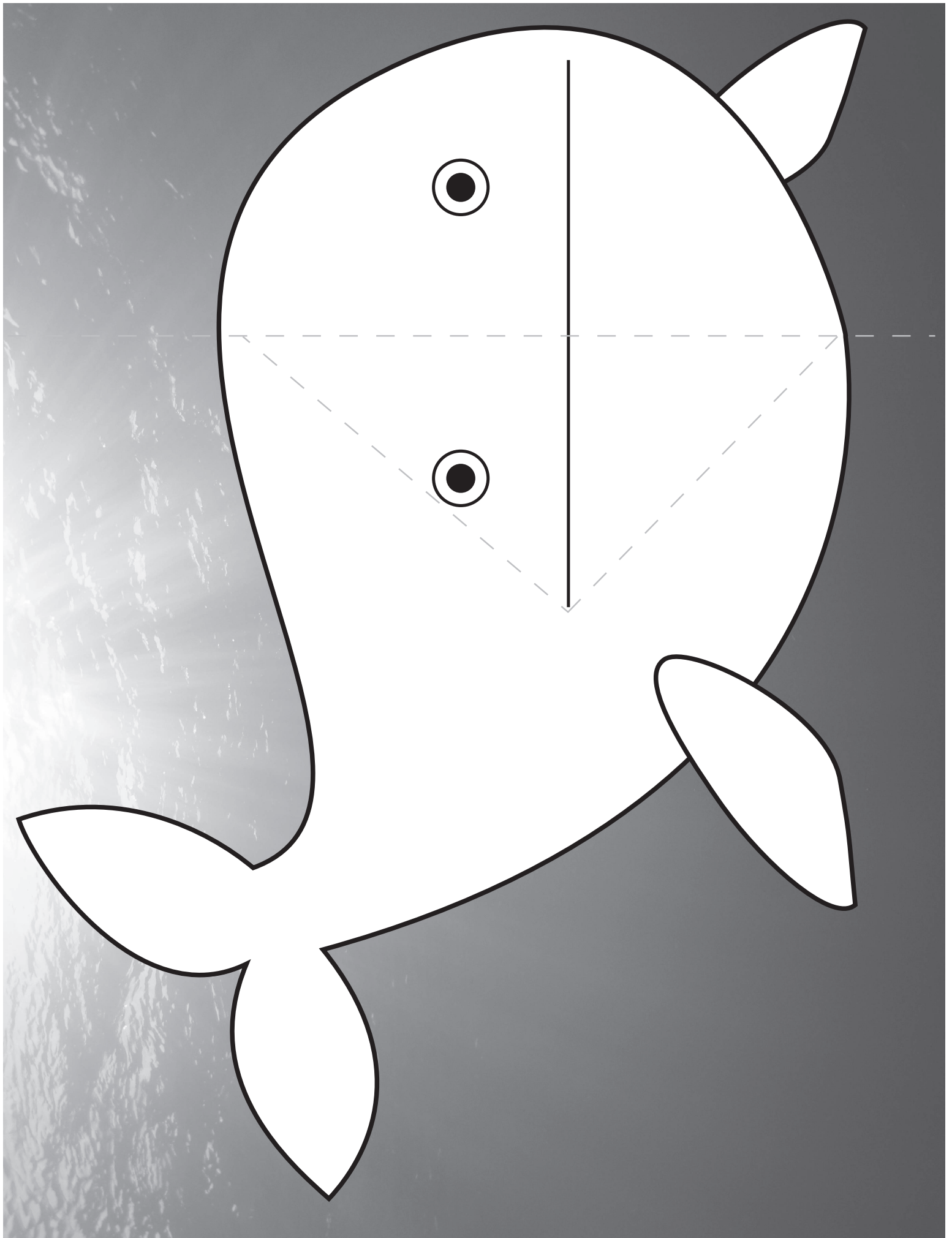



## GOD'S WORD IS FOUND

*2 Kings 22:1-23:27; 2 Chronicles 34:1-35:19*

I have stored up your word in my heart, that I might not sin against you. (Ps. 119:11)

### SUPPLIES:

(to make one craft)

- 1 sheet of white cardstock
- templates of King Josiah and the scroll (see page 107)
- crayons or markers
- scissors
- tape
- optional*: 1 sheet of copy paper

### INSTRUCTIONS:

**PREP STEP:** Copy the templates of Josiah and the scroll onto white cardstock. *Optional for Step 4:* Copy the illustrated verse.

1. Color the pictures of Josiah and the scroll and cut them out.
2. Fold the bottom half of the rectangle up behind Josiah so that the soles of his feet are behind him. Fold the now double-sided rectangle up to form a base for the kneeling king.

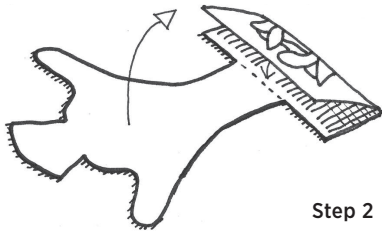

Step 2

3. Roll the scroll up tightly, starting at the end with the handles. Unroll just enough to reach from one of the king's hands to the other, allowing the hands to come forward a bit. Tape the scroll so that it cannot unroll any further, then tape it to Josiah's hands so that it looks like he is reading from it.

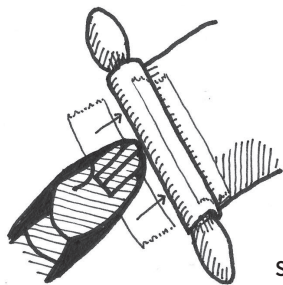

Step 3

4. *Optional:* Cut out the illustrated verse and paste it to King Josiah's back.

**MAKE IT SIMPLE:** Cut, roll, and fold ahead of time, securing the scroll in its partially rolled position.

**MAKE IT AMAZING:** Copy the Ten Commandments or instructions about keeping the Passover on the front and back of the scroll before rolling it up. King Josiah read the Law of Moses to the people, and held the first Passover celebration since the days of Samuel. Another option is to draw pictures about the Passover on the scroll.

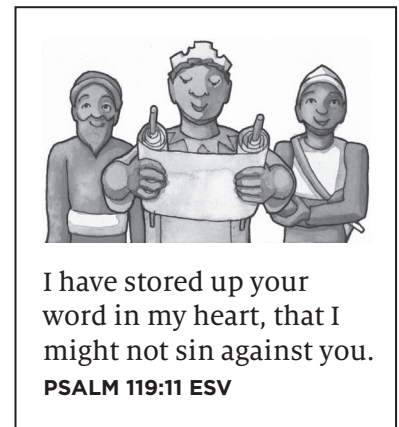

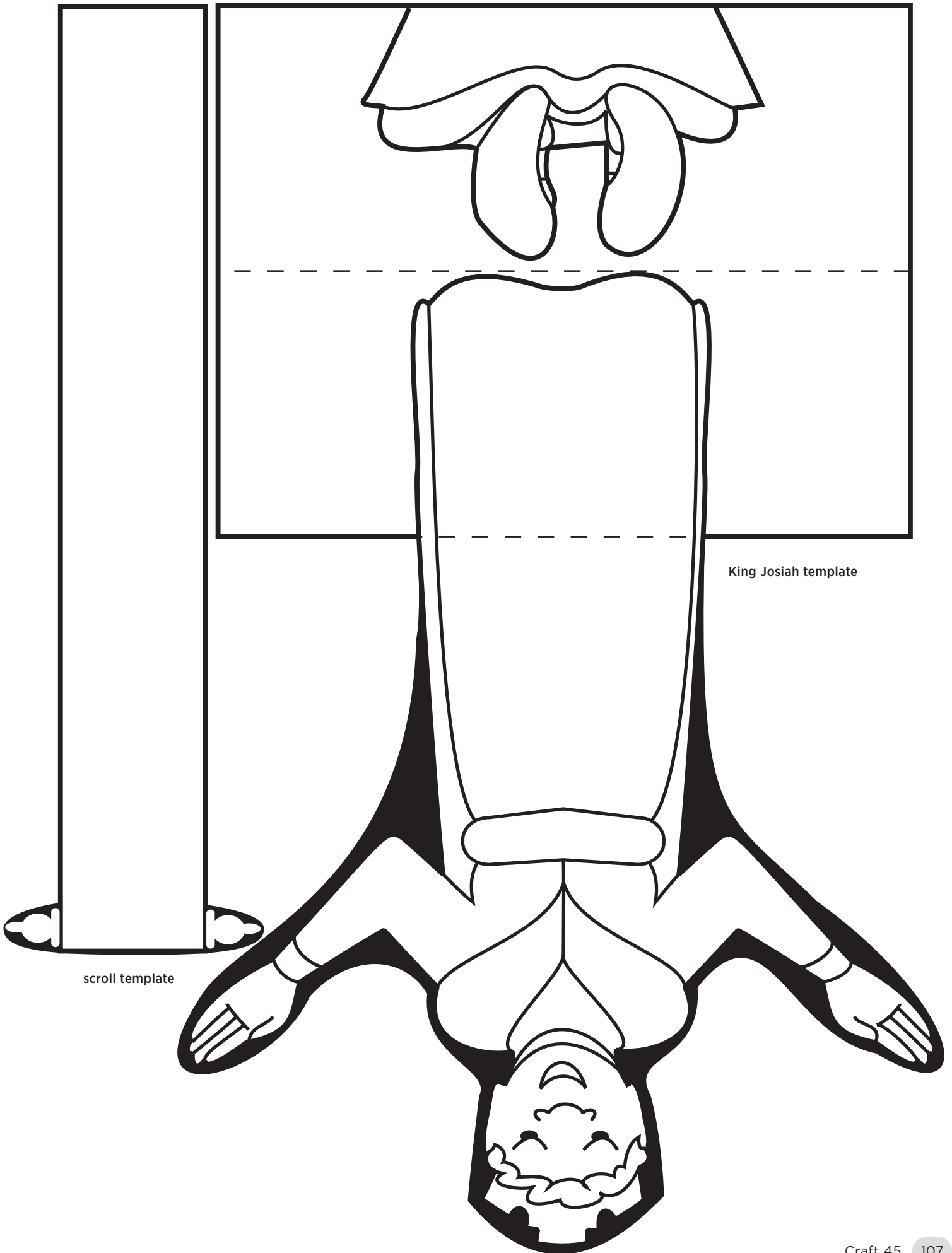

King Josiah template

scroll template

## GOD MAKES DRY BONES LIVE

*Ezekiel 37:1-14*

I will give you a new heart, and a new spirit I will put within you. (Ezek. 36:26)

### SUPPLIES:

- 1 sheet of white cardstock
- five-paneled template of bones gaining new life and single-panel template of dry bones (see page 109)
- crayons *or* markers
- scissors
- glue

### INSTRUCTIONS:

**PREP STEP:** Copy the five-panel and single-panel templates onto white cardstock.

1. Color the pictures and cut the two pieces out. Flip the five-paneled piece face down and fold the four outer flaps inward to cover the central rectangle, creasing well each time.
2. Unfold the flaps and paste the picture of the dry bones into the center.

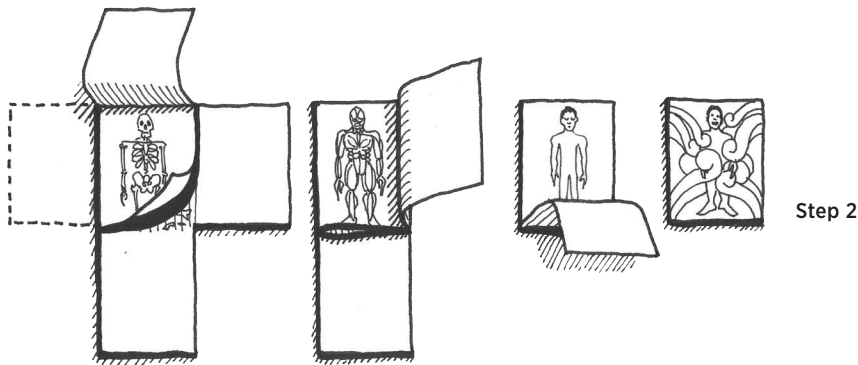

3. As you refold each flap starting on the left and continuing clockwise, watch the progression of God's actions as Ezekiel obediently prophesies.

**MAKE IT SIMPLE:** Cut and crease before class.

**MAKE IT AMAZING:** After you have colored everything, trace over the four winds with blue or white glitter glue.

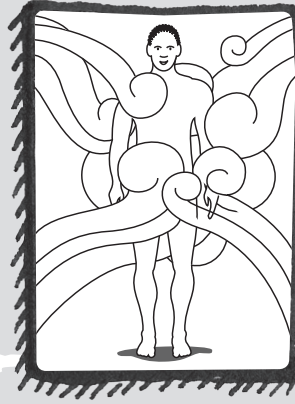

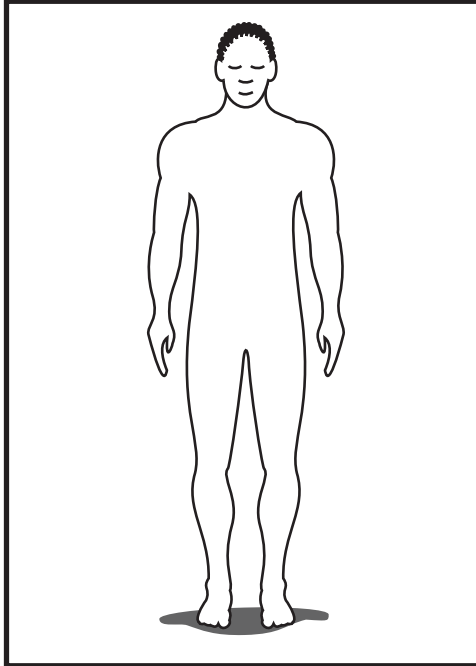
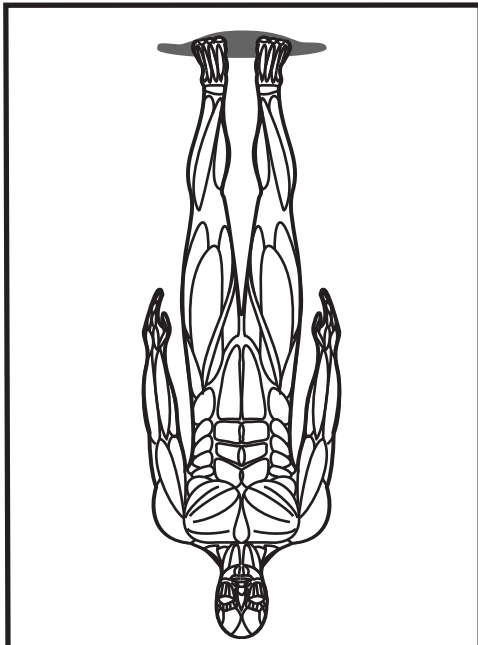
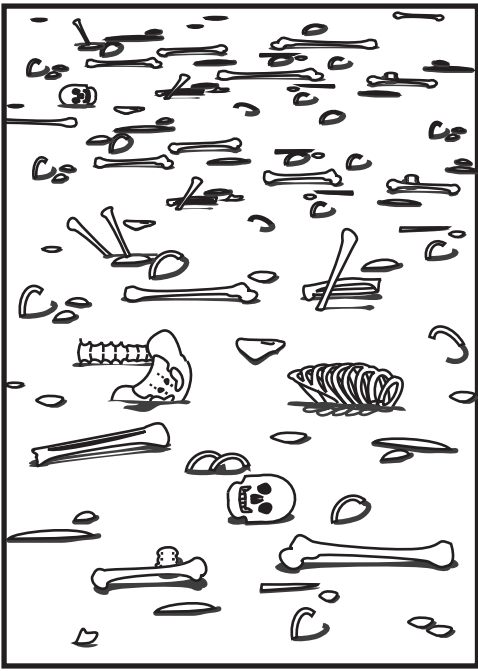

I will give you a new heart,  
and a new spirit  
I will put within you.  
EZEKIEL 36:26 ESV

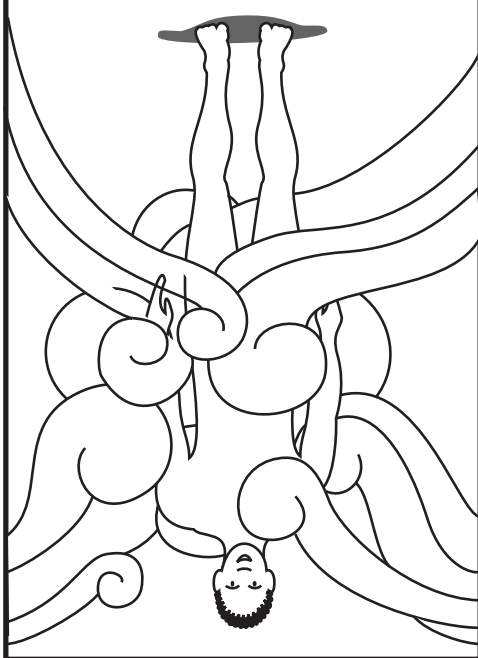
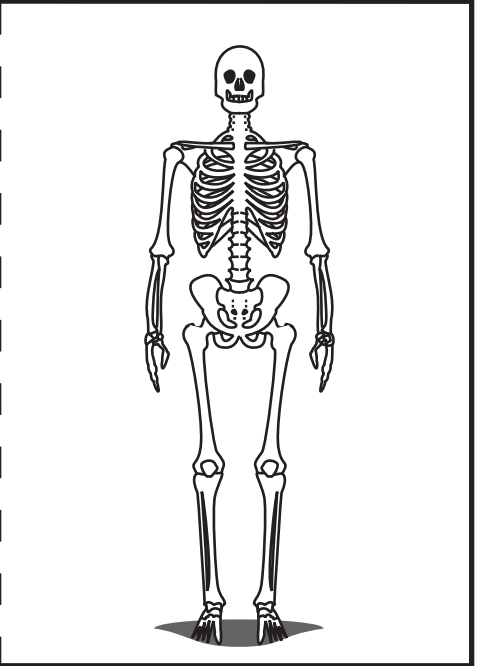

five panel template

## GOD IS WITH HIS PEOPLE IN EXILE

### Daniel 1

When a man's ways please the LORD, he makes even his enemies to be at peace with him. (Prov. 16:7)

#### SUPPLIES:

(to make one craft)

- 2 sheets of white copy paper
- templates of young man's half-silhouette, fruits, vegetables, drinking water, and scrolls (see page 111)
- tape
- adult-sized scissors
- optional*: backing sheet of any colored copy paper
- glue
- crayons or markers

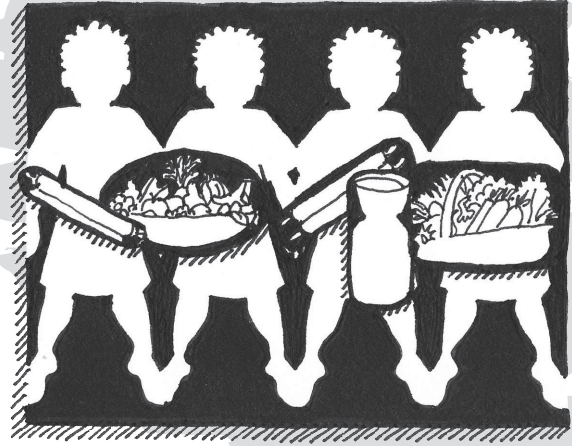

#### INSTRUCTIONS:

**PREP STEP:** Copy the silhouette, food, water, and scrolls templates onto white copy paper.

1. Create a paper-doll chain of Daniel, Shadrach, Meshach, and Abednego: Fold a piece of copy paper in half crosswise, then in half again in the same direction a second and third time. Be careful to align the corners and edges every time, so that you end up with a long, narrow rectangle where all eight layers are lined up squarely.
2. Cut out the silhouette rectangle template. Place it over your folded rectangle so that the center of the body on the template lines up with the long crease (unable to be opened). Make sure that the head is exactly on the edge, because your men will look wrong if their heads are too narrow or too wide. Tape the template in place if necessary, and use adult scissors to carefully cut out the white silhouette, cutting through all nine layers of paper at once.

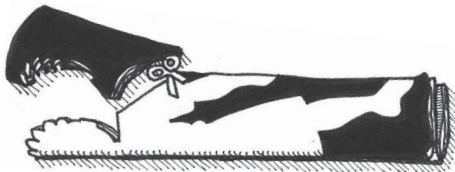

Step 2

3. Unfold the paper to reveal the four young men, and paste them to a colored sheet of backing paper if you wish. Use crayons or markers to give them faces and clothing.
4. Color and cut out the copies of the fruits, vegetables, water, and scrolls. Paste them into the friends' hands to show what they ate, drank, and studied in the Babylonian palace.
5. *Optional*: Cut out the illustrated verse and paste it to your craft.

**MAKE IT SIMPLE:** Cut out the paper-doll chains ahead of time, but let the students unfold them.

**MAKE IT AMAZING:** Use the dolls as a template to trace and cut out tunics for them from stiffened felt. Cut and glue pictures of fruit and vegetables from supermarket advertisements.





drinking water template

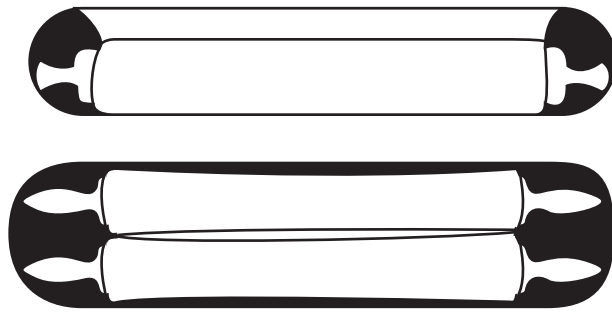

scroll templates



fruit template

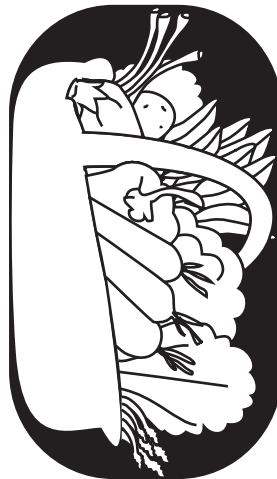

vegetable template



When a man's ways please the LORD, he makes even his enemies to be at peace with him. **PROVERBS 16:7 ESV**



Place this edge against crease.

young man silhouette template

## GOD DELIVERS SHADRACH, MESHACH, AND ABEDNEGO

*Daniel 3*

If sinners entice you, do not consent. (Prov. 1:10)

### SUPPLIES:

(to make one craft)

- 1 paper lunch sack
- crayons or markers
- scissors
- 1 sheet of white copy paper
- template of four men (see page 113)
- tape
- yellow, orange, and red tissue paper

### INSTRUCTIONS:

**PREP STEP:** Copy the template of the four men onto white copy paper.

1. Fold the top inch of the paper lunch sack outward and down twice, as if folding down a turtleneck or the cuff of a sock. This will keep the bag “furnace” open and sturdy.
2. Draw a 3-inch square “door” on the front of the bag and cut it on three sides, being careful not to cut through the back of the bag. Pull the door open and crease the fourth side.
3. Color the four men and cut them out along the edges of the rectangle. Slip their picture into the back of the furnace so that it can be seen through the door, and tape it in place.
4. Cut 6-inch squares of tissue paper, two each of yellow, orange, and red. Pinch each square an inch below its center and pull all the corners and edges away from the pinch, to make tufts of “flames.” Set one or two tufts in the bottom of the furnace so that the tips of the flames show through the doorway, and tape them in place. Arrange the remaining tufts with their pinched bases just inside the folded rim of the furnace and tape them in place.
5. *Optional:* Cut out the illustrated verse and tape it to the back of the furnace.

**MAKE IT SIMPLE:** Construct the furnaces and cut the squares of tissue paper before class.

**MAKE IT AMAZING:** Draw, paint, or stamp bricks on the outside of the furnace.

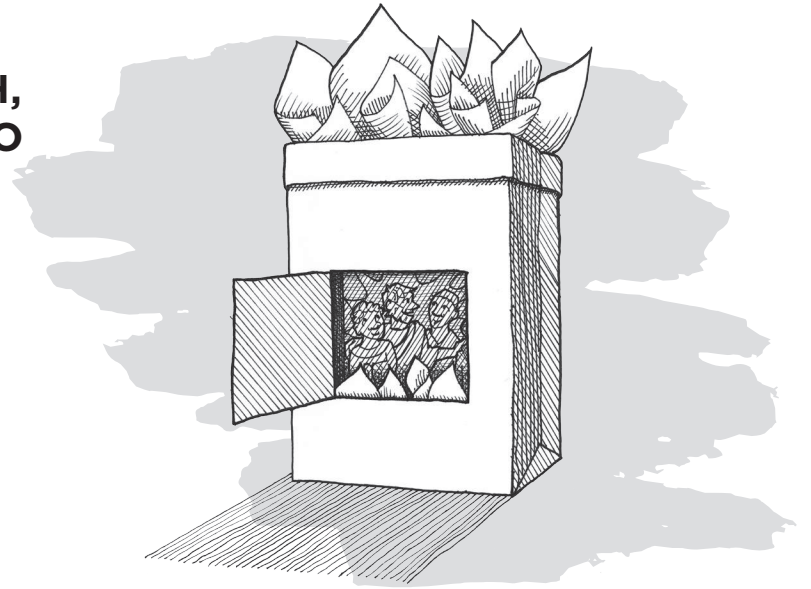



If sinners entice you, do not consent.

**PROVERBS 1:10 ESV**

## GOD HUMBLER NEBUCHADNEZZAR

*Daniel 4*

Those who walk in pride [God] is able to humble.  
(Dan. 4:37)

### SUPPLIES:

(to make one craft)

- 2 sheets of white cardstock or copy paper
- optional*: black cardstock or paper
- templates of Nebuchadnezzar's body parts in silhouette (see pages 114–15)
- scissors and *optional* craft knife such as X-Acto™
- 5 brass fasteners, preferably black

### INSTRUCTIONS:

**PREP STEP:** Copy the templates of the body parts onto white cardstock.

1. Cut out the body parts. Slit the lines inside the tiny ⊗ with a craft knife or scissors so that the brass fasteners will pass through multiple layers.
2. Assemble King Nebuchadnezzar: Use a brass fastener to secure the crown (which becomes long hair) to his head with the face in front and the crown behind. Fasten his neck and both shoulders to the top of his torso with a single fastener. Attach the large ends of both thighs to his lower torso with a single fastener. Finally, attach each lower leg at the knees.
3. When Nebuchadnezzar is proud, place him in a standing position with the crown on his head. When God fulfills his word against the king, place Nebuchadnezzar in a crawling position with one hand on the ground to support his weight and one feeding himself grass. Swivel the crown down to look like long hair. When God restores Nebuchadnezzar, place him in a kneeling position, bowed slightly and raising a hand in prayer. The crown can be swiveled up or down at that point.
4. *Optional*: Cut out the illustrated verse and paste it to the king's torso.

**MAKE IT SIMPLE:** Cut and slit all the shapes ahead of time, stacking and cutting several pages at once. Construct the king together as a class, one step at a time, then practice putting him in the three positions together.

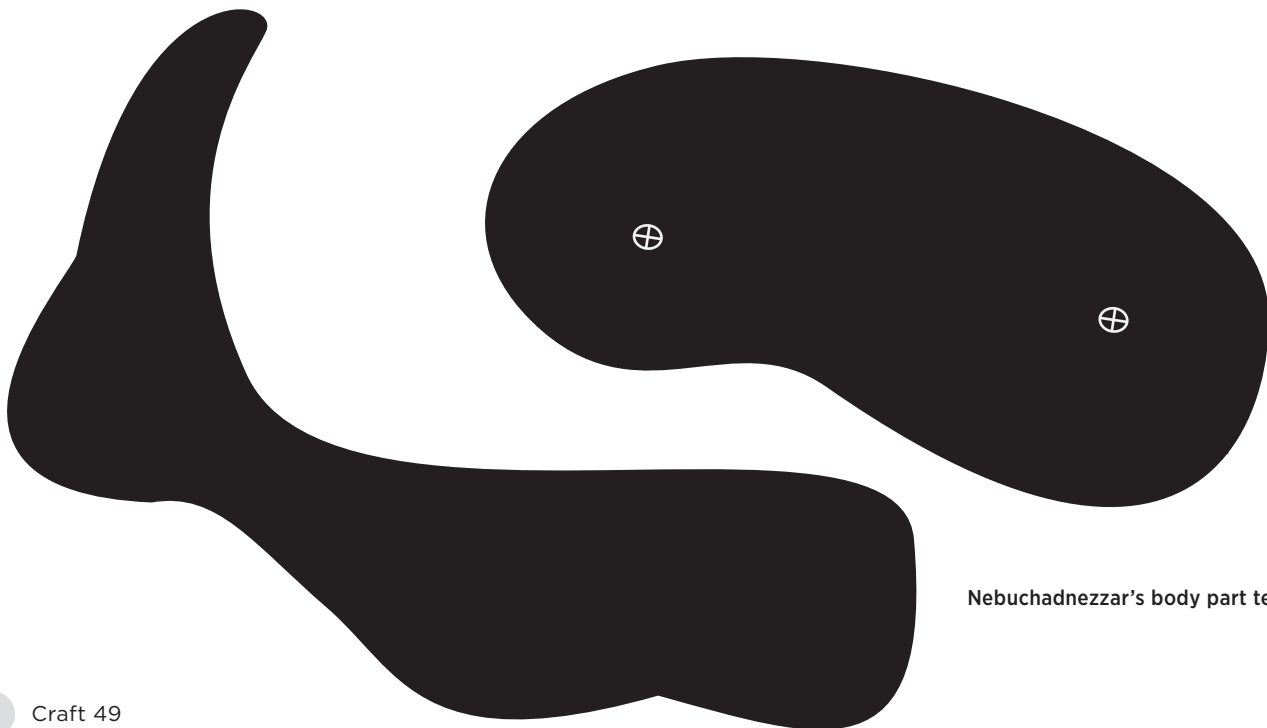

Nebuchadnezzar's body part templates

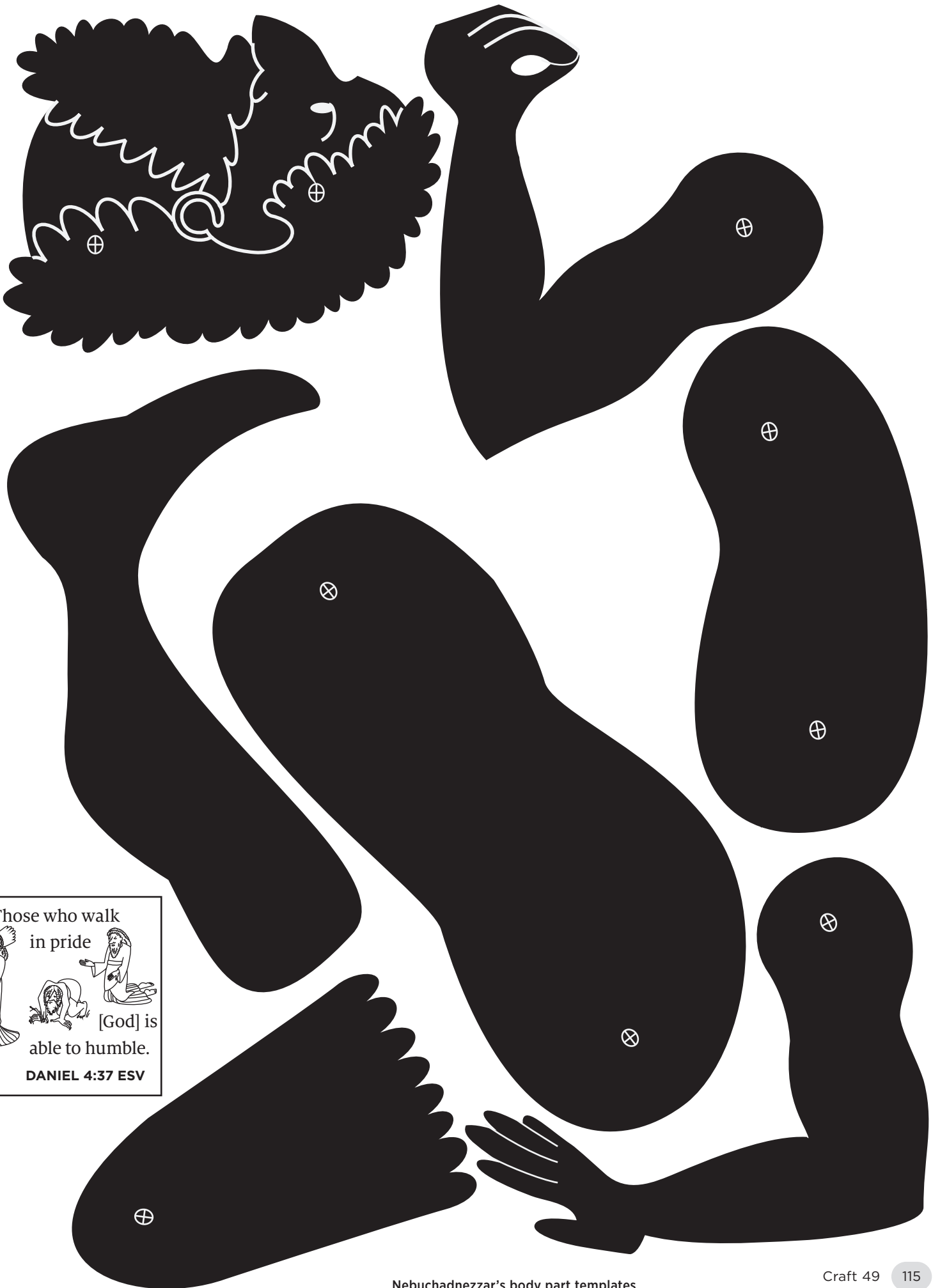

Those who walk  
in pride  
[God] is  
able to humble.  
**DANIEL 4:37 ESV**

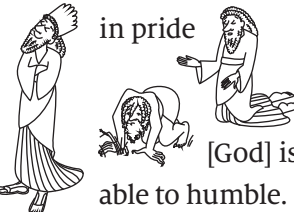
A small black and white illustration within the text box. On the left, a man wearing a crown and a long robe stands with his hand to his chin. On the right, a man in a long robe kneels on the ground, gesturing towards the standing man. In the center, between the two figures, is a small illustration of a lion.



# GOD WRITES ON THE WALL

## Daniel 5

The Most High God rules the kingdom of mankind.  
(Dan. 5:21)

### SUPPLIES:

(to make one craft)

- 1 sheet of white cardstock
- templates of Belshazzar's feast and the writing-hand wheel (see page 117)
- scissors and *optional* craft knife such as X-Acto™
- 1 brass fastener
- crayons or markers

### INSTRUCTIONS:

**PREP STEP:** Copy the templates onto white cardstock.

1. Color the images and cut them out, including the rectangle in the wall.
2. Push a brass fastener through the ⊗ symbol in the feast scene, then through the center of the wheel placed behind the scene. You may need to slit the cardstock inside the circle before the fastener will pass through it. Turn the revealed edge of the wheel to turn it clockwise to see a hand appear on the wall and “write” the words that frightened King Belshazzar causing him to summon Daniel.



Step 2

3. *Optional:* Cut out the illustrated verse and paste on the back of your craft.

**MAKE IT SIMPLE:** Cut out everything, including the wall rectangle and small slits, ahead of time.

**MAKE IT AMAZING:** Use gold and silver metallic paints or paint markers to color the temple vessels spread before the king.

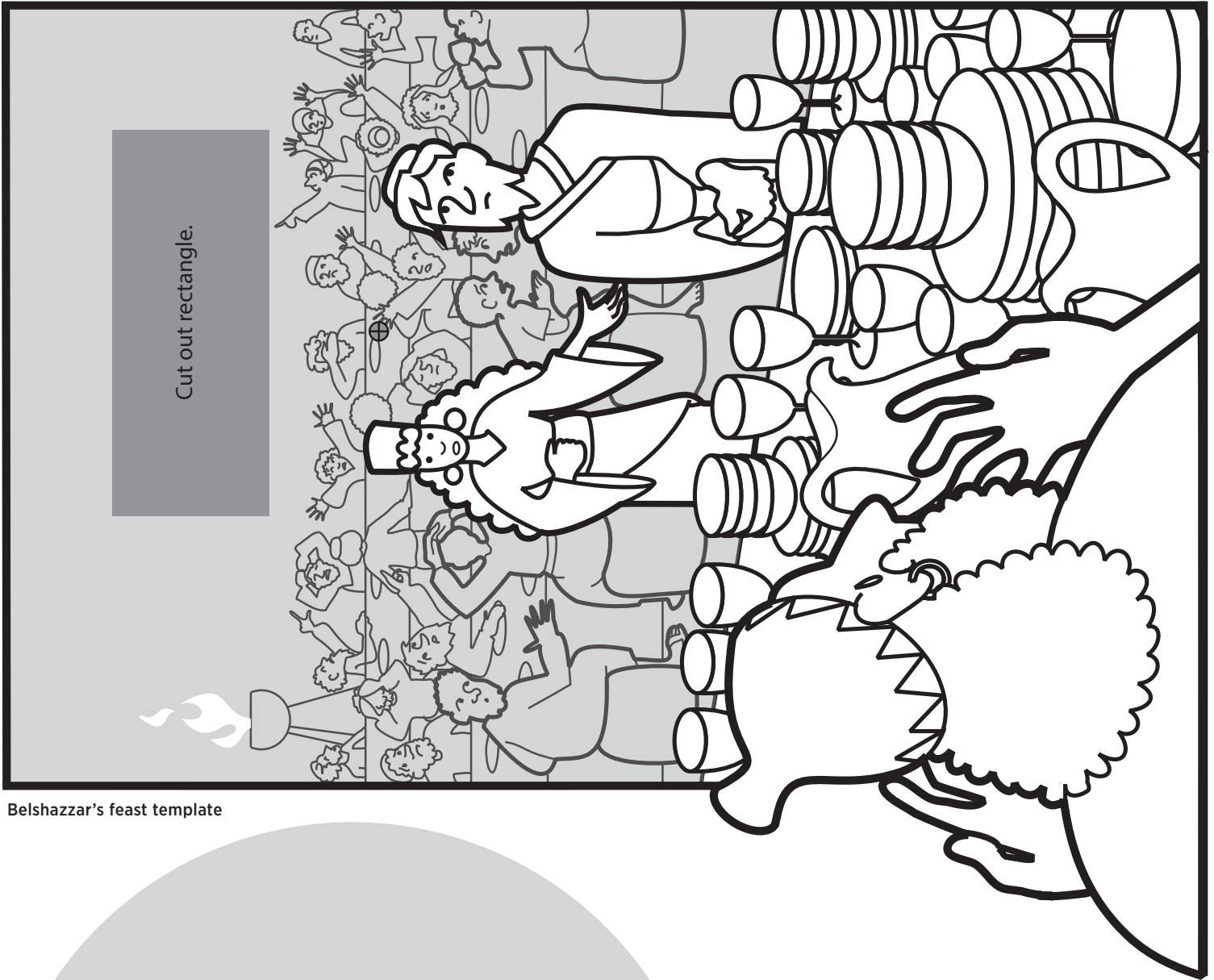

Belshazzar's feast template

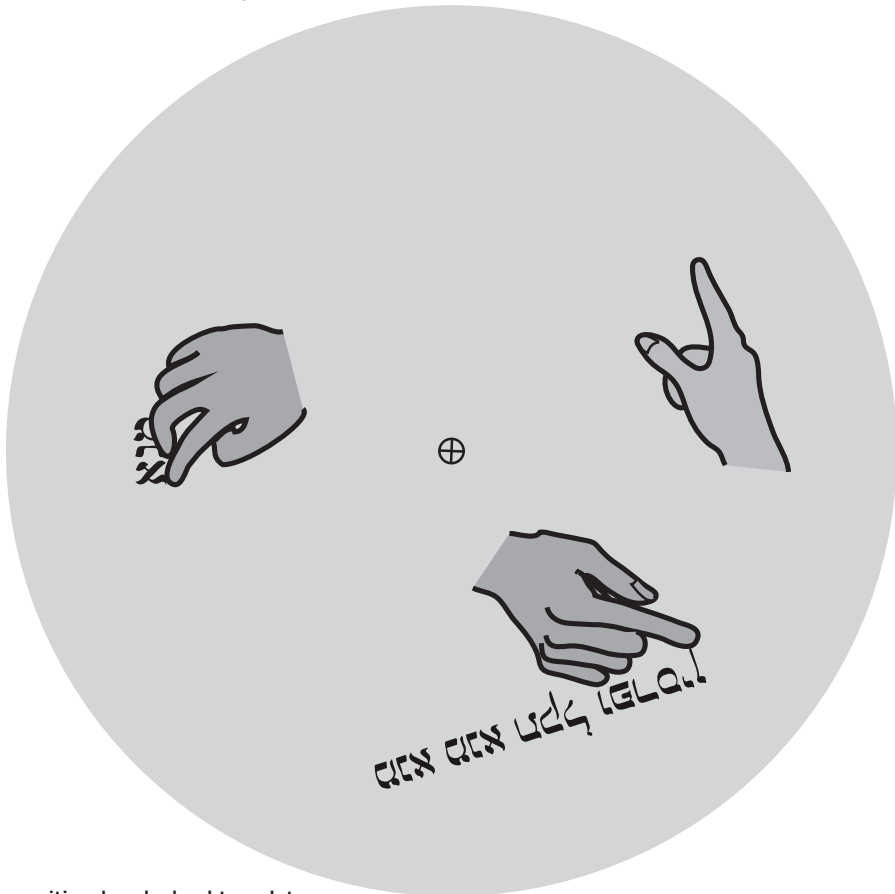

writing-hand wheel template



The Most High God rules the kingdom of mankind. **DANIEL 5:21 ESV**

## GOD PROTECTS DANIEL FROM LIONS

### Daniel 6

[God] delivers and rescues . . . he who has saved Daniel from the power of the lions. (Dan. 6:27)

#### SUPPLIES:

(to make one craft)

- ❑ 2 sheets of white cardstock
- ❑ templates of the muzzle and Daniel with a lion (see pages 119–20)
- ❑ crayons or markers
- ❑ scissors and *optional* craft knife such as X-Acto™
- ❑ glue and/or tape

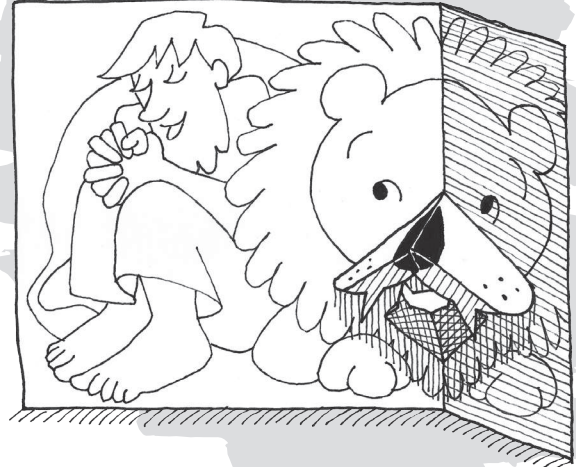

#### INSTRUCTIONS:

**PREP STEP:** Copy the muzzle and Daniel-with-lion templates onto white cardstock.

1. Color the picture of Daniel and the lion. Color the muzzle and cut it out on the solid lines.
2. Fold the right half of the lion's face back along the vertical dotted line and crease. Cut his lower jawline and tooth along the solid line, cutting through both layers of cardstock. Fold the jaw down along the diagonal dotted line, crease well, and unfold. Now reverse the crease down the lion's face by bringing the right side forward. Pull the lower jaw down and reverse its crease so that it pops out.

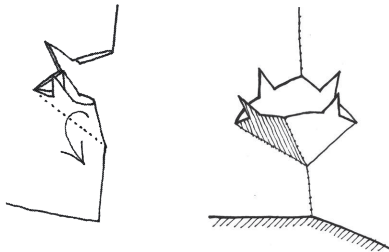

Step 2

3. Fold back the tabs and the teeth and lips on the dotted lines of the muzzle. Fold the muzzle in half on the center dotted line so that the big black nose is on the outside. Use glue and/or tape to attach the muzzle tabs to the corresponding tab shapes on the lion's face. The center crease of the muzzle should be aligned exactly with the center crease of the lion's face. Now the lion's mouth will open and close as you fold and unfold the drawing.
4. *Optional:* Cut out the illustrated verse and paste it to the back of the picture.

**MAKE IT SIMPLE:** Make all cuts and creases before class.

**MAKE IT AMAZING:** Glue 1-inch pieces of lion-colored yarn all around the mane.

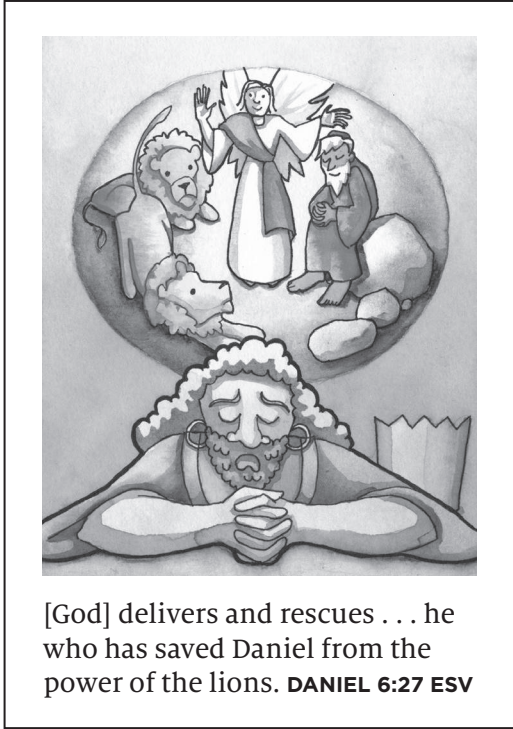

[God] delivers and rescues . . . he who has saved Daniel from the power of the lions. **DANIEL 6:27 ESV**

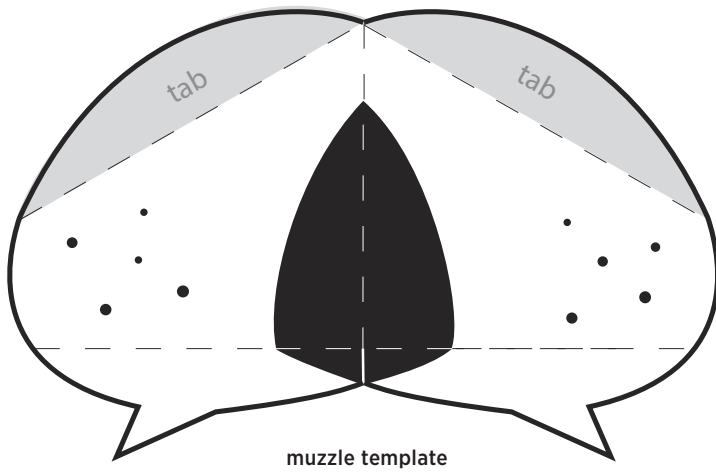

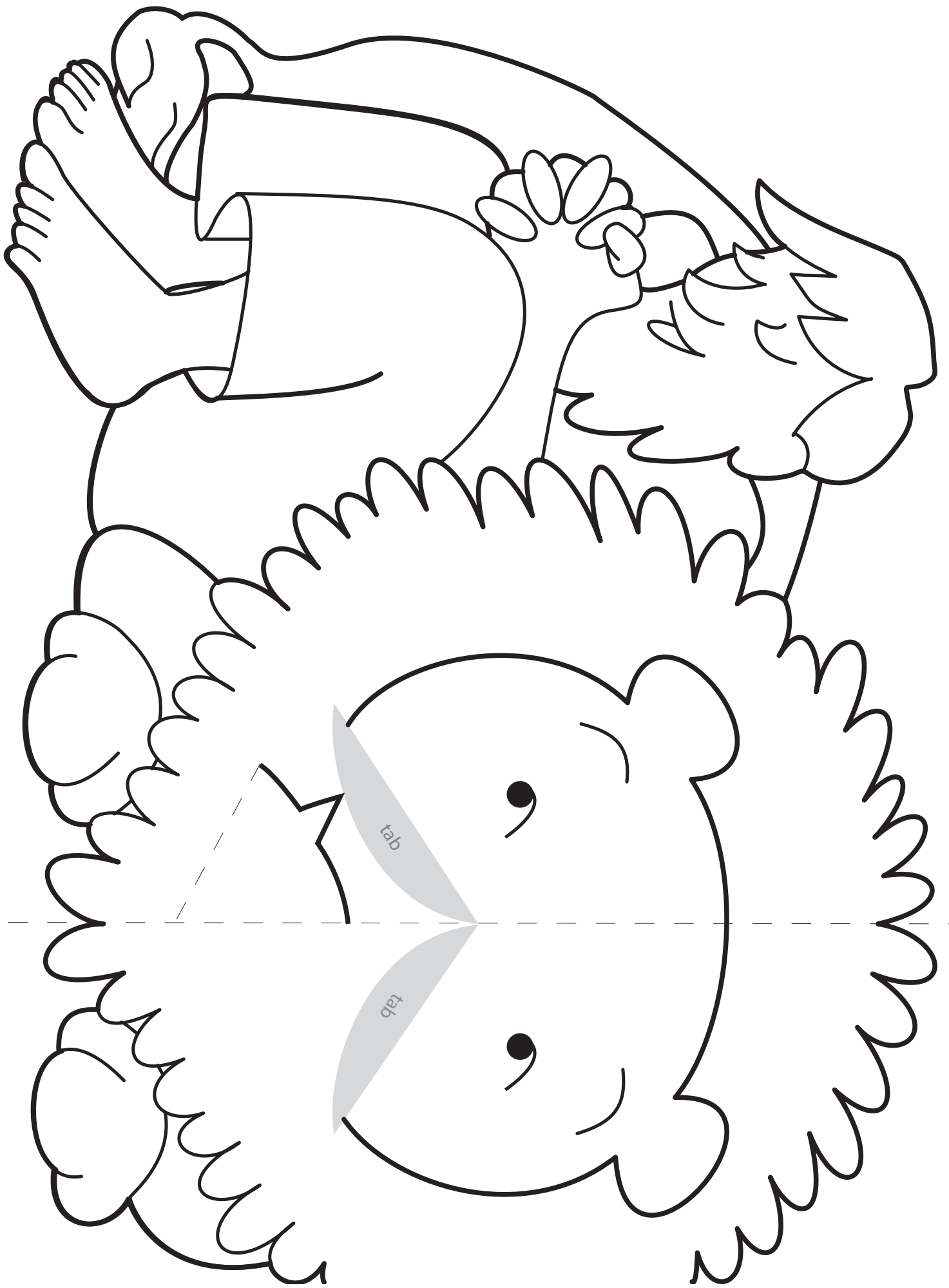



## GOD CHOOSES ESTHER TO BE QUEEN

*Esther 1:1-3:6*

The Lord knows how to rescue the godly from trials.  
(2 Pet. 2:9)

### SUPPLIES:

(to make one craft)

- 1 sheet of white card stock
- templates of 4 finger puppets (see below)
- crayons or markers
- scissors
- tape

### INSTRUCTIONS:

**PREP STEP:** Copy the finger-puppet templates onto white cardstock.

1. Color the finger puppets and cut them out.
2. Curl the side tabs back, overlapping them to form thick rings with  $\frac{3}{4}$ -inch diameters, and tape them in place.
3. *Optional:* Cut out the illustrated verse and glue it to the back of one of the puppets.

**MAKE IT SIMPLE:** Cut out the puppets ahead of time, but keep them flat to color.

**MAKE IT AMAZING:** Use glitter glue and scraps of fabric, colored papers, and notions to decorate the puppets and their headpieces. Use them to tell the story of Esther.

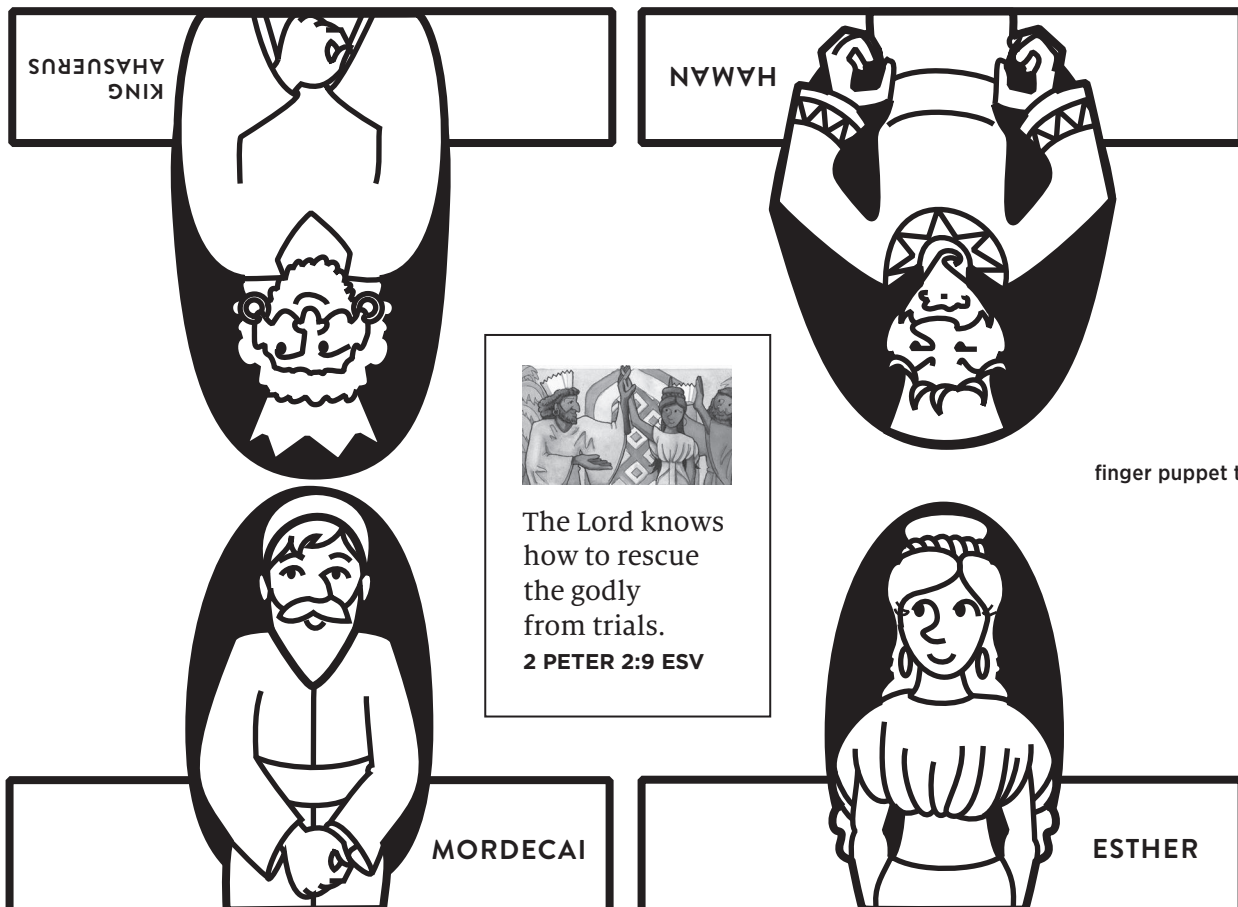

## GOD DELIVERS HIS PEOPLE

*Esther 3:7-7:10*

Be strong and courageous. Do not be frightened, and do not be dismayed, for the LORD your God is with you wherever you go. (Josh. 1:9)

### SUPPLIES:

(to make one craft)

- 2 sheets of metallic or colored paper
- tape
- 1 sheet of white cardstock
- template of star-shaped scepter end (see page 123)
- crayons or markers
- scissors

### INSTRUCTIONS:

**PREP STEP:** Copy the double-star-shaped template onto white cardstock.

1. Tightly roll a sheet of metallic or any colored paper lengthwise to form the rod of a scepter and then tape it closed.

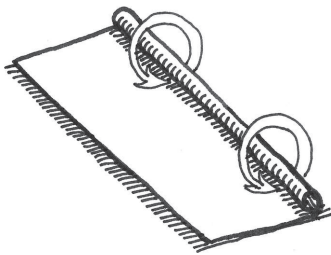

Step 1

2. Color the double-star-shape, cut it out, and fold it on the dotted line. Open it, position the top inch of the rod inside (rod pointing down, star pointing up), and tape it in place. Close the star and secure it with more tape.

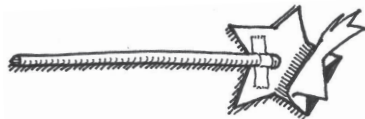

Step 2

3. Cut a 4 x 4-inch square from metallic or any colored paper. Fold it in half and, cutting through the crease up to a point half an inch from the opposite edge, cut parallel slits in the paper as shown.
4. Unfold the paper and wrap it around the rod of the scepter with the slits running vertically. Tape the top solid edge just below the star and the bottom solid edge close enough that the strips of paper between the top and bottom edges bow outward all around.



Steps 3 and 4

**MAKE IT SIMPLE:** Roll and tape the rods, cut out the double stars, and slit the squares before class. If you are pressed for time, omit Steps 3 and 4.

**MAKE IT AMAZING:** Decorate further with markers, ribbon, sequins, or jewel stickers.

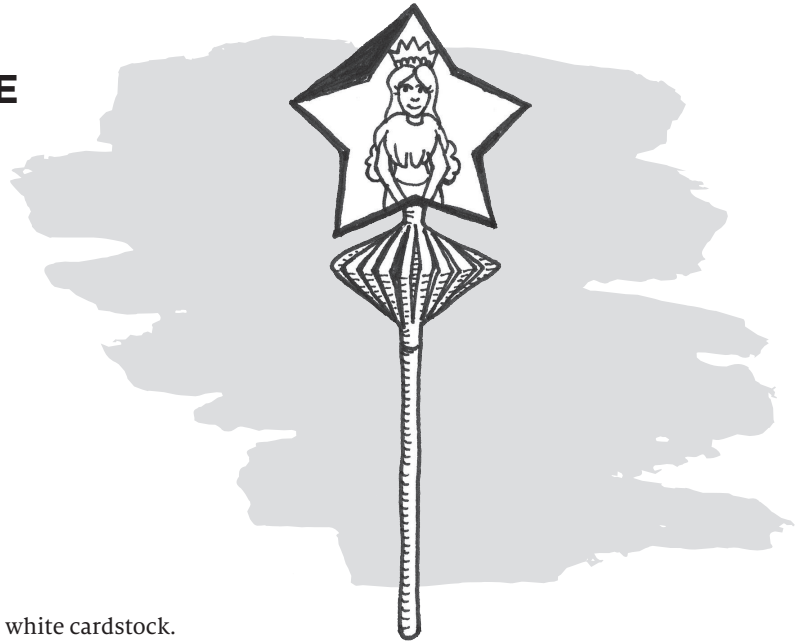

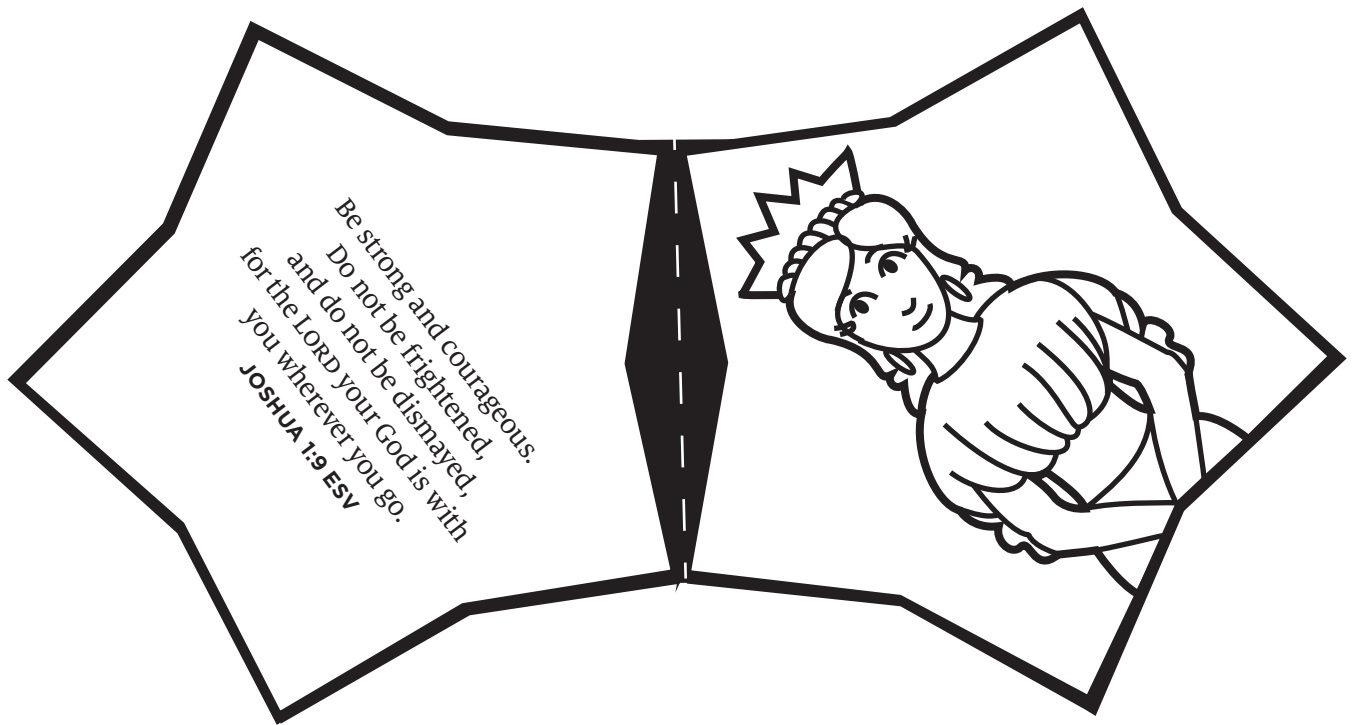

star-shaped scepter template

## GOD BLESSES ZECHARIAH AND ELIZABETH

*Luke 1:5–25, 39–45, 57–80*

Blessed be the Lord God of Israel, for he has visited and redeemed his people. (Luke 1:68)

### SUPPLIES:

- 1 sheet of white cardstock
- templates of Zechariah and Elizabeth, baby John, writing tablet, and large oval (see page 125)
- crayons *or* markers
- scissors
- 1 sheet of colored cardstock
- 8-inch ribbon (curling ribbon is fine)
- glue

### INSTRUCTIONS:

**PREP STEP:** Copy the Zechariah and Elizabeth, baby John, and tablet templates onto white cardstock.

1. Color Zechariah and Elizabeth, baby John, and the tablet and cut them out.
2. Cut a slightly larger oval from colored cardstock, using the template if you wish.
3. Glue both ends of an 8-inch length of ribbon to the back of the ornament (Zechariah and Elizabeth) to form a hanger. Glue the ornament onto the larger oval so that the picture is centered and the ends of the ribbon are sandwiched between the papers.
4. Glue baby John into Elizabeth's arms and the tablet into Zechariah's.
5. *Optional:* Cut out the illustrated verse and glue it to the back of your ornament with your name and the year.

**MAKE IT SIMPLE:** Cut everything out and glue the ribbon hangers in place before class.

**MAKE IT AMAZING:** Make the tablet and baby stand out from the ornament using a layer of foam or corrugated cardboard. If desired, glue a layer of foam or cardboard between the two ovals as well. Glue pieces of cotton ball onto Elizabeth's hair and Zechariah's eyebrows, mustache, and beard.

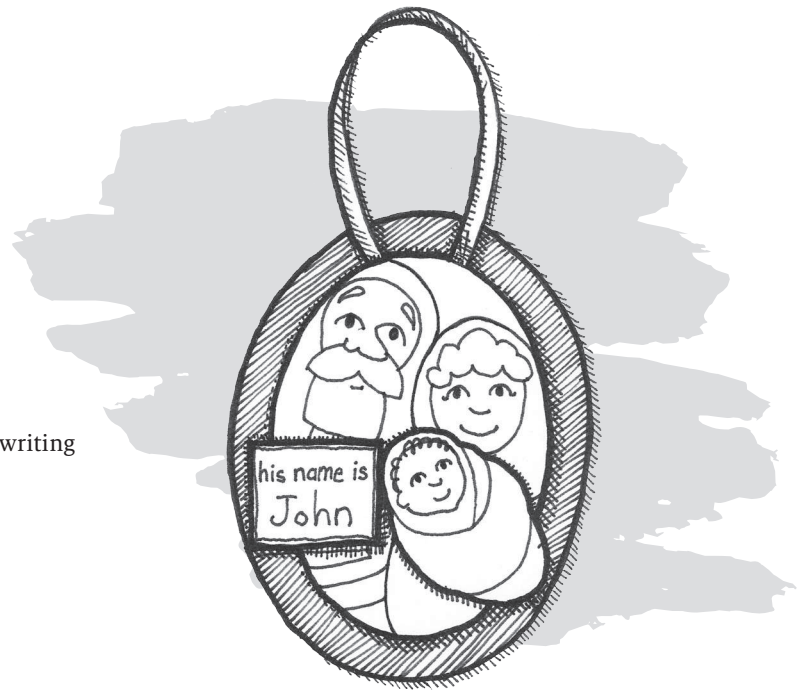

large oval template

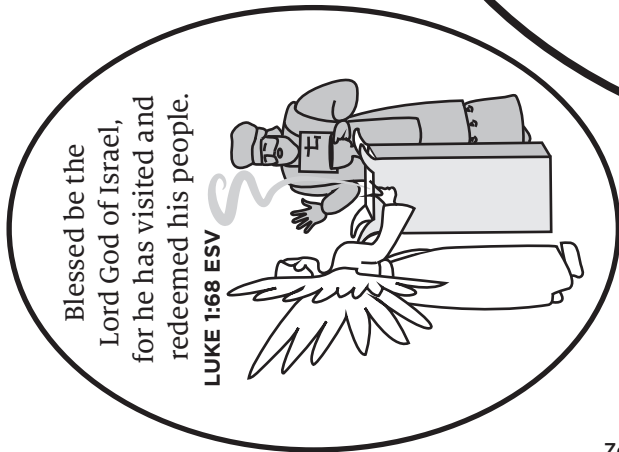
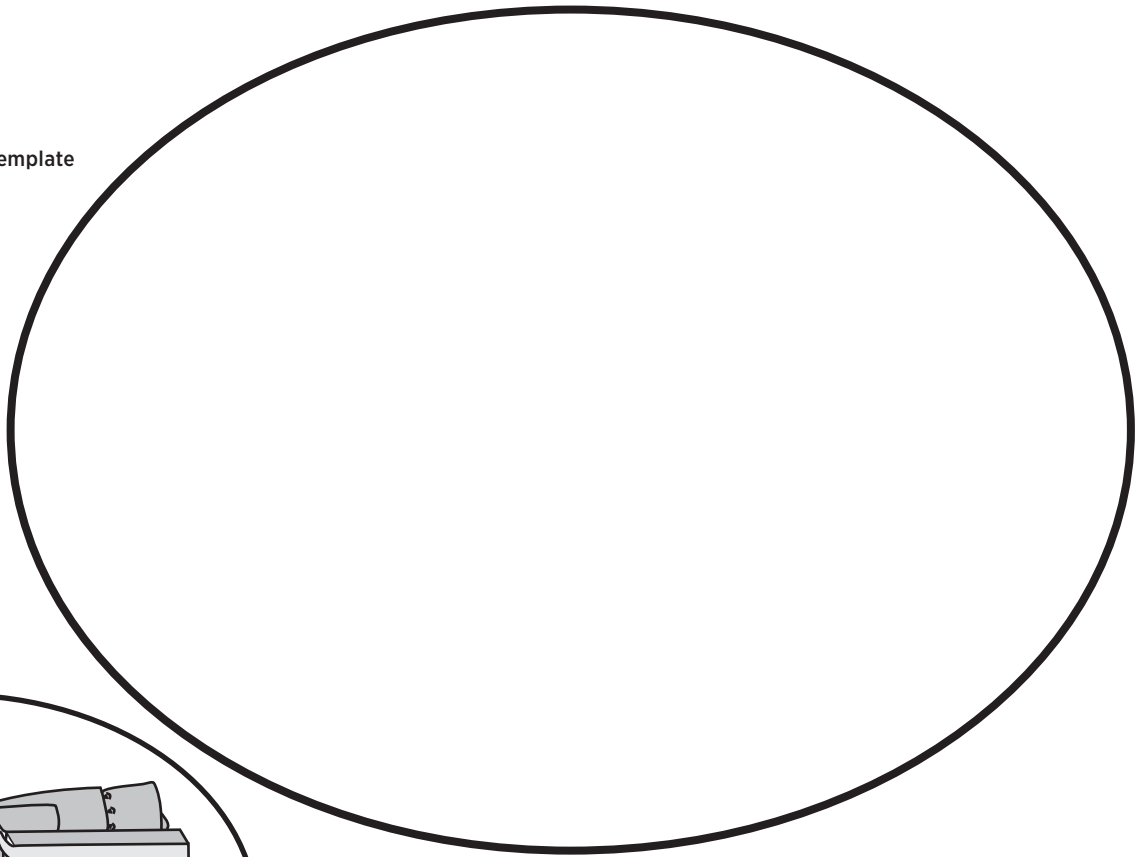

Zechariah and Elizabeth template

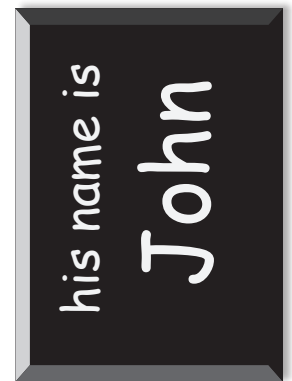

writing tablet template

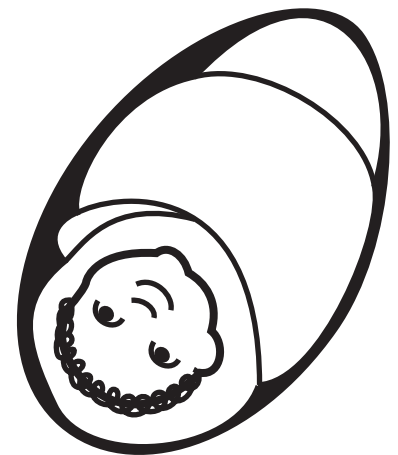
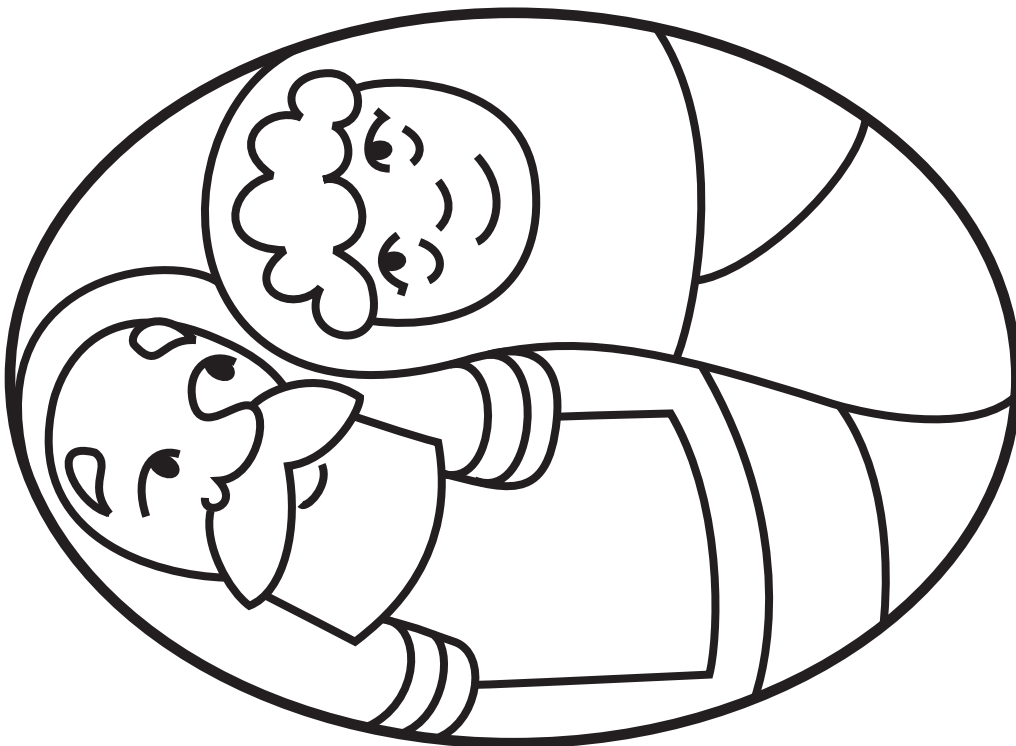

baby John template



## GOD REVEALS HIS PLAN TO MARY AND JOSEPH

*Matthew 1:18–25; Luke 1:26–56*

You shall call his name Jesus, for he will save his people from their sins. (Matt. 1:21)

### SUPPLIES:

(to make one craft)

- a 6 x 4 ½-inch sheet of decorative paper
- 1 sheet of coordinating solid-colored cardstock
- a pen or pencil
- scissors
- 1 sheet of white copy paper
- templates of angel robe and sleeves, head, and hands (see page 127)
- tape and/or glue
- skin-colored craft foam or paper
- black marker
- a 10-inch ribbon or cord
- clear packing tape



### INSTRUCTIONS:

**PREP STEP:** Copy the templates onto white copy paper.

1. Fold a sheet of solid-colored cardstock in half, place your hand on it with fingers spread, and trace around it. Cut it out through both layers at once.
2. Cut the robe and sleeve shapes from a 6 x 4 ½-inch rectangle of decorative paper (with or without using the template provided). Tape or glue the sleeves in place behind the robe and cut off the small ends that stick out past the robe.

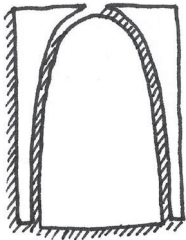

Step 2

3. Place the head and hands templates over skin-colored craft foam or paper and cut them out. Use a black marker to draw a face and hair on the head. Glue or tape the head with its chin and jaw overlapping the top of the robe. Glue or tape one hand, thumb up, to the end of its corresponding sleeve.
4. Spread your hand shapes behind the angel to look like open wings, and glue or tape them in place. Use packing tape to attach the ends of a 10-inch length of ribbon to the back of the angel's head or shoulders to form a hanger.

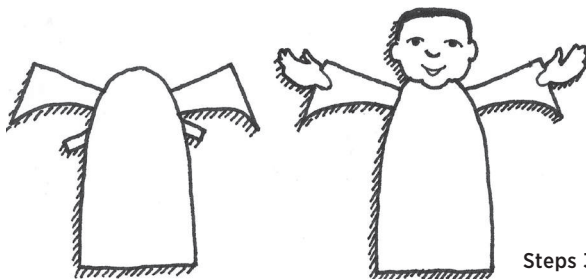

Steps 3 and 4

5. *Optional:* Cut out and glue the illustrated verse onto the back of the angel's robe with your name and the year.

**MAKE IT SIMPLE:** Trace and label the students' hands as they enter the class, then have an assistant cut them out during story time. Cut out and assemble the robes ahead of time, or, if students are able to cut well enough, have rectangles cut to size with the robe shapes drawn on the backs, ready to be cut. Cut out the heads and hands ahead of time and allow students to draw faces, but be prepared to redraw them yourself on the reverse sides if students are unhappy with their own drawings.

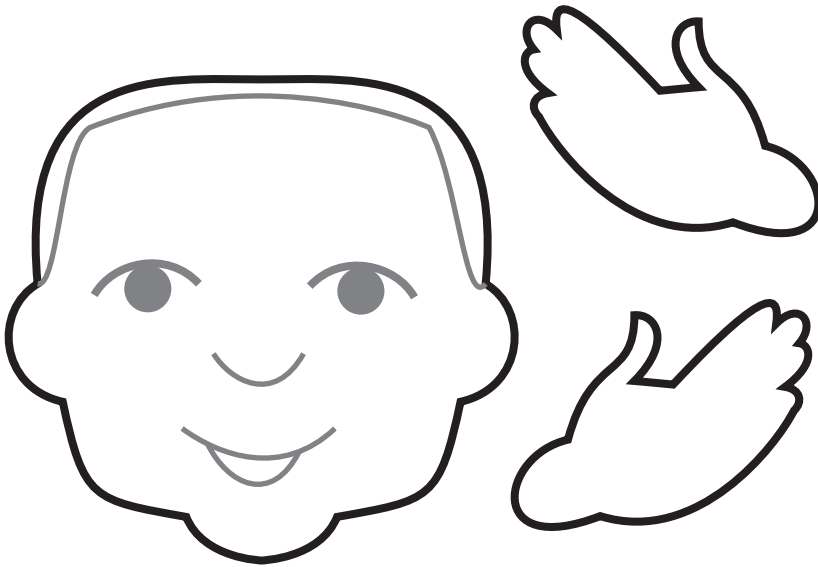

angel head and hands template

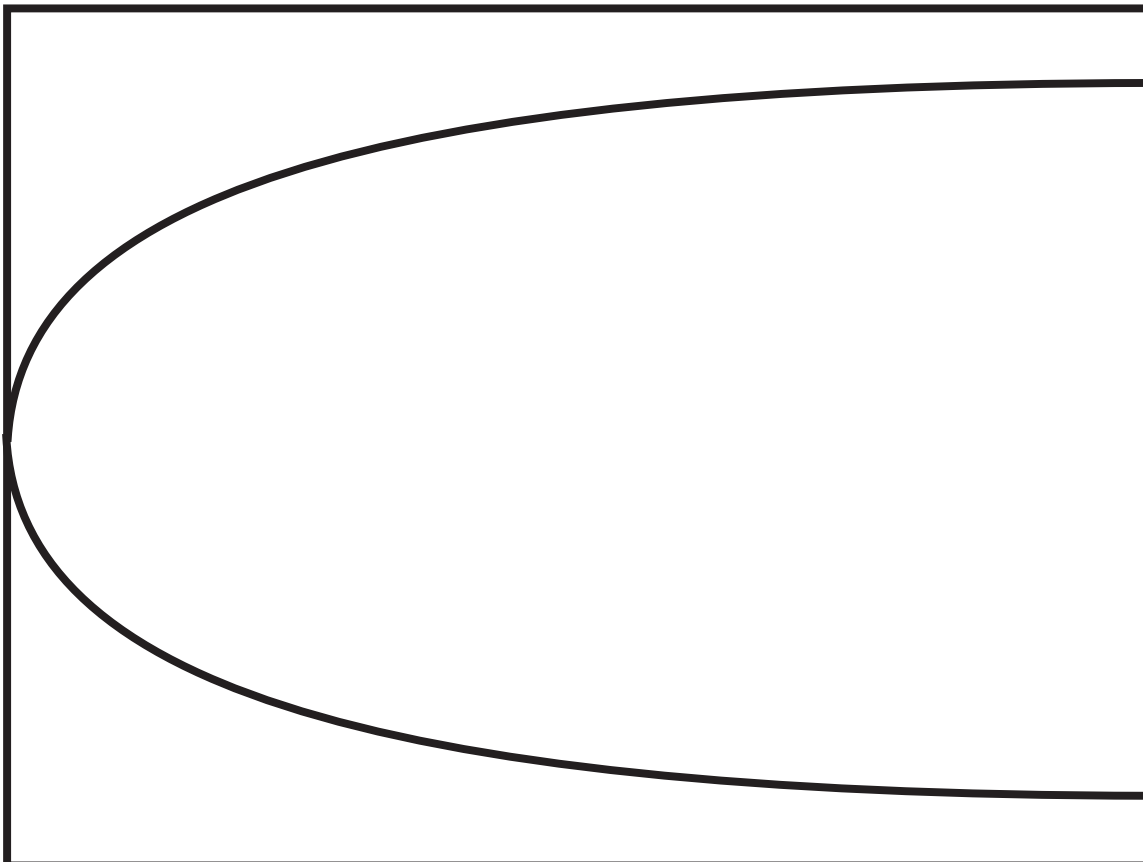
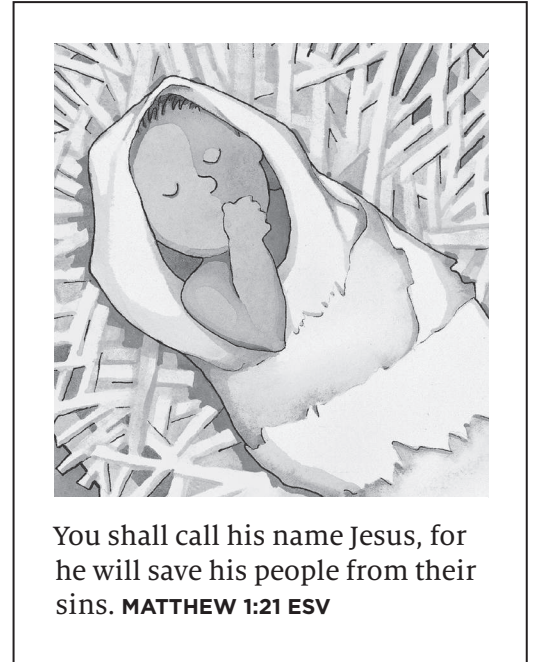

angel robe and sleeves template

## GOD'S SON IS BORN

*Luke 2:1-7*

Behold, the virgin shall conceive and bear a son, and they shall call his name Immanuel. (Matt. 1:23)

### SUPPLIES:

(to make one craft)

- 1 sheet of brown cardstock or paper
- template of manger (see page 129)
- glue and/or hot-glue gun or stapler
- 4 feet of natural raffia
- scissors
- 1 black marker
- 1 narrow strip of any white fabric (cotton, felt, terrycloth, etc.)
- 10–12 inches of ribbon (can be curling ribbon)
- 2- to 3-inch wooden peg doll or small wooden craft spoon or wooden bead and black chenille stem and cotton ball

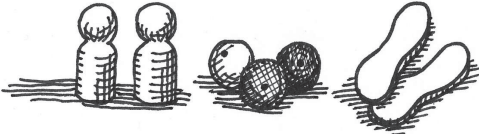

example of doll supplies needed

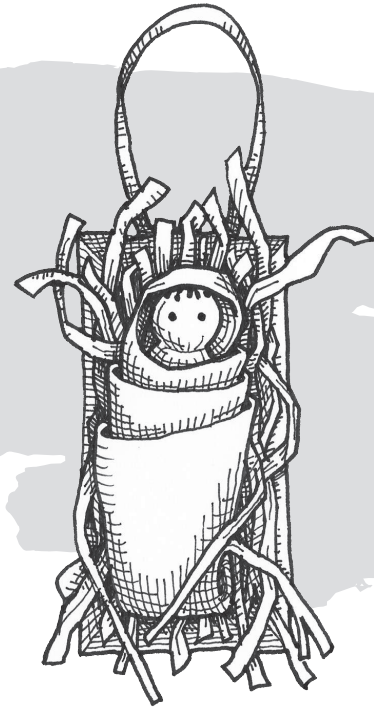

### INSTRUCTIONS:

**PREP STEP:** Copy the template of the manger onto brown cardstock or white copy paper to use as a pattern.

1. Cut out the manger image from brown cardstock or use the manger pattern to cut a manger box from a double thickness of brown paper. Fold the sides inward 90 degrees, align the edges, and glue the flaps to the inside or outside of the long manger walls. Hot glue (with an adult) or staple a 10- to 12-inch length of ribbon to the back so that the manger hangs in "portrait" orientation.

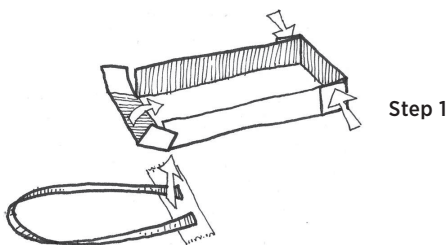

Step 1

2. Unravel and twist open about 3 feet of natural raffia. Use your thumb to pinch one end against your four straight fingers, and wrap the raffia around your fingers again and again until you have wrapped the entire 3 feet. Slip the bundle off your fingers and use another strand of raffia to tie the bundle securely around the middle. Cut through all the loops at both ends of the tied bundle. Glue or staple the bundle of raffia straw onto the manger. Glue on additional bits of raffia to fill in empty spots.

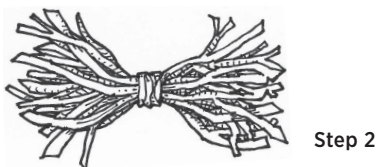

Step 2

- Use a black marker to make eyes on the peg doll, spoon, or bead. Draw hair on the peg doll or spoon. *If you are using a bead*, thread a black chenille stem through the hole in the bead, leaving about an inch at the top. Coil the bit at the top to look like short baby hair, and kink the stem just under the bead so that the bead cannot slip down the stem. Wrap the rest of the chenille stem that is below the kink around a cotton ball.



Step 3

- Wrap a strip of white cloth around the peg, spoon, or cotton-ball body so that it looks like a baby wrapped in swaddling cloths with the face uncovered. Glue or hot glue the baby into the manger of straw with his head at the hanger end.
- Optional:* Cut out the illustrated verse and glue it to the back of the ornament with your name and the year.

**MAKE IT SIMPLE:** Have mangers at least cut and creased if not glued together before class, as well as bundles of raffia ready to go into the mangers. Have strips of cloth ready and, if your students are young, draw the eyes on the babies ahead of time. If time is short, fringe a 4 x 6-inch piece of yellow construction paper all the way around to use in place of raffia.

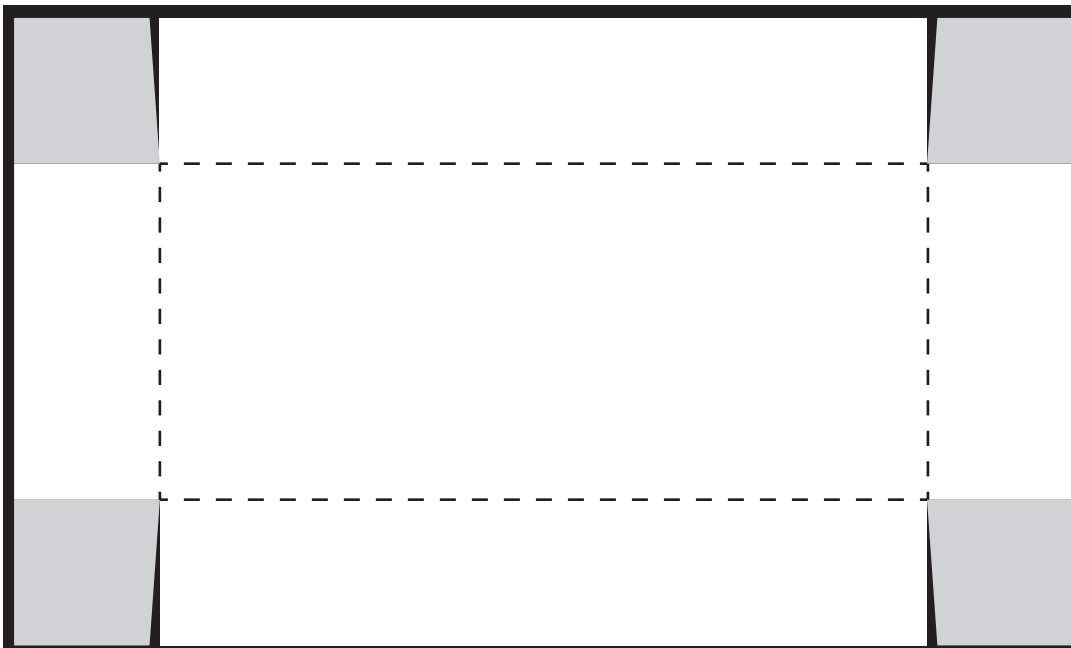

manger template



Behold, the virgin shall conceive and bear a son, and they shall call his name Immanuel.  
**MATTHEW 1:23 ESV**

## GOD ANNOUNCES THE SAVIOR'S BIRTH

*Luke 2:8-20*

Glory to God in the highest, and on earth peace among those with whom he is pleased! (Luke 2:14)

### SUPPLIES:

(to make one craft)

- 1 sheet of white stiffened felt or white cardstock
- optional:* 1 sheet of copy paper
- template of lamb without legs (see page 131)
- scissors
- optional:* hole punch
- 12 inches of ribbon (can be curling ribbon)
- 2 wooden clothespins
- markers
- 8–10 cotton balls
- glue

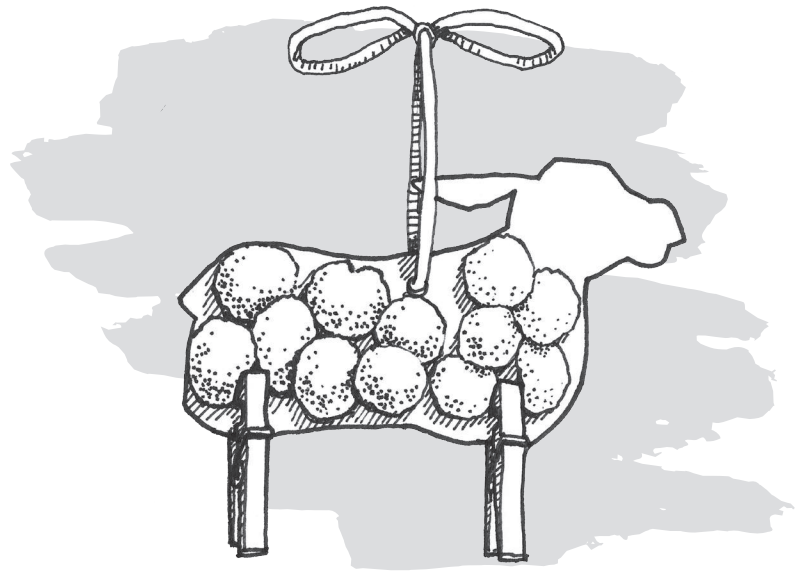

### INSTRUCTIONS:

**PREP STEP:** Copy the template of the lamb body onto white paper to make a pattern (or cardstock if you're not using felt).

1. Cut out the paper lamb pattern. Then lay the paper pattern onto the stiffened felt and, holding it securely in place, cut out a felt lamb (using cardstock instead of the felt is fine too). Use a hole punch or scissors to make a hole where indicated on the template.
2. Thread about 12 inches of thin ribbon through the hole and knot it to form a hanger loop, with or without a bow.
3. Clip two clothespins onto the lamb torso to become its front and back legs. Use markers to write your name and the year on a clothespin.
4. *Optional:* Cut out the illustrated verse and paste it to one side of the lamb.
5. Glue cotton balls to one or both sides of the lamb, being careful not to cover the verse (if included). You may need to pull the cotton balls into smaller pieces to better fit the shape of your lamb. Wait until the glue is dry to lift your lamb ornament. Use markers to decorate further if you wish.

**MAKE IT SIMPLE:** Cut out the lamb shapes before class, including their holes, and cut the ribbon to 12-inch lengths.

**MAKE IT AMAZING:** Paint the clothespins white to match the lamb's face. Thread a ribbon through a craft bell or jingle bell and tie it around the lamb's neck. Finish the lamb's face by drawing an eye and mouth with a fine-tipped black or brown felt marker.





Glory to God in the highest, and  
on earth peace among those with  
whom he is pleased!

**LUKE 2:14 ESV**

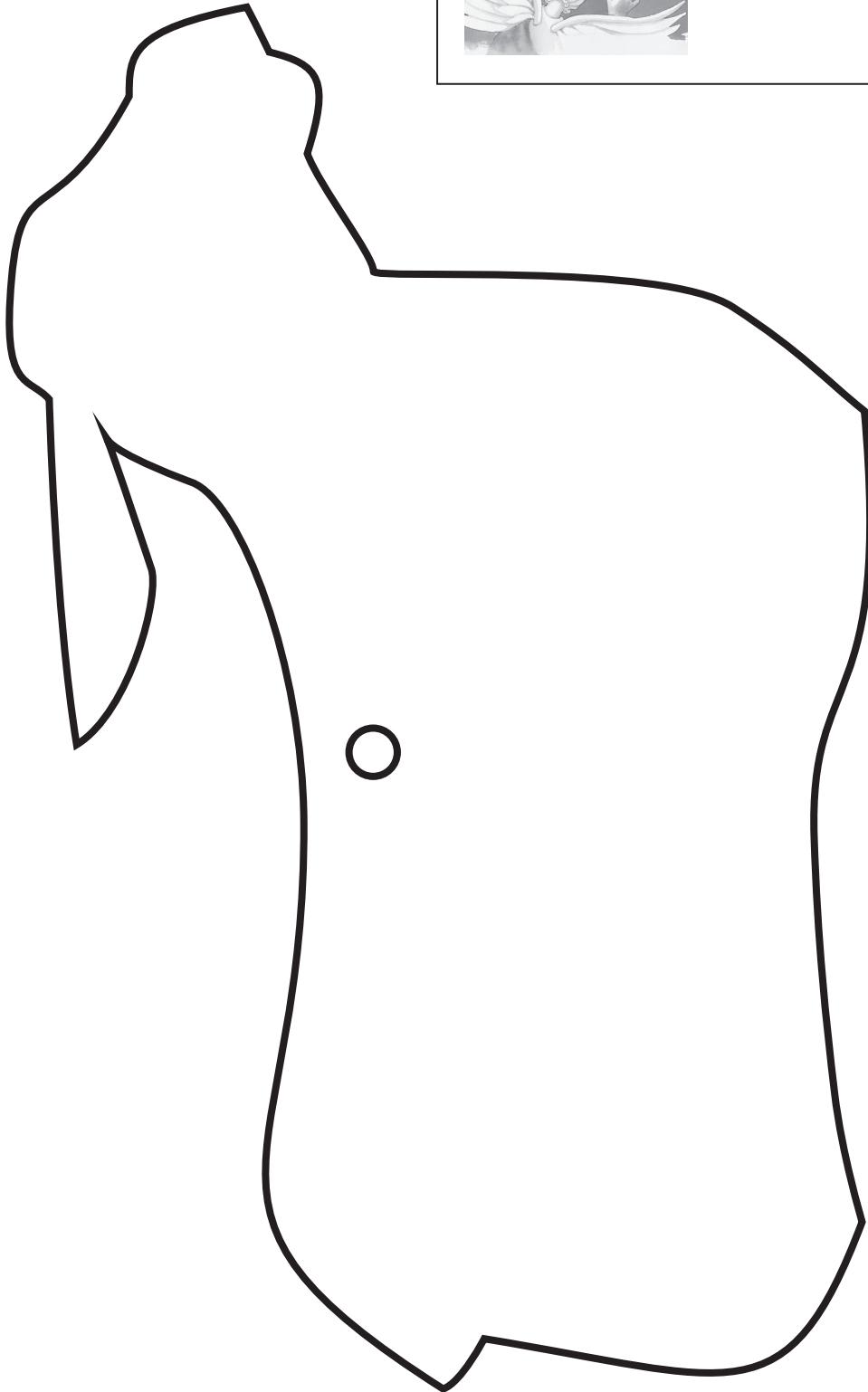

lamb template

## GOD IS GLORIFIED BY SIMEON AND ANNA

Luke 2:22–38

My eyes have seen your salvation that you have prepared in the presence of all peoples. (Luke 2:30–31)

### SUPPLIES:

(to make one craft)

- 1 sheet of white cardstock
- templates of the temple that opens, Simeon, Anna, and Jesus's family (see page 133)
- crayons or markers
- scissors
- glue
- optional:* ribbon (such as curling ribbon)
- optional:* 1 sheet of copy paper

### INSTRUCTIONS:

**PREP STEP:** Copy the temple and people templates onto white cardstock. *Optional for Step 5:* Copy the illustrated verse.

1. Color the temple, Simeon, Anna, and Jesus's family and cut them out. (The temple should remain one large rectangle.)
2. Place the temple piece face down, then fold its left and right sides in to meet each other, so that they form a complete picture of the temple, and then crease on the dotted lines.
3. Open the temple and paste in Jesus and his parents on their eighth-day visit, then paste in Simeon and Anna thanking God for Jesus.
4. *Optional:* Glue a ribbon hanger to the back to make this a Christmas ornament and write your name and the year on the back.
5. *Optional:* Cut out the illustrated verse and glue it on the back, perhaps covering the ribbon ends.

**MAKE IT SIMPLE:** Cut and crease ahead of time.

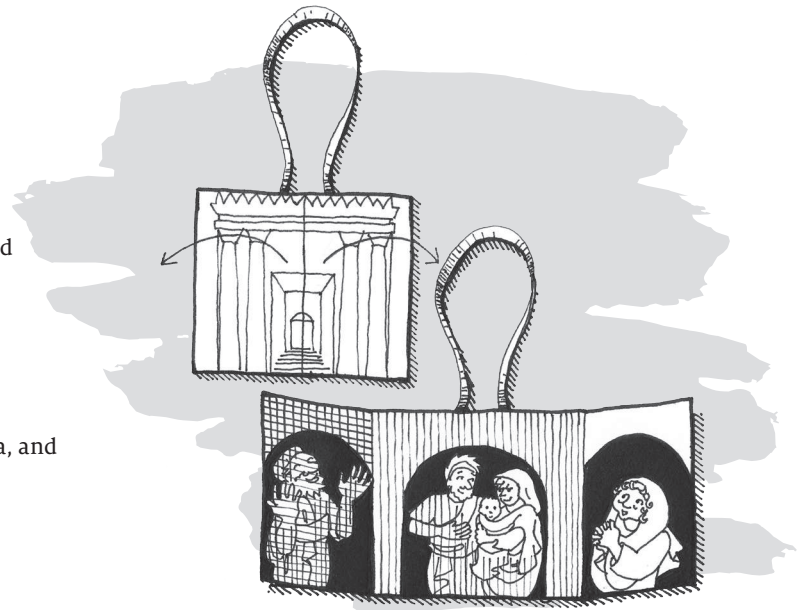

My eyes have seen your salvation  
that you have prepared in  
the presence of all peoples.

**LUKE 2:30–31 ESV**

temple template

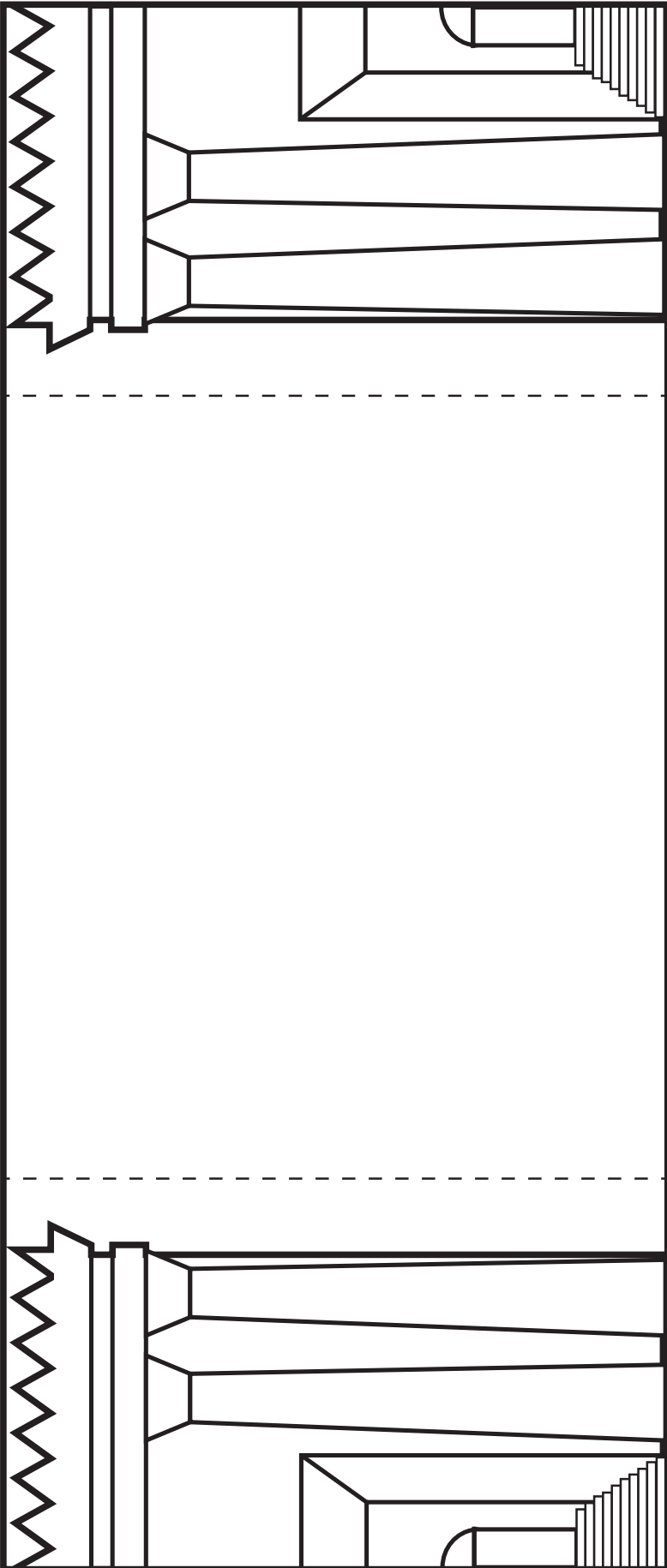

Anna template



Jesus's family template



Simeon template



## GOD IS WORSHIPPED BY WISE MEN

*Matthew 2:1-12*

From you [O Bethlehem] shall come a ruler who will shepherd my people Israel. (Matt. 2:6)

### SUPPLIES:

(to make one craft)

- 1 sheet of copy paper
- templates of star, robe, headpieces, and gifts (see page 135)
- scissors
- white stiffened felt or white cardstock
- hole punch
- ribbon (can be curling ribbon)
- at least 3 skin-colored, two-hole buttons made of wood or plastic
- several colors of self-adhesive craft foam
- hot-glue gun
- scissors
- optional:* markers
- optional:* hole punch

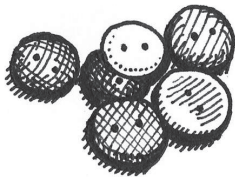

example of buttons needed

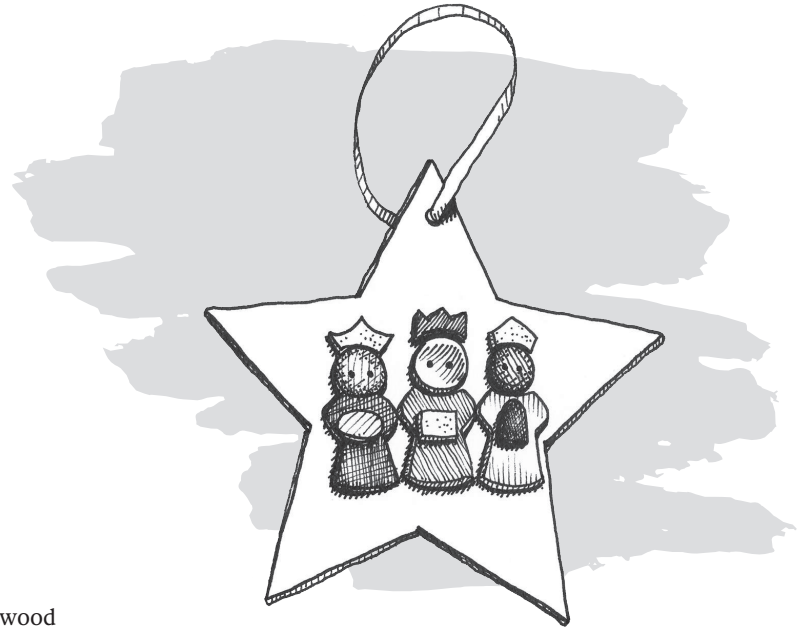

### INSTRUCTIONS:

**PREP STEP:** Copy the star, robe, headpieces, and gifts templates onto copy paper to use as patterns or onto cardstock if you're not using felt.

1. Use the template to cut a 5 ½-inch star from white stiffened felt or cardstock. Punch or cut a hole in one point a safe distance from the edges so that the felt or cardstock doesn't rip when the star is hanging. Thread a 10-inch length of ribbon through the hole and tie it off to form a hanger.
2. Using two-holed buttons for heads, cut robes, headpieces, and gifts from self-adhesive craft foam to make at least three wise men. (You can use the templates provided if you wish, adjusting the sizes as necessary to fit your buttons.) Arrange the men on your star with the hanger at the top, and have an adult attach the button heads to the felt with hot glue. Peel the backing from your foam pieces and stick them on the felt as well. Use markers to add any details you desire.
3. *Optional:* Cut out the illustrated verse and hot glue it to the back of the ornament with your name and the year.

**MAKE IT SIMPLE:** Hot glue the buttons to the stars ahead of time. Cut out the robes and headpieces in a variety of colors before class and let students mix and match them. If you haven't time to cut the small pieces, let students draw the robes, crowns, and gifts with markers.

**MAKE IT AMAZING:** Use glitter foam, glitter glue, small beads, sequins, and other notions to add further detail to your wise men.



From you [O Bethlehem]  
shall come a ruler who will  
shepherd my people Israel.

**MATTHEW 2:6 ESV**

robe, headpieces, and gifts templates

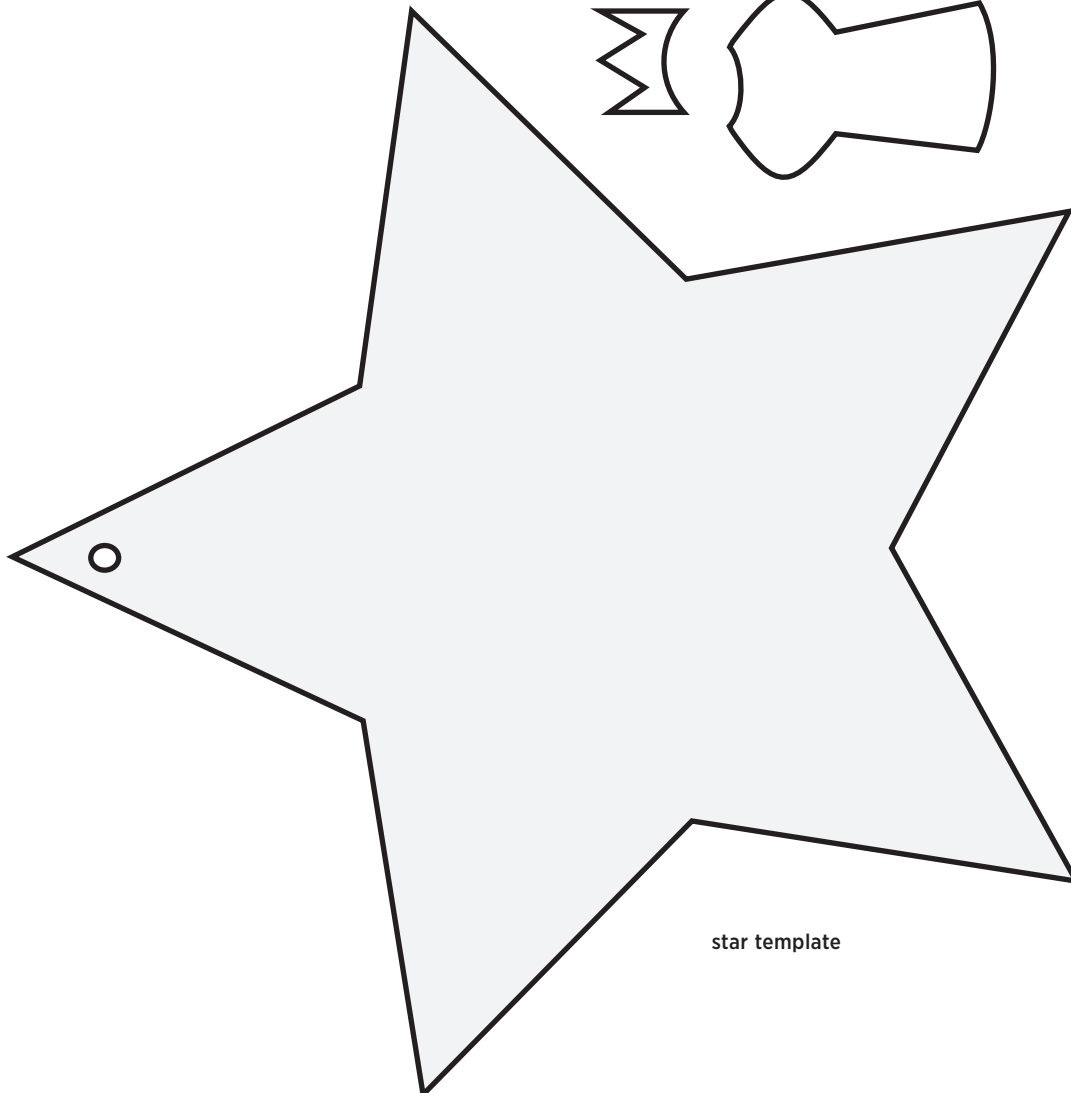
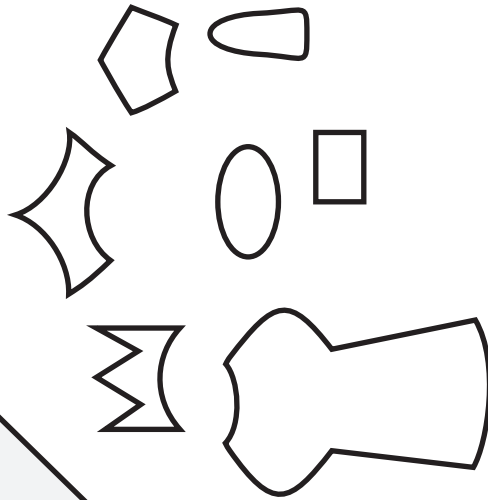

star template



## JESUS TEACHES TEMPLE LEADERS

Luke 2:41–52

Jesus increased in wisdom and in stature and in favor with God and man. (Luke 2:52)

### SUPPLIES:

(to make one craft)

- 2 sheets of white cardstock
- templates of the religious teachers (the full page), Herod's temple, and young Jesus (see pages 137–38)
- crayons or markers
- scissors
- optional*: craft knife such as X-acto™
- glue

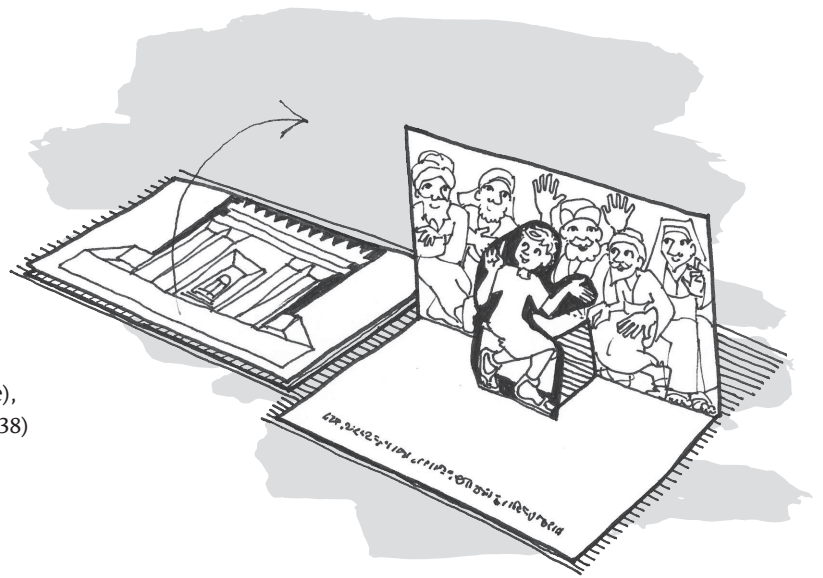

### INSTRUCTIONS:

**PREP STEP:** Copy the full-page template of the teachers, the templates of Herod's temple, and young Jesus onto white cardstock.

1. Color the picture of the teachers. Cut the two solid vertical slits with scissors or *optional* craft knife. Fold the page in half on the long, horizontal dotted line, then open it 90 degrees. Invert the crease between the slits to make that section pop up and crease on the dotted lines at the top and bottom of that section.

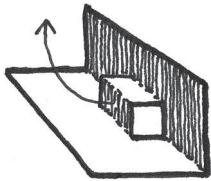

Step 1

2. Color Herod's temple and young Jesus and cut them out.
3. Paste young Jesus onto the vertical section of the pop-up (put paste on the rectangle rather than on Jesus, since most of him will be unattached). Make sure the bottom of his feet are aligned with the bottom of the pop-up so that he disappears completely when the page is closed.
4. Fold the page down and paste on the temple with its top edge aligned with the crease to cover the hole created by the pop-up. Now when the temple is "opened" by lifting the top half of the page, young Jesus pops up in the middle of a group of teachers.

**MAKE IT SIMPLE:** Copy, cut, and crease ahead of time.

**MAKE IT AMAZING:** Draw Joseph and Mary searching for Jesus on the back of the "closed" temple.



Jesus increased in wisdom and in stature and in favor with God and man.  
**LUKE 2:52 ESV**

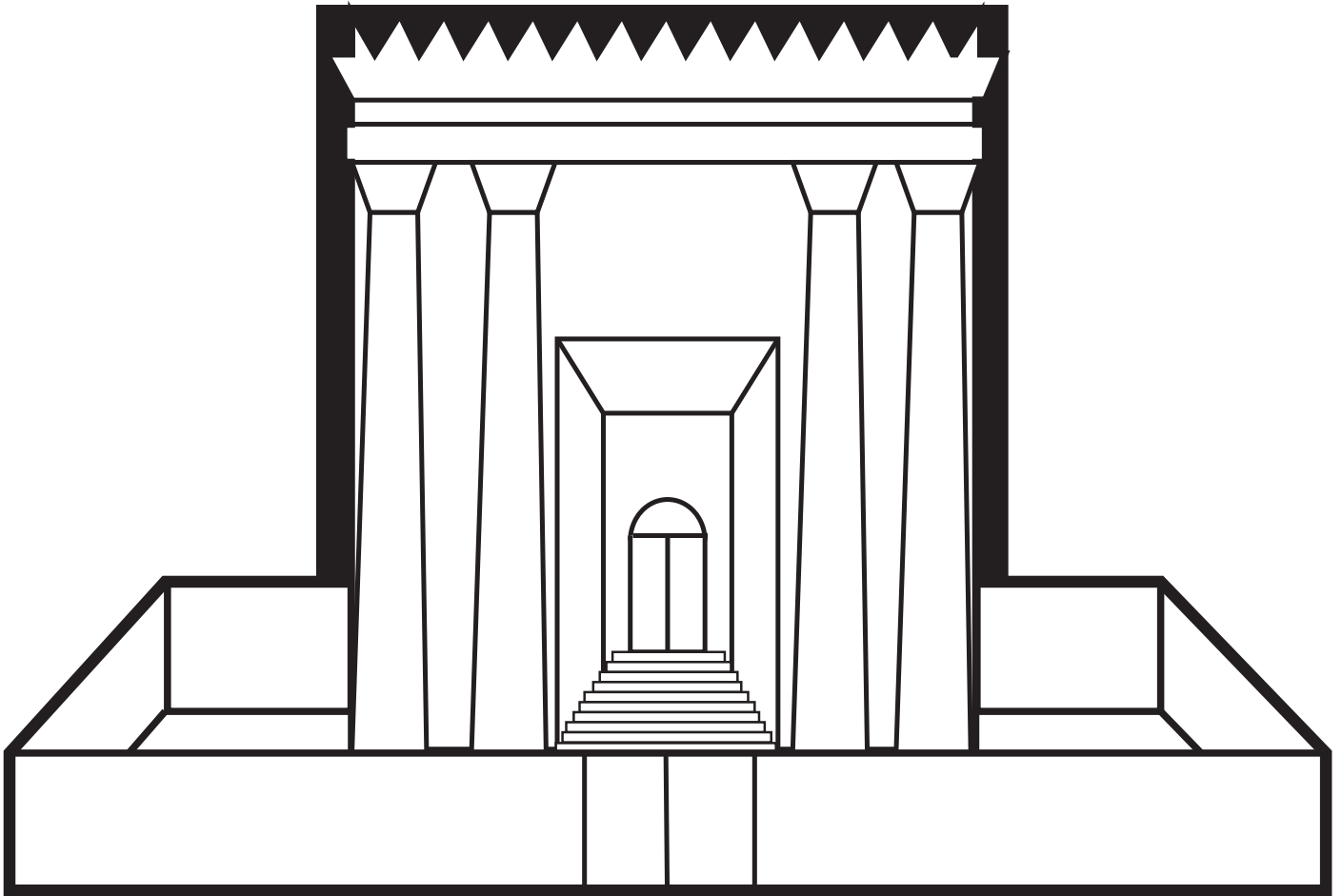

Herod's temple template



young Jesus template

## JESUS IS BAPTIZED

*Matthew 3:1-17; Mark 1:1-11; Luke 3:1-22; John 1:19-34*

Behold, the Lamb of God, who takes away the sin of the world! (John 1:29)

### SUPPLIES:

(to make one craft)

- 1 sheet of white or tan cardstock
- template of John the Baptist (see page 140)
- crayons or markers
- scissors
- glue
- a 4 x 6-inch rectangle of camel-colored disposable blanket or towel from a thrift store
- 12 inches of a leather thong or twine

### INSTRUCTIONS:

**PREP STEP:** Copy the template of John onto white or tan cardstock.

1. Color John and fold him on the dotted line. Cut him out along the edges of the dark section behind him, paying attention to both his front and back as you cut. Paste the front and back sides together to make one double-sided John.
2. Wrap a 4 x 6-inch rectangle of fabric that looks like camel hair around John and tie it in place with a 12-inch piece of leather thong or twine around his waist.
3. *Optional:* Cut out the illustrated verse and glue it to John's back.

**MAKE IT SIMPLE:** Copy and cut out John ahead of time, but let students color, fold, and paste him. Have fabric and ties cut to size.

**MAKE IT AMAZING:** Enlarge the Jesus from Craft 83 "Jesus Visits Zacchaeus" by 150 percent and reduce this John template to 60 percent so that they are the same size. Wrap Jesus in a piece of purple, blue, or white fabric similar to the way you wrapped John in the "camel hair." Place both figures on a backing sheet in crepe-paper-streamer "water" and draw or cut out and glue a white dove descending toward Jesus.

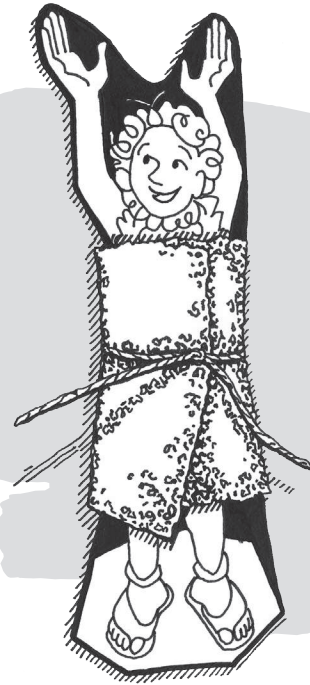

John the Baptist template

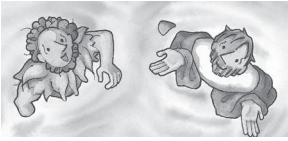

Behold, the Lamb of God, who takes away the sin of the world!  
**JOHN 1:29 ESV**



## JESUS RESISTS TEMPTATION

*Matthew 4:1-11; Luke 4:1-13*

You shall worship the Lord your God, and him only shall you serve. (Luke 4:8)

Man does not live by bread alone, but man lives by every word that comes from the mouth of the LORD. (Deut. 8:3)

You shall not put the Lord your God to the test. (Luke 4:12)

### SUPPLIES:

*(to make one craft)*

- 2 sheets of white cardstock
- templates of three temptation ovals and the full page of Jesus with responses (see page 142-43)
- crayons or markers
- scissors
- 3 pieces of tape

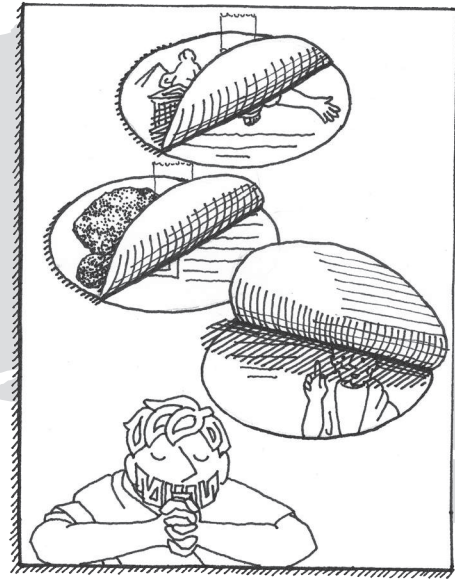

### INSTRUCTIONS:

**PREP STEP:** Copy the full-page template of Jesus with responses and the three temptation ovals templates onto white cardstock.

1. Color the pictures and cut out the three temptation ovals.
2. Place the three temptation ovals over the corresponding responses from Jesus (kingdoms at the top, then bread and stones, then the temple). Place a single piece of tape vertically at the top and center of each oval to make each oval into a flap that can be lifted to see what is underneath.

**MAKE IT SIMPLE:** Cut out the three ovals ahead of time. Place three pieces of tape at each student's workspace.

**MAKE IT AMAZING:** In the white space around Jesus and the ovals, draw the animals and angels who came to minister to Jesus during his temptation (Mark 1:12-13).



You shall worship the Lord your God,  
and him only shall you serve.

**LUKE 4:8 ESV**

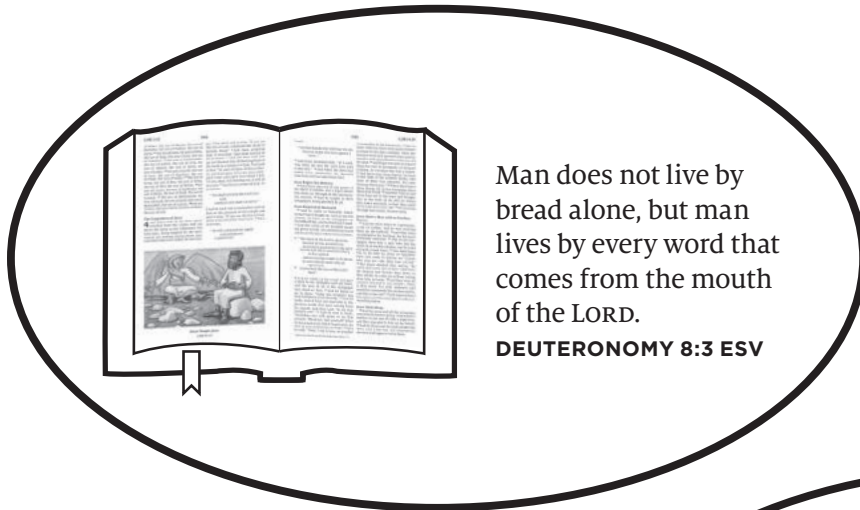

Man does not live by  
bread alone, but man  
lives by every word that  
comes from the mouth  
of the LORD.

**DEUTERONOMY 8:3 ESV**

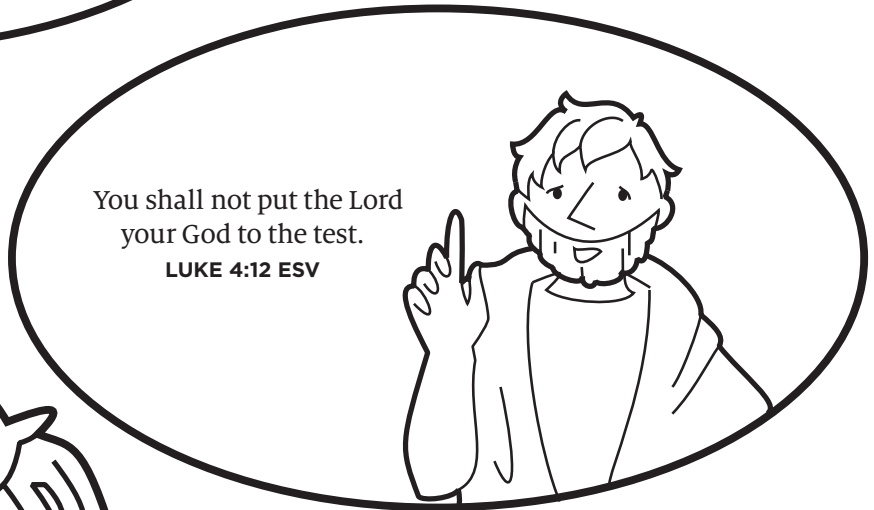

You shall not put the Lord  
your God to the test.

**LUKE 4:12 ESV**



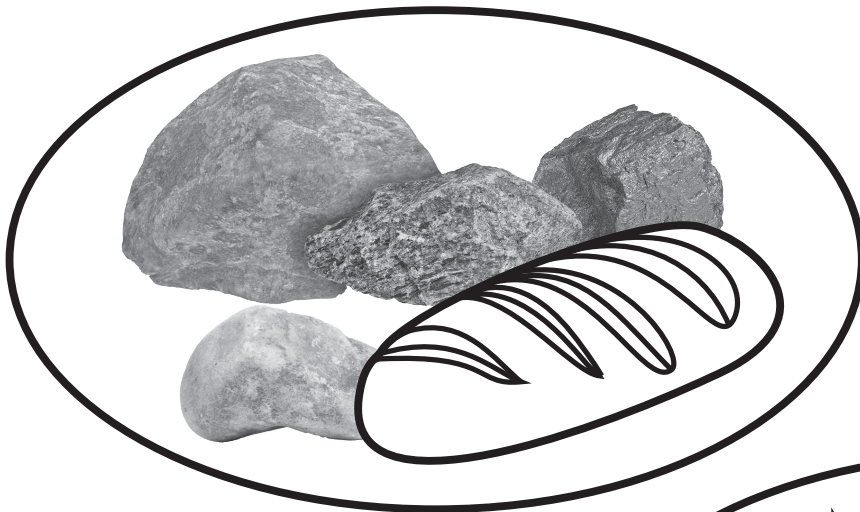
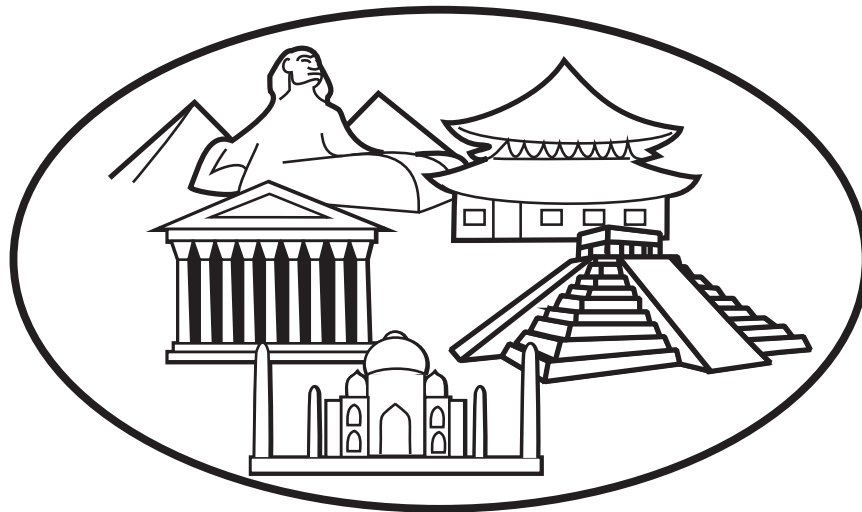

temptation oval templates

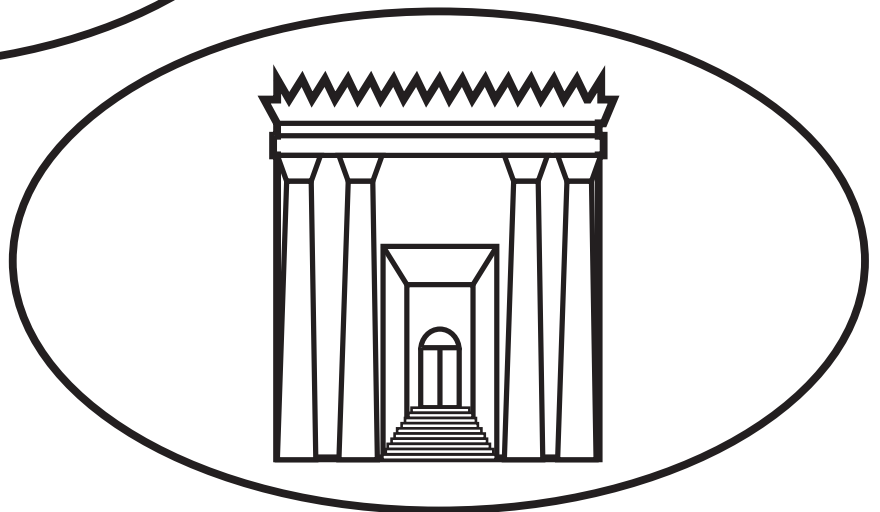

## JESUS CALLS TWELVE DISCIPLES

*Matthew 4:18-22; 10:1-4; Mark 1:16-20; 3:13-19;  
Luke 5:2-11; 6:12-16; John 1:40-51*

And [Jesus] said to them, "Follow me, and I will make you fishers of men." (Matt. 4:19)

### SUPPLIES:

(to make one craft)

- 1 sheet of white or light-colored cardstock
- templates of twelve fish-disciples (see page 145-46)
- crayons or markers
- scissors
- 12 paper clips
- 14- to 24-inch stick, dowel rod, or 11 x 17-inch sheet of paper
- 4 to 5 feet of string or yarn
- optional: hot-glue gun or packing tape
- 2 craft magnets
- 1 net bag from fresh produce

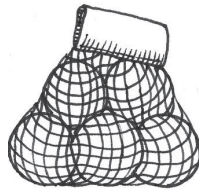

example of net produce bag needed

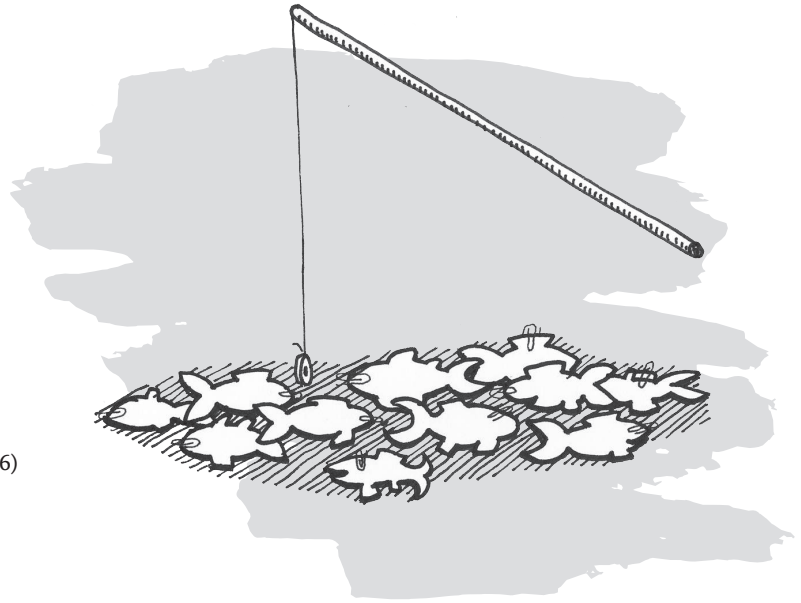

### INSTRUCTIONS:

**PREP STEP:** Copy the twelve templates onto white- or light-colored cardstock.

1. Color the twelve fish with disciples drawn on them and cut them out. Place one paper clip anywhere you wish on each fish.
2. Create a fishing pole:
  - (a) *If you are using 11 x 17 paper*, roll it tightly lengthwise. Before you begin rolling, lay the first 14 inches of a 4- to 5-foot length of string or yarn across the center of your paper lengthwise. As you roll the paper, the string will be captured inside the "stick."

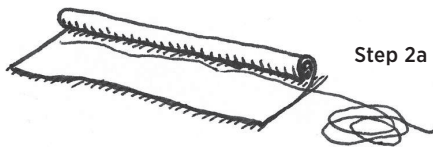

(b) *If you are using a real stick or a dowel rod*, tie one end of your string to one end of your stick, then secure it with hot glue (with an adult's help) or packing tape.

3. Fasten two magnets to the other end of your fishing line. If the magnets have holes in the center, thread the string through the holes to tie them on. If the magnets do not have holes in them, hot glue them together, sandwiching the string between the two magnets.

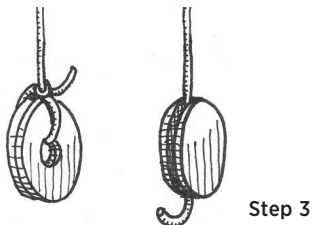

4. Use your pole to “fish for men” and then keep the twelve disciples in your “fishing net” (the netted produce bag).

5. *Optional:* Cut out the illustrated verse and staple it to your fishing net.

**MAKE IT SIMPLE:** When you cut out the fish, skip the fins except for those that contain the disciples’ hands. If you have not been saving produce netting, you can purchase it in bulk online or just use plastic zipper storage bags. Assure students that they can finish coloring the disciples at home.

**MAKE IT AMAZING:** Decorate the reverse sides of the fish with googly eyes, mini-cupcake-liner fins, and scales drawn with markers or glitter glue. To make the fishing more challenging, use a partially open paper clip instead of magnets on each line, and bend the clips on the fish so that a loop of each clip sticks up when the fish lay flat.

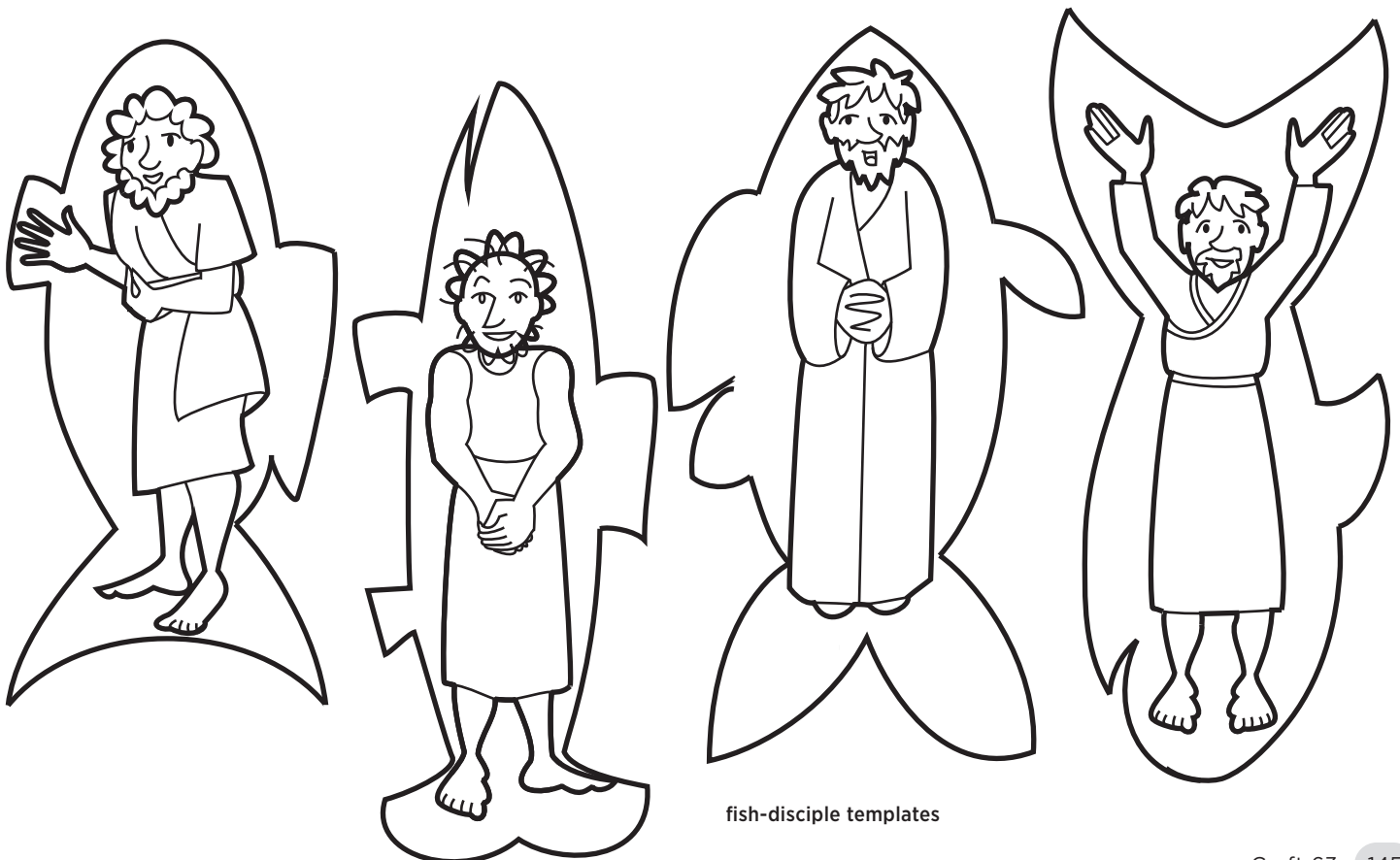
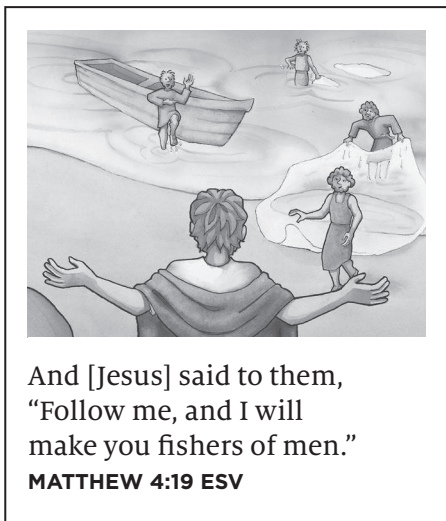

fish-disciple templates

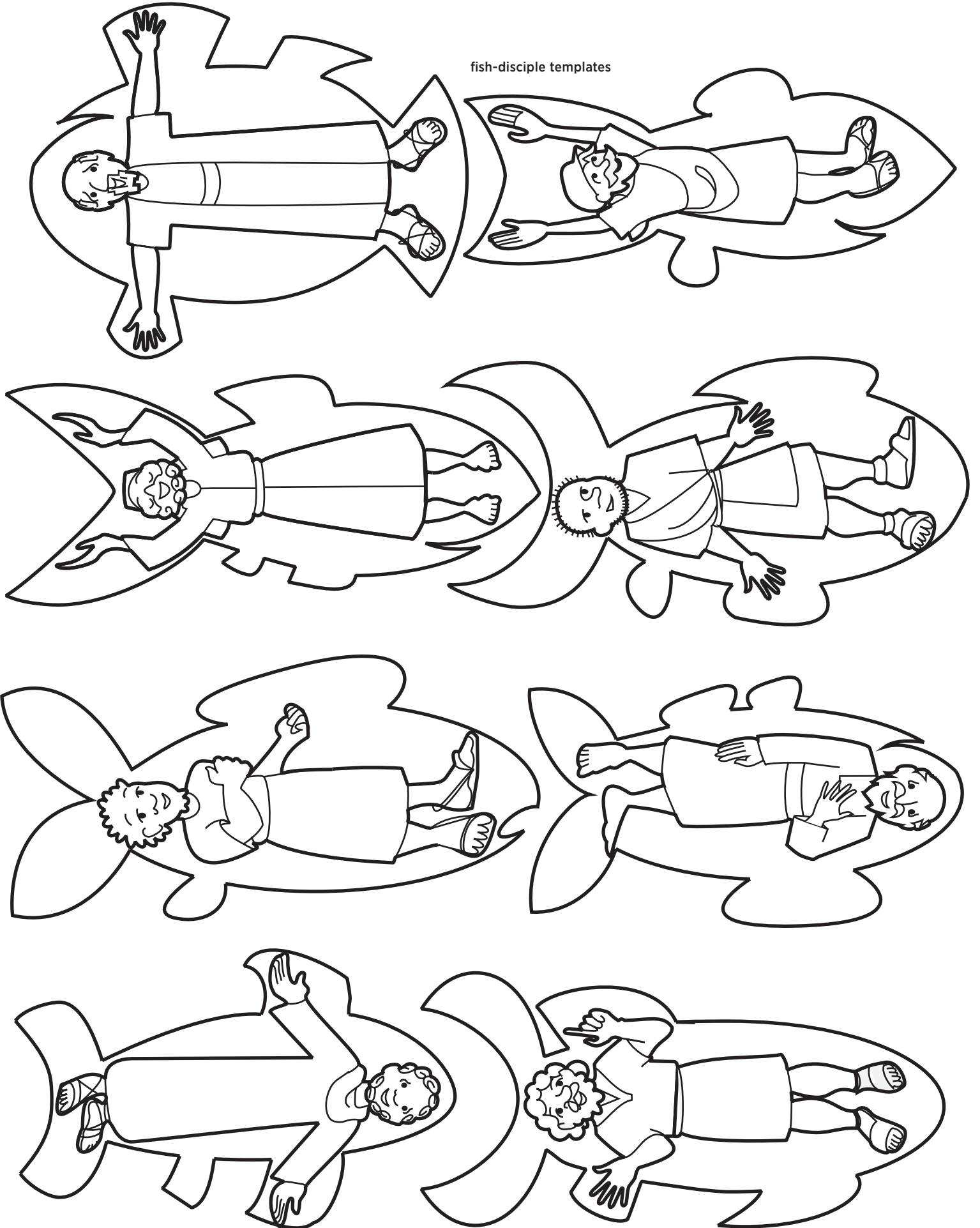



## JESUS PERFORMS A MIRACLE AT CANA

*John 2:1-12*

The Word became flesh and dwelt among us, and we have seen his glory. (John 1:14)

### SUPPLIES:

(to make one craft)

- 2 sheets of white cardstock
- templates of the jar and circle (see pages 148–49)
- scissors
- craft knife such as X-Acto™
- crayons or markers
- 1 blue crayon or marker (or paper)
- 1 red crayon or marker (or paper)
- 1 brass fastener

### INSTRUCTIONS:

**PREP STEP:** Copy the jar and circle templates onto white cardstock.

1. First fold the jar on the dotted line, then cut it out without cutting off the crease. Open the crease and lay the double jar flat. On the side with the little ⊗, use a craft knife to cut the solid curve that begins and ends at the same points as the dotted line below the ⊗. Now fold the rounded flap up, crease on the dotted line, and lower the flap again. Color the jar. Use a craft knife to make tiny cuts on the lines of the little ⊗.
2. Cut out the circle. Color one semicircle blue and the other semicircle red, leaving a white border all around the circle. Or use the circle template to draw and cut semicircles from red and blue paper, and paste them into place on your white circle. Use a craft knife to make tiny cuts on the lines of the little ⊗.
3. Refold the jar shut with the crease on the left, this time with the circle face-up inside. (A white edge of the circle will remain outside the jar on the right side.) Line up the ⊗ in the circle with the ⊗ on the jar, and insert a closed brass fastener through the top layer of the jar, the circle, and then the bottom layer of the jar. Open the fastener behind the jar to hold the jar shut.
4. Lift the flap and view the “beverage” inside the jar: It will either be blue “water” or red “wine.” Close the flap and turn the circle halfway around using the exposed edge on the right. Lift the flap again to reveal that the “beverage” has changed!
5. *Optional:* Cut out the illustrated verse and paste it to your jar.

**MAKE IT SIMPLE:** Cut out and crease all of the pieces before class. Make sure there are enough red and blue crayons or markers to go around, or prepare red- and blue-paper semicircles to be pasted. Demonstrate an assembled jar before beginning, so the students understand what they are creating.

**MAKE IT AMAZING:** Add red glitter to your “wine” semicircle, and cut and paste a single layer of a clear sheet protector over your “water” semicircle.





The Word became flesh and dwelt among us, and we have seen his glory. **JOHN 1:14 ESV**

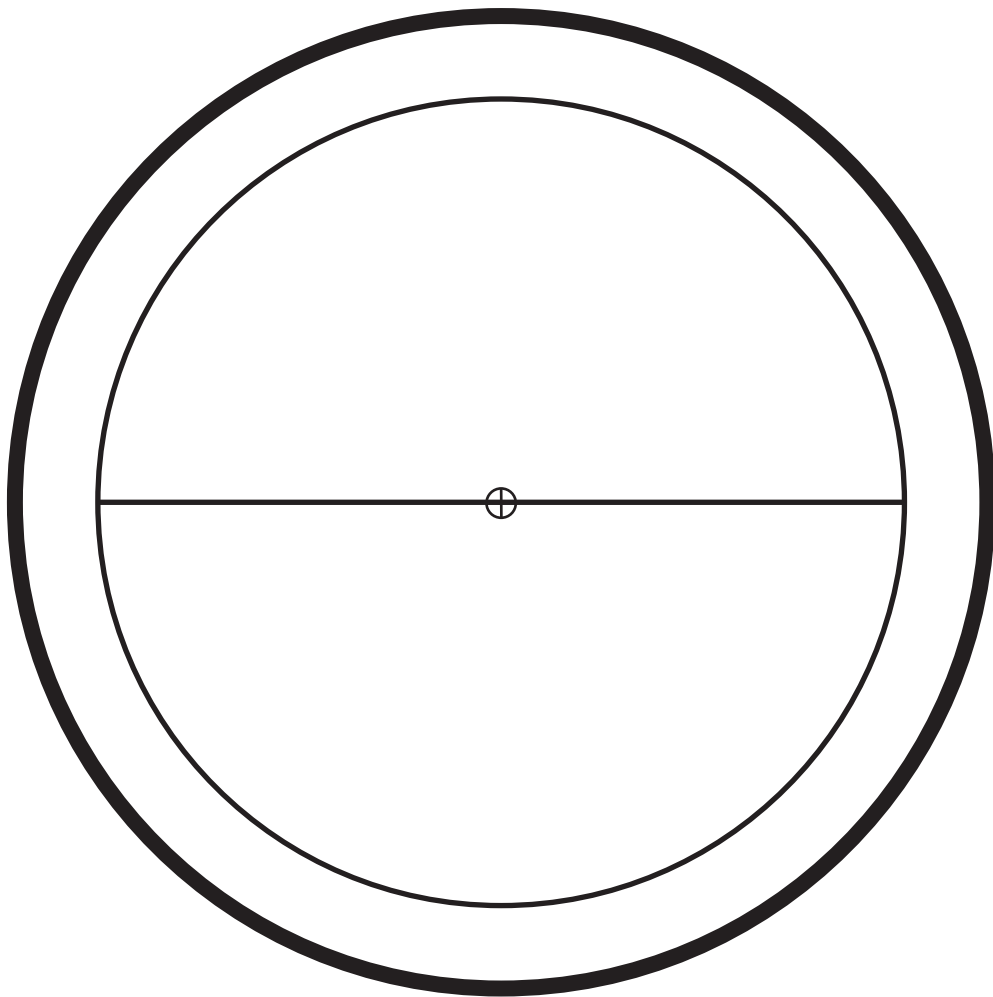

circle template

jar template

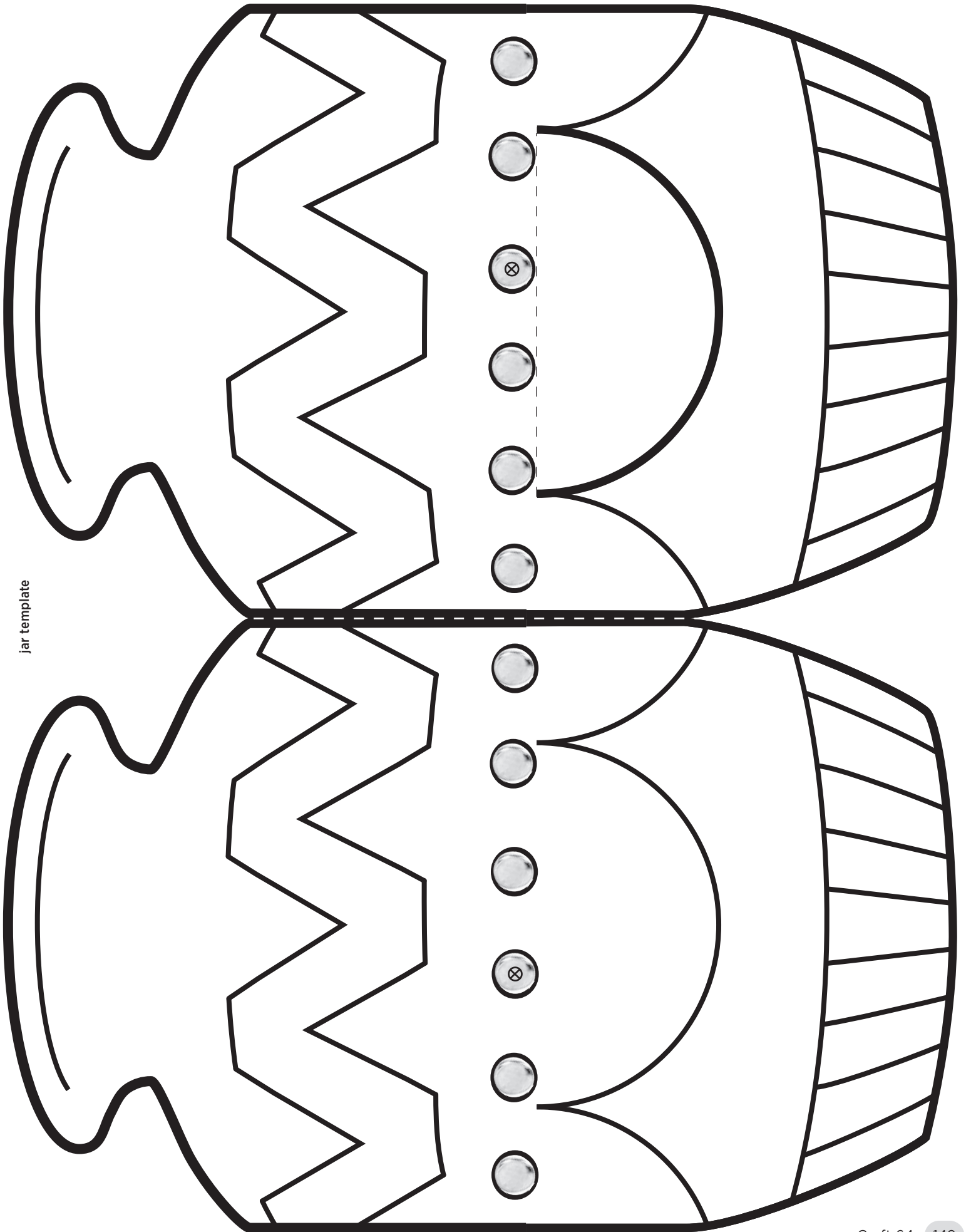

## JESUS HEALS A PARALYZED MAN

Mark 2:1-12; Luke 5:17-26

The Son of Man has authority on earth to forgive sins.  
(Mark 2:10)

### SUPPLIES:

(to make one craft)

- 2 sheets of white cardstock
- templates of crowded room, Jesus, and five friends with ropes (see pages 151-52)
- crayons or markers
- scissors or optional craft knife such as X-Acto™
- glue

### INSTRUCTIONS:

**PREP STEP:** Copy the three templates onto white cardstock.

1. Color the pictures of the crowded room, Jesus, and the five friends with ropes. Cut out Jesus, the five friends (as one piece), and the rectangular hole in the roof of the crowded room (with a craft knife if you prefer).
2. Cut slits along the four solid horizontal lines near the corners of the crowded room and fold inward on the dotted lines. Paste the four corner flaps to the outsides of the sidewalls to “form the room.”

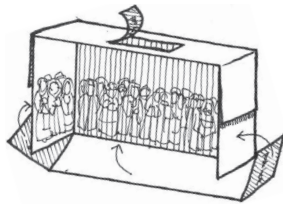

Step 2

3. Fold the rope panels up 90 degrees from the paralyzed man's mat, then fold the end panels, each with two friends holding the ropes, down 90 degrees. Lower the mat and ropes through the hole in the roof and paste the friends to the top of the roof.

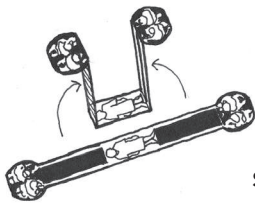

Step 3

4. Fold the “paste here” section under Jesus back 90 degrees to form a base, then paste it to the floor of the room where you want Jesus to stand.
5. *Optional:* Cut out the illustrated verse and paste it to the room.

**MAKE IT SIMPLE:** Cut everything out ahead of time. Crease on the dotted lines, then open flat to color.

**MAKE IT AMAZING:** Make two crowded-room halves, but only cut out the roof hole in one of them. Stand the rooms side-by-side, then tape the touching front edges of one side together to form a hinge. Now the full room can close like a box or open to reveal the healing scene.



paste here



paste here

cut out

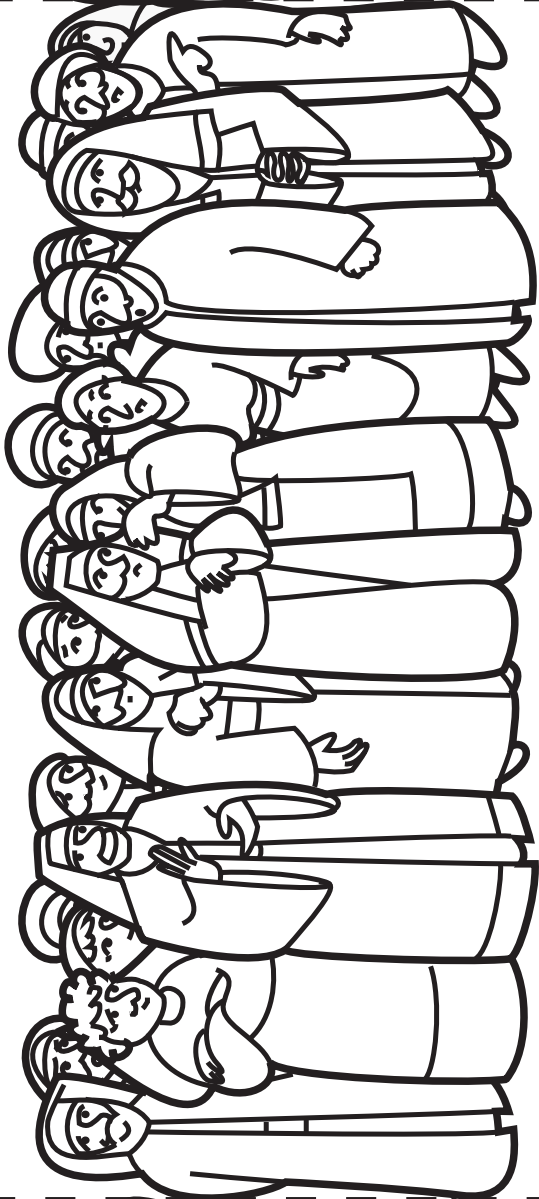

paste here



paste here

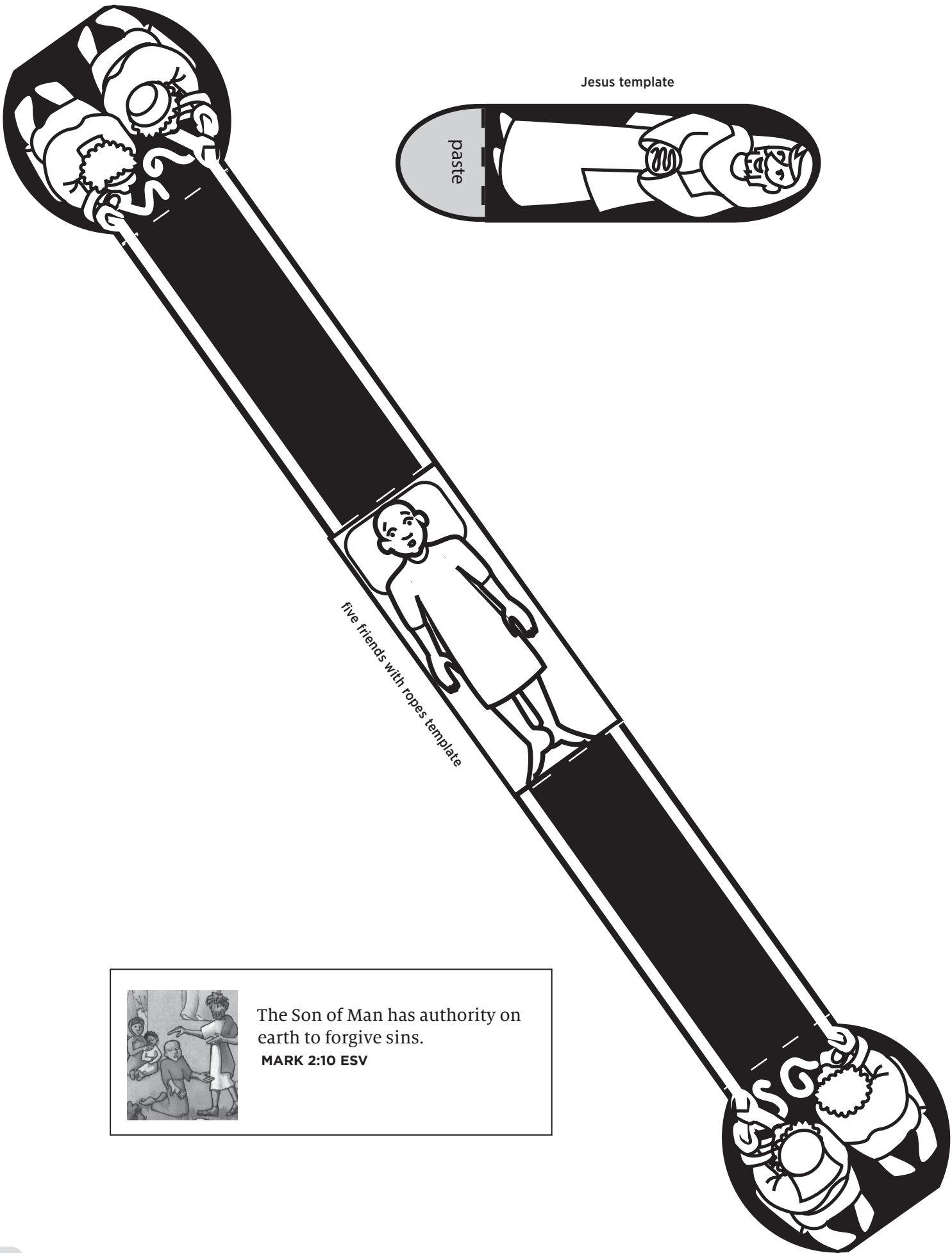

Jesus template

paste

five friends with ropes template



The Son of Man has authority on earth to forgive sins.  
**MARK 2:10 ESV**



## JESUS TALKS TO NICODEMUS

*John 3:1-21; 7:40-52; 19:38-42*

Jesus answered him, "Truly, truly, I say to you, unless one is born again he cannot see the kingdom of God."  
(John 3:3)

### SUPPLIES:

(to make one craft)

- 1 sheet of white cardstock
- templates of four small squares and of one large square-with-flaps (see page 154)
- crayons or markers
- scissors
- glue

### INSTRUCTIONS:

**PREP STEP:** Copy the templates of the four small squares and the large square onto white cardstock.

1. Color the images and cut them out.
2. Fold the four flaps of the big square inward on the dotted lines so that the edges of the flaps line up. Determine which of the four small squares goes onto which flap to form a complete picture of Jesus and Nicodemus talking at night, then paste the squares onto those flaps.
3. When the flaps are folded, you see the conversation. Each unfolded flap reveals actions that Nicodemus took as a result of meeting Jesus that night.
4. *Optional:* Cut out the illustrated verse and paste it to the back of the big square.

**MAKE IT SIMPLE:** Cut out and crease all pieces before class.

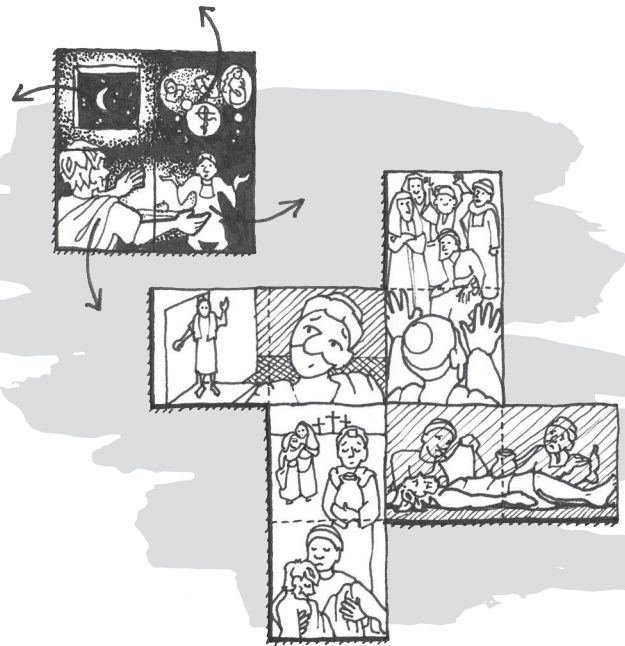

Jesus answered him, "Truly, truly, I say to you, unless one is born again he cannot see the kingdom of God."

JOHN 3:3 ESV

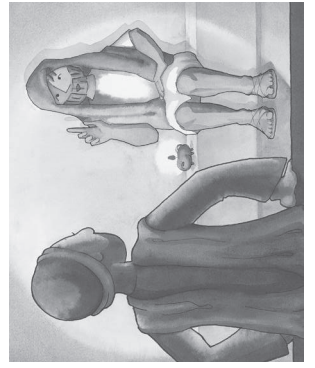

small square template



small square template

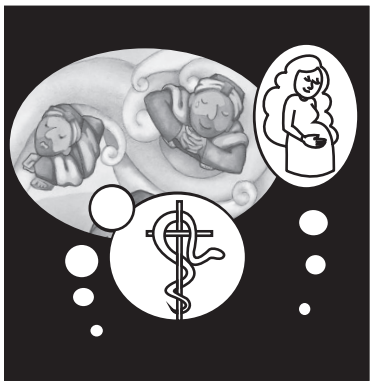
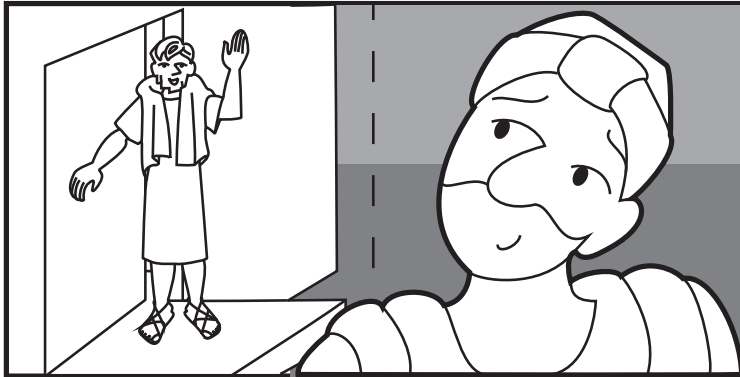
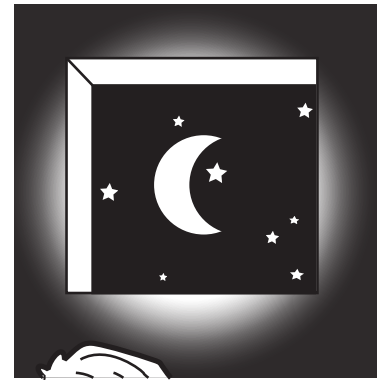

small square template



large square template



small square template

## JESUS HEALS A LITTLE GIRL

*Matthew 9:18-26; Mark 5:21-43; Luke 8:40-56*

Jesus said . . . "Do not fear, only believe." (Mark 5:36)

### SUPPLIES:

(to make one craft)

- 2 sheets of white cardstock
- templates of girl and her bedroom (see pages 156-57)
- crayons or markers
- craft knife such as X-acto™
- scissors
- glue
- tape
- 1 flexible drinking straw

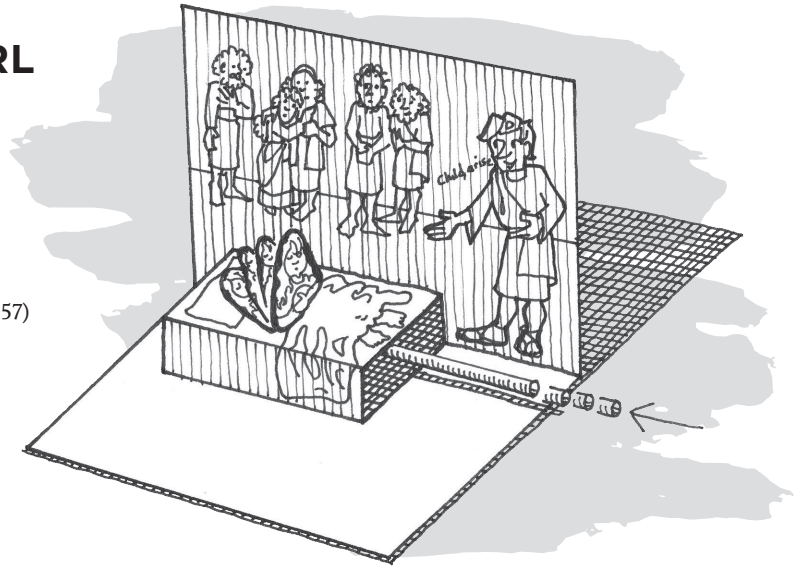

### INSTRUCTIONS:

**PREP STEP:** Copy the template of the girl and the full-page template of her bedroom onto separate sheets of white cardstock.

1. Color the room picture. Use a craft knife to cut the solid lines at the head and foot of the bed and to completely cut out the black rectangle slot in the bed. Gently fold the page in half crosswise, creasing it only in the dotted lines outside the head and foot of the bed. Open the picture 90 degrees and pull the bed up as shown, inverting the crease at the top outer edge of the bed and creasing all three folds well.

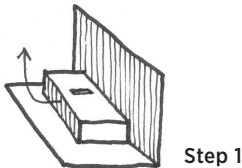

Step 1

2. Color the girl and cut her out. Fold her hair down behind her and fold the "paste here" flap up in front of her.



Step 2

3. Fit the "paste here" flap down through the slot in the bed and secure it to the underside of the bed with tape. (Turn the craft upside-down to gain access to this area.)
4. Bend a flexible drinking straw at a 90-degree angle and place it so that the long end sticks out from under the foot of the bed, and the short end goes up the slot and into the space between the girl's face and hair. Tape the straw to the back of the girl's face, then tape her hair down over the straw.

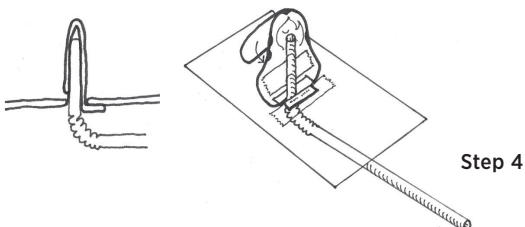

Step 4

5. Hold the craft with your left hand and use your right hand to push the straw in and out of the bed. This will make the girl lie down “dead” and then sit up when Jesus calls to her.
6. *Optional:* Cut out the illustrated verse and paste it to your craft.

**MAKE IT SIMPLE:** Cut and crease before class, but smooth the images flat to color. You can attach the girl to the bed via the “paste here” tab ahead of time, but do not insert the straw until coloring is complete.



girl template

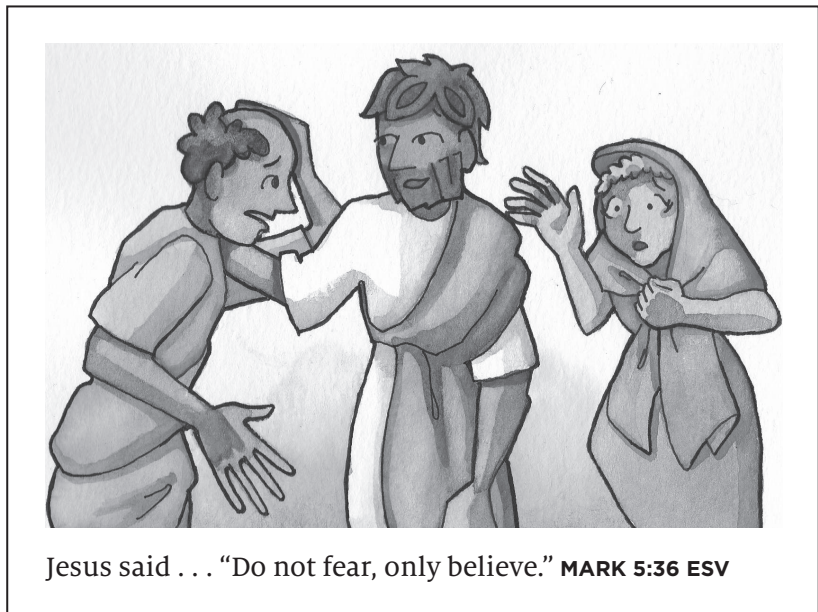

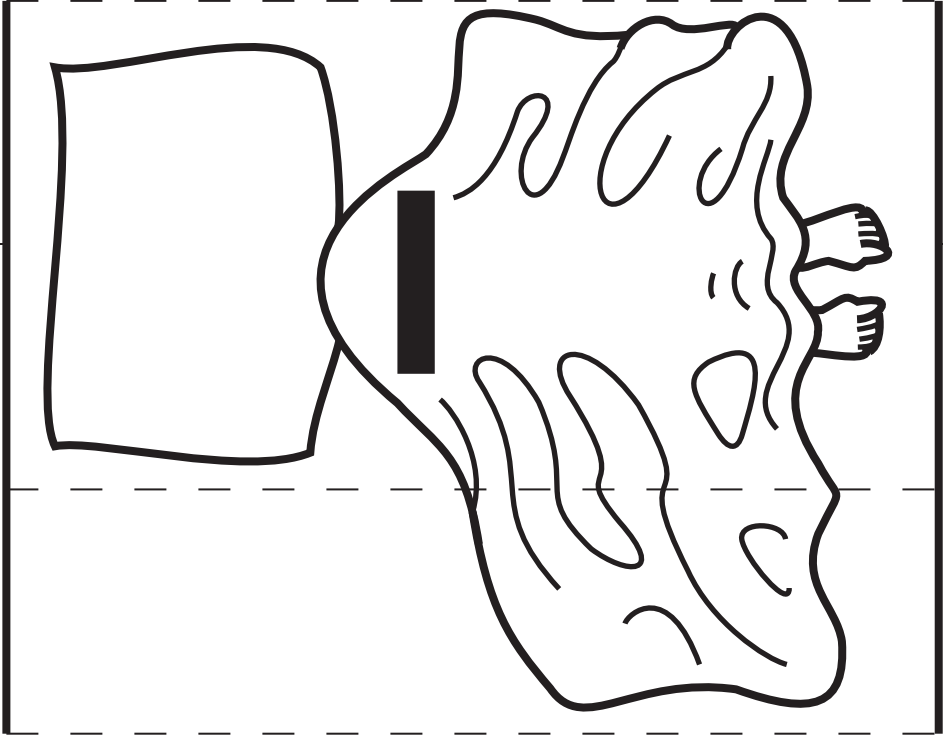
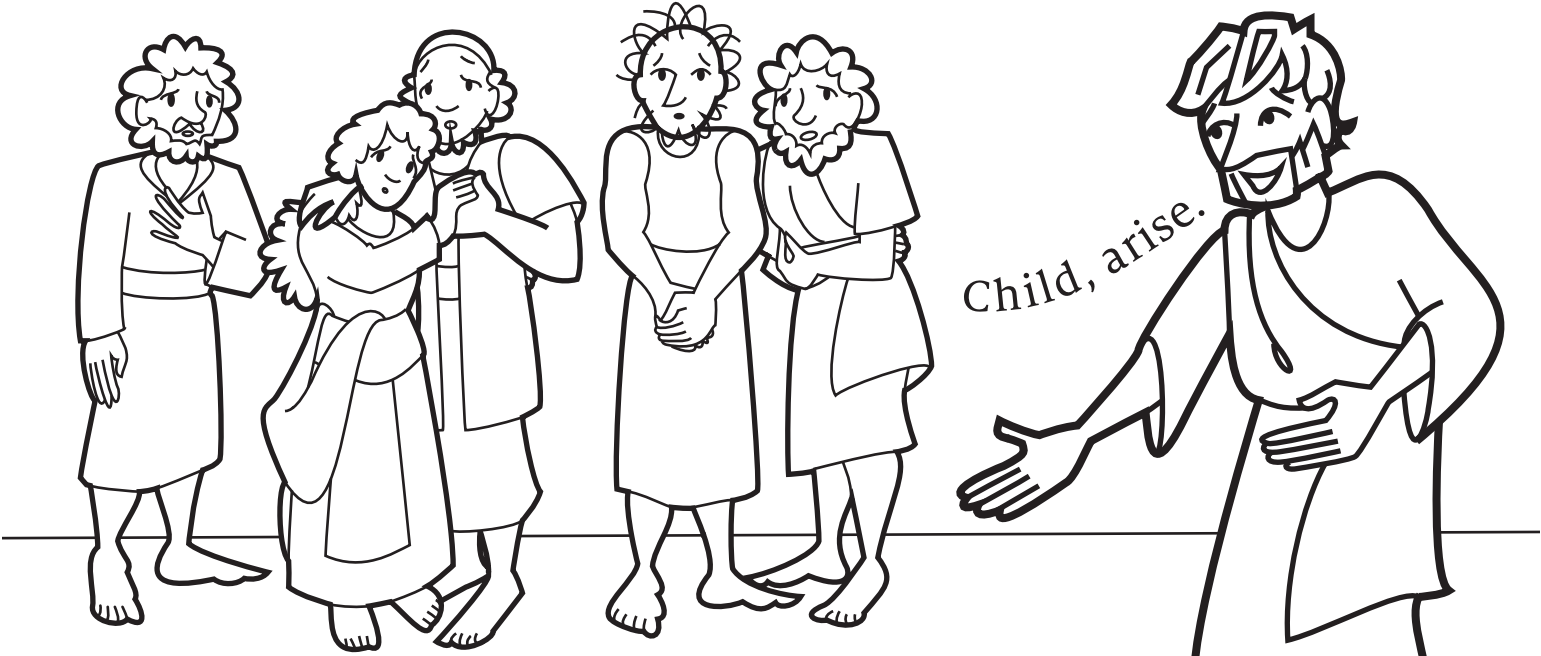



## JESUS IS ANOINTED AT BETHANY

Mark 14:3–9; Luke 7:36–50

Her sins, which are many, are forgiven—for she loved much. (Luke 7:47)

### SUPPLIES:

(to make one craft)

- 1 sheet of white copy paper
- 2 sheets of skin-colored paper
- templates of alabaster jar and feet (see page 159–60)
- scissors
- 1 sheet of black paper
- pencil
- 1 sheet of any colored paper for backing
- glue or tape
- tan or honey-colored paint or glitter glue (or a marker if necessary)
- a paintbrush

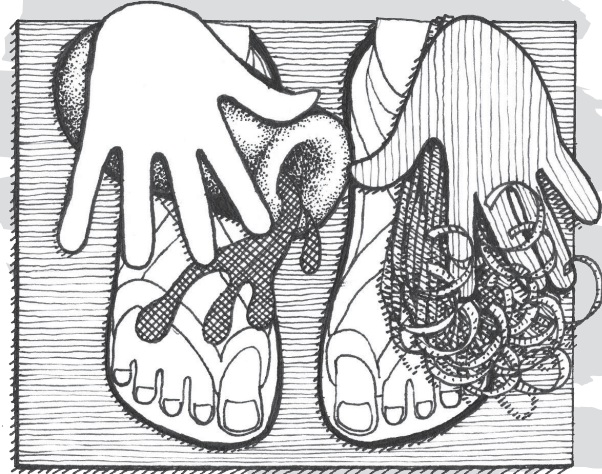

### INSTRUCTIONS:

**PREP STEP:** Copy the template of the alabaster jar onto white paper. Copy the templates of Jesus's feet onto skin-colored paper.

1. Cut out the alabaster jar and Jesus's feet. Choose a second piece of skin-colored paper twice as large as your hand, fold it in half, trace your hand with fingers spread onto it, and cut out both hand shapes at once.
2. Roll the black paper somewhat tightly, wrapping it around a pencil at first to get it started. Leave an inch unrolled and slide the pencil out. Create strands of black, curly hair by making parallel cuts approximately every  $\frac{1}{4}$  inch, through the roll but not all the way through the unrolled paper at the top.

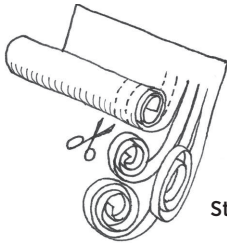

Step 2

3. Paste Jesus's feet to a sheet of colored paper. Arrange the jar in one hand as shown above, so that the jar is tilted to pour out nard over a foot. Paste or tape them in place. Use paint or glitter glue to make nard running out of the jar and onto the foot.
4. Arrange the black "hair" under the other hand so that the hand is using the hair to wipe the other foot dry, then paste or tape them in place. Trim the ends of the hair to the length you want.
5. *Optional:* Cut out the illustrated verse and paste it to your craft.

**MAKE IT SIMPLE:** Paste feet to the backing sheet ahead of time and/or make the hair ahead of time. Trace and label the children's hands as they enter the classroom, then have an assistant cut them out before craft time. If need be, you can skip the hands and just add the hair and jar of nard.

**MAKE IT AMAZING:** Trace your own feet instead of using the template. Trace your tennis-shoe soles onto a brown paper bag, cut them out, and slip them under your paper feet. Use leather thong cord from a craft store to make straps and ties for the sandals.





alabaster jar template



Her sins, which are many, are forgiven—for she loved much.

**LUKE 7:47 ESV**

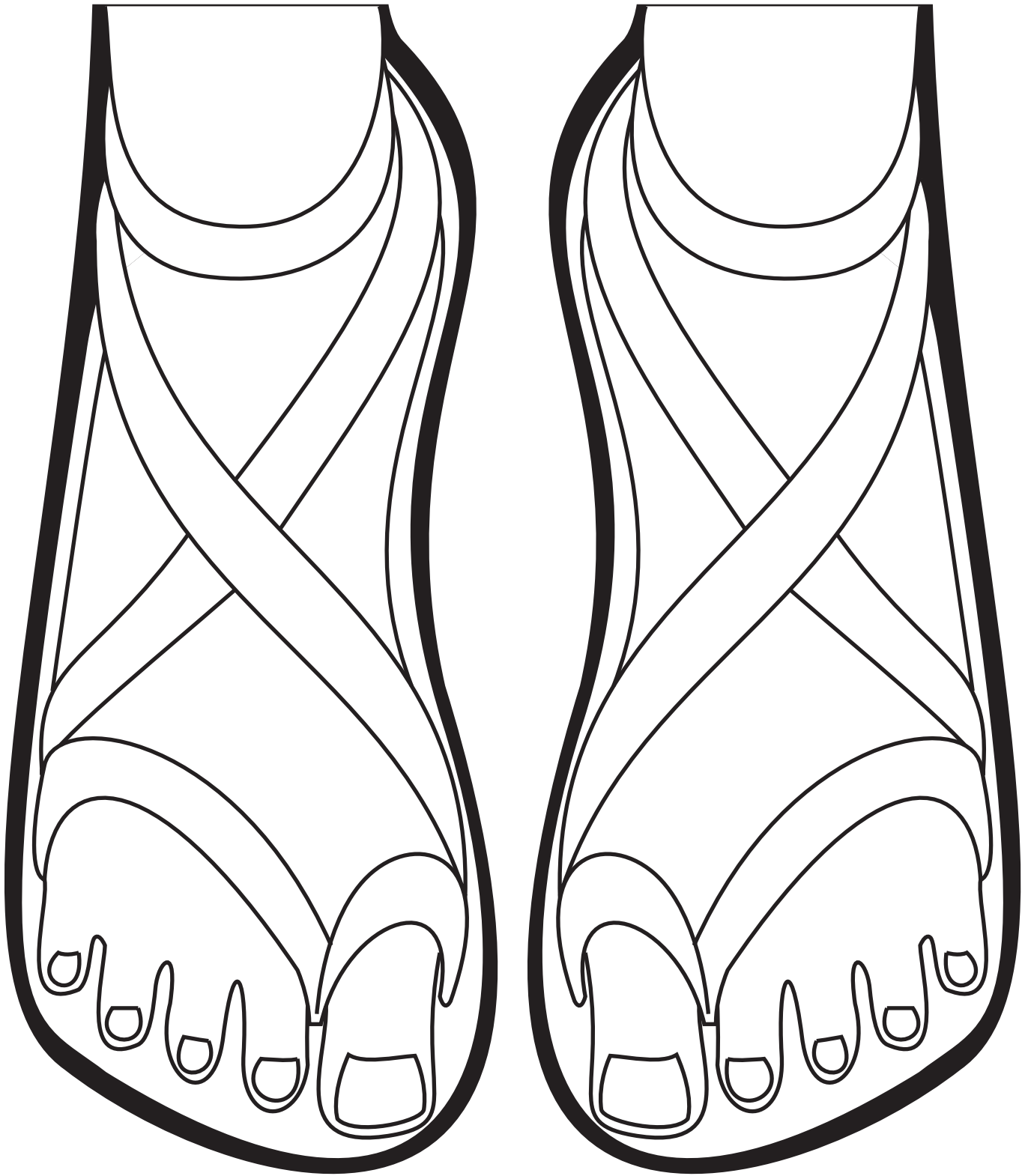

Jesus's feet template

## JESUS MEETS A SAMARITAN WOMAN

*John 4:1-42*

Whoever drinks of the water that I will give him will never be thirsty again. (John 4:14)

### SUPPLIES:

(to make one craft)

- 2 sheets of white cardstock
- templates of Jesus, the woman, and the stone well (see pages 162–63)
- scissors
- stapler
- glue
- crayons or markers
- 12 x 12-inch sheet of plastic wrap



### INSTRUCTIONS:

**PREP STEP:** Copy the Jesus, Samaritan woman, and stone well templates onto white cardstock.

1. Cut out the well, gently fold it in half lengthwise, curl it into a cylinder, tuck one end into the other, and staple or glue it in place.
2. Color Jesus and the Samaritan woman, fold them on the dotted lines so that they are double-sided, and cut them out along the edges of the dark shapes behind them, watching both sides as you cut. Paste their halves together so they stay closed.
3. Use a single staple to attach Jesus to the outside of the well (his feet even with the bottom of the wall) and attach a corner of the plastic wrap to the inside of the well in the same place.
4. Use another single staple to attach the Samaritan woman looking down at Jesus from the opposite side of the well, and the other corner of the plastic wrap inside the well.
5. Arrange the rest of the plastic wrap loosely inside the well to look like water.
6. *Optional:* Cut out the illustrated verse and paste it to the outside of the well.

**MAKE IT SIMPLE:** Construct the wells and cut out the human figures before class.

**MAKE IT AMAZING:** Before curling the well into a cylinder, coat what will be the outside with a solid layer of glue and cover it with pea gravel, leaving only one end free to tuck into the other. Let it dry overnight before gluing it into place. Rather than staples, use tape to attach the “water” inside and glue to attach the figures outside the well.

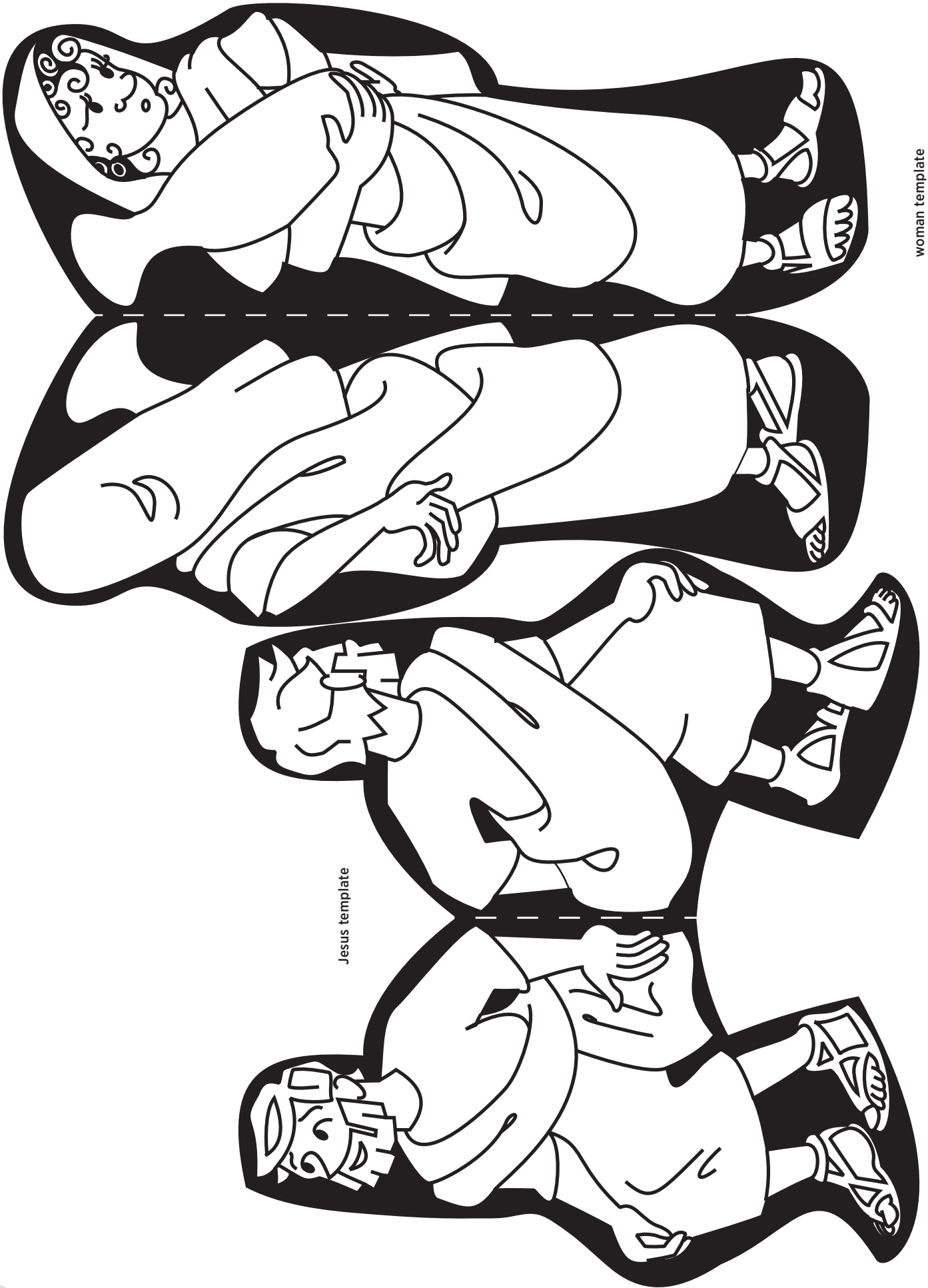

Jesus template

woman template





Whoever drinks of the water  
that I will give him will never  
be thirsty again. **JOHN 4:14 ESV**



stone well template

## JESUS TEACHES THE PARABLE OF THE SOWER

*Matthew 13:1-23; Mark 4:1-20; Luke 8:4-15*

Hear the word and accept it and bear fruit. (Mark 4:20)

### SUPPLIES:

(to make one craft)

- 1 sheet of white cardstock
- templates of the sower, birds, rock, and weeds (see page 165)
- crayons or markers
- scissors
- glue
- handful of sesame seeds, other small seeds, or fine, seed-like confetti

### INSTRUCTIONS:

**PREP STEP:** Copy the four templates onto white cardstock.

1. Color the sower, birds, rock, and weeds, and cut them out.
2. Accordion-fold the picture on the dotted lines to create panels as shown above.
3. Paste the birds, rock, and weeds onto their respective panels (they will be in descending height as you move away from the sower). Place the paste on the base of the panel rather than on the pictures, since only a part of the picture backs will cover the base.
4. Glue seeds into the sower's hand and onto each of the four other panels.
5. *Optional:* Cut out the illustrated verse and paste it to the back of the sower.

**MAKE IT SIMPLE:** Cut and crease ahead of time.





sower template



weeds template



Hear the word  
and accept it  
and bear fruit.  
**MARK 4:20 ESV**

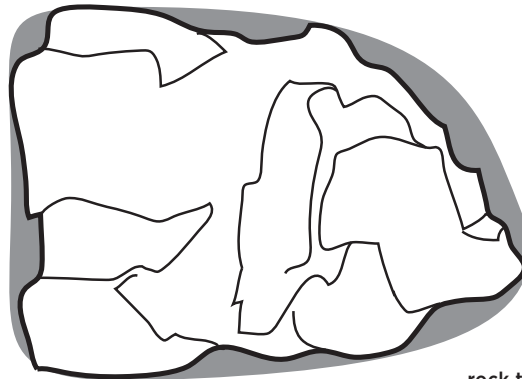

rock template



birds template

# JESUS RAISES LAZARUS FROM THE DEAD

John 11

Jesus said to her, "I am the resurrection and the life. Whoever believes in me, though he die, yet shall he live."  
 (John 11:25)

## SUPPLIES:

(to make one craft)

- 1 sheet of white cardstock
- templates of Lazarus (on a sliding rectangle), the stone cover, Jesus, and the tomb (see page 167)
- crayons or markers
- scissors and *optional* craft knife such as X-Acto™
- glue

## INSTRUCTIONS:

**PREP STEP:** Copy the four templates onto white cardstock.

1. Color Lazarus, the stone cover, Jesus, and the tomb and cut them out. Use a craft knife or scissors to cut out the opening in the tomb and to slit the vertical lines on either side of the opening. Fold the bottom section back on the dotted line to form a base.
2. Pass the rectangle containing Lazarus through both slits so that the ends of the rectangle are in front of the tomb as shown. Fold both end tabs inward on the dotted lines and crease well.
3. Paste the picture of Jesus to the tab on the right and paste the picture of the stone "door" to the tab on the left, aligning the left edge of the stone over the crease. When the slider is positioned on the right, Jesus is instructing the men to push away the stone. As you pull the slider to the left, the men move the stone away, Lazarus approaches the opening, and Jesus moves toward him.
4. *Optional:* Cut out and paste the illustrated verse to the back of your craft.



Step 1



Step 2

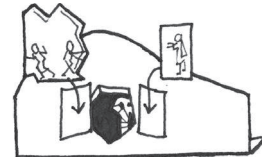

Step 3

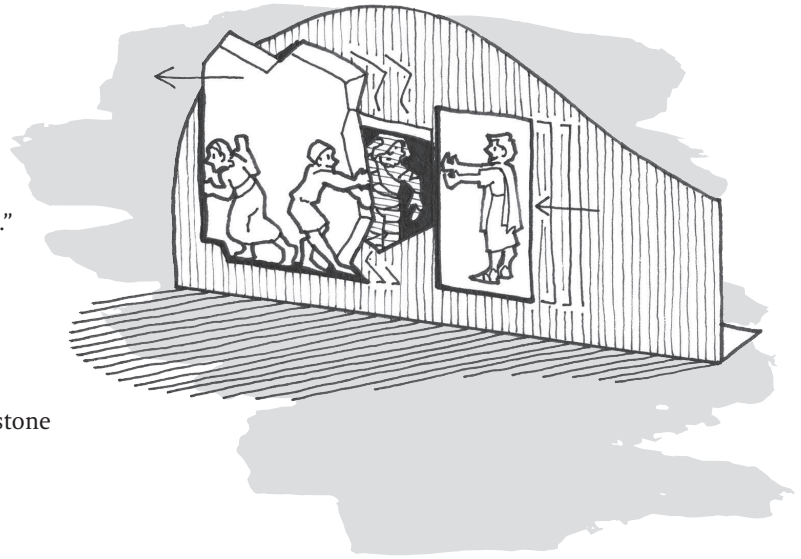

**MAKE IT SIMPLE:** Cut everything out ahead of time and crease. Paste the stone door and Jesus to the slider, but do not thread them through the slits before class. After coloring, students can pass the "Jesus" end down through the left slit, back up through the right, and then re-crease.

**MAKE IT AMAZING:** Construct the tomb out of a paper plate using hot glue and the instructions for "Craft 89: Jesus Is Alive!" but do not cut the door described in those instructions. Copy the template for Lazarus's tomb, tape it temporarily to your plate tomb, and use it to cut the slits and pentagon-shaped opening. Remove the template and insert the Jesus-and-Lazarus slider.

Lazarus template

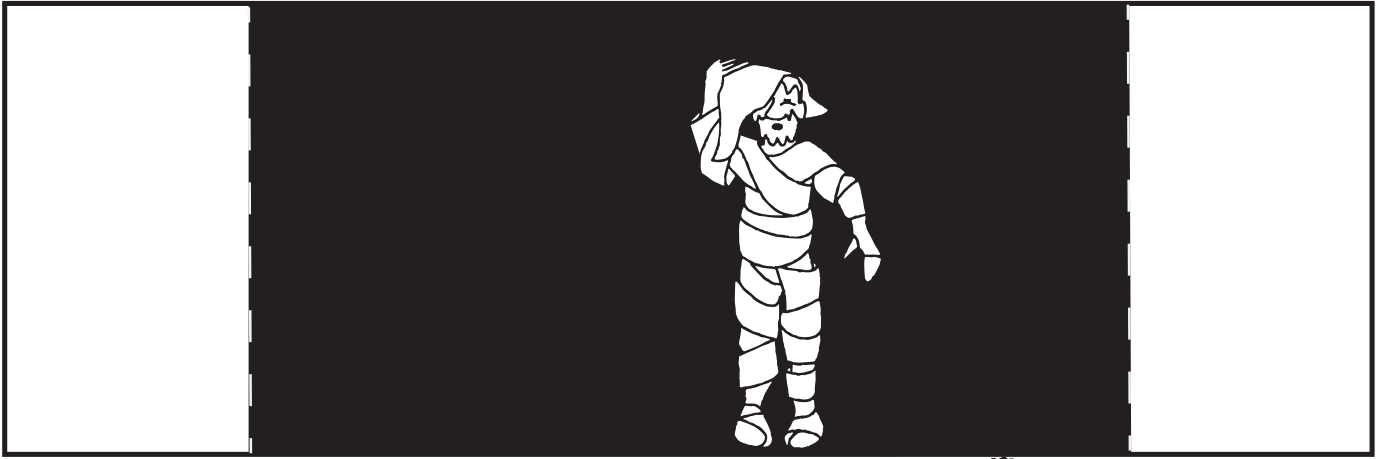

Jesus said to her, "I am the resurrection and the life. Whoever believes in me, though he die, yet shall he live." JOHN 11:25 ESV

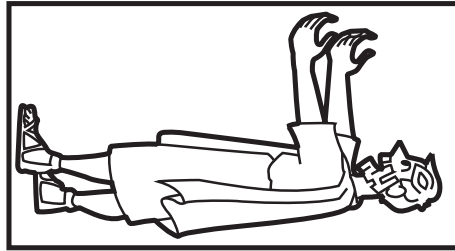
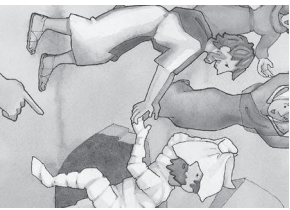

Jesus template

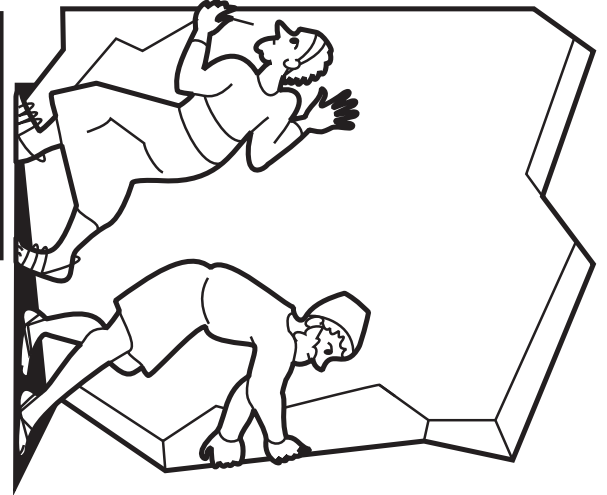

stone cover template

tomb template

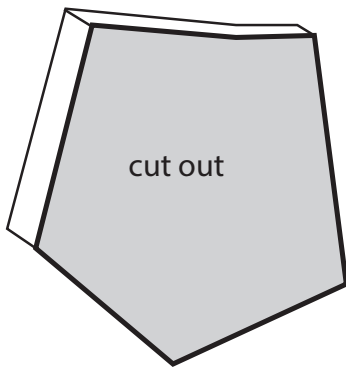

cut out

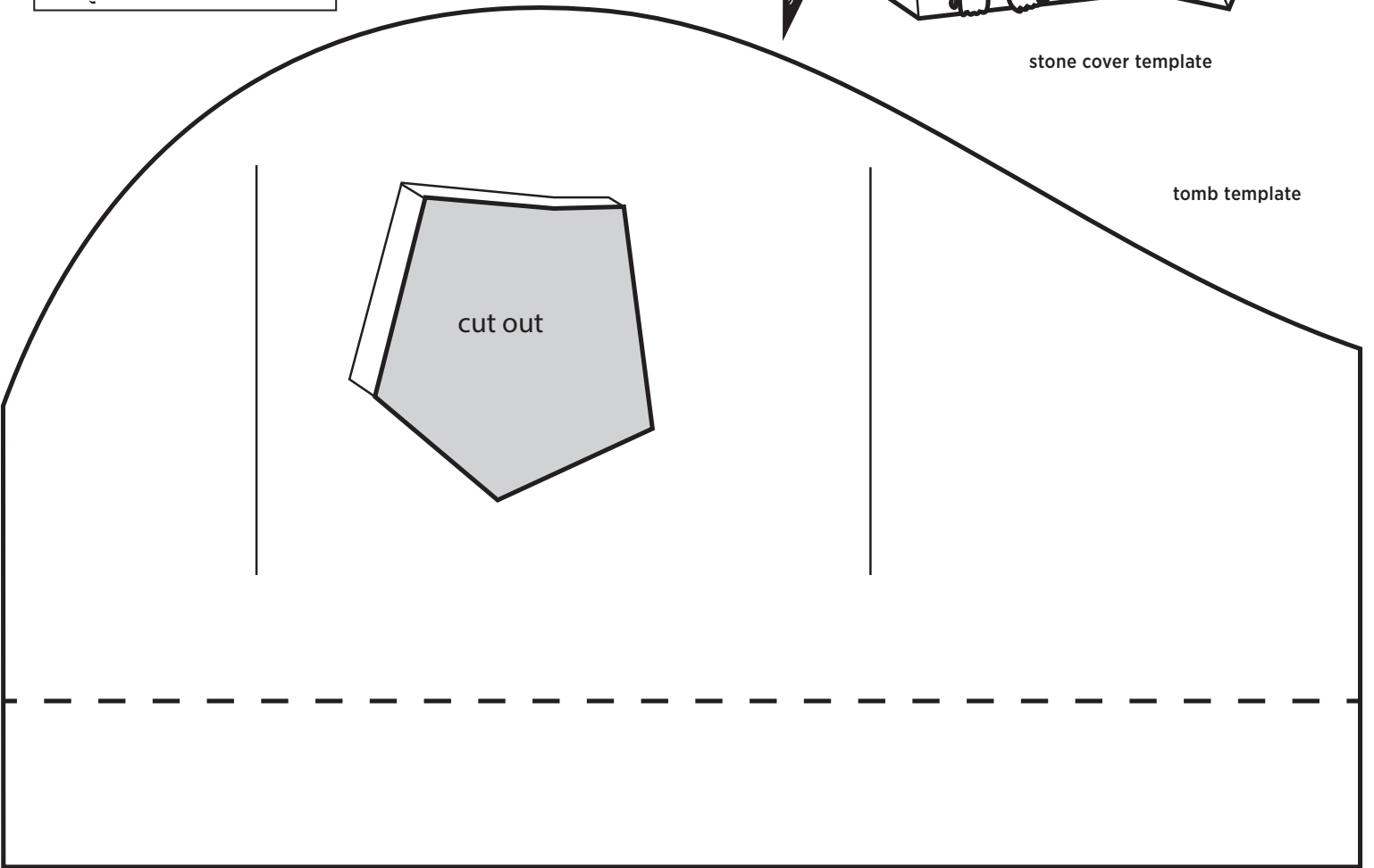

## JESUS TEACHES THE PARABLE OF THE WISE AND FOOLISH BUILDERS

*Matthew 7:24-27; Luke 6:46-49*

Everyone then who hears these words of mine and does them will be like a wise man who built his house on the rock. (Matt. 7:24)

### SUPPLIES:

(to make one craft)

- 2 sheets of white or tan cardstock
- templates of house and of sand and rock textures (see pages 169-70)
- a 5 ½ x 4 ¼-inch sheet of sandpaper
- scissors
- glue
- crayons or markers

### INSTRUCTIONS:

**PREP STEP:** Copy the house and textures templates onto white or tan cardstock.

1. Cut out the texture images. Glue a sheet of sandpaper over the sand photo and trim the edges.
2. Color the house picture. Cut it out, flip it over, and fold and crease inward on every dotted line. Glue the seven gray flaps to the adjacent wall inside the house as shown.

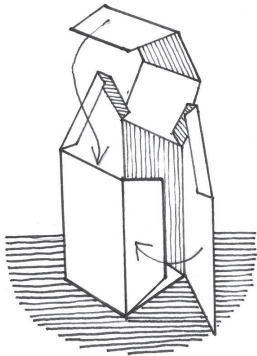

Step 2

3. Glue the house onto the “rock” side of the textured base.
4. *Optional:* Cut out the illustrated verse and glue it to your craft.

**MAKE IT SIMPLE:** Cut everything out ahead of time. Crease on the dotted lines, then open flat to color. *Alternatively,* use the two-dimensional house template instead of constructing the three-dimensional house.

**MAKE IT AMAZING:** Use a 12 x 12-inch natural slate tile from a home-improvement store for the base. Paint glue onto half of the top surface, cover it with fine dry sand, and shake off the excess sand when it is dry. Enlarge the house template when you copy it.

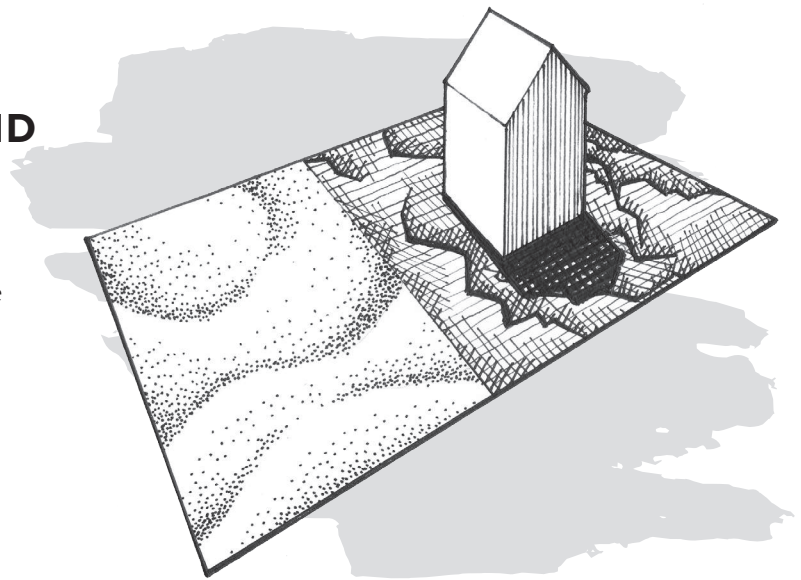



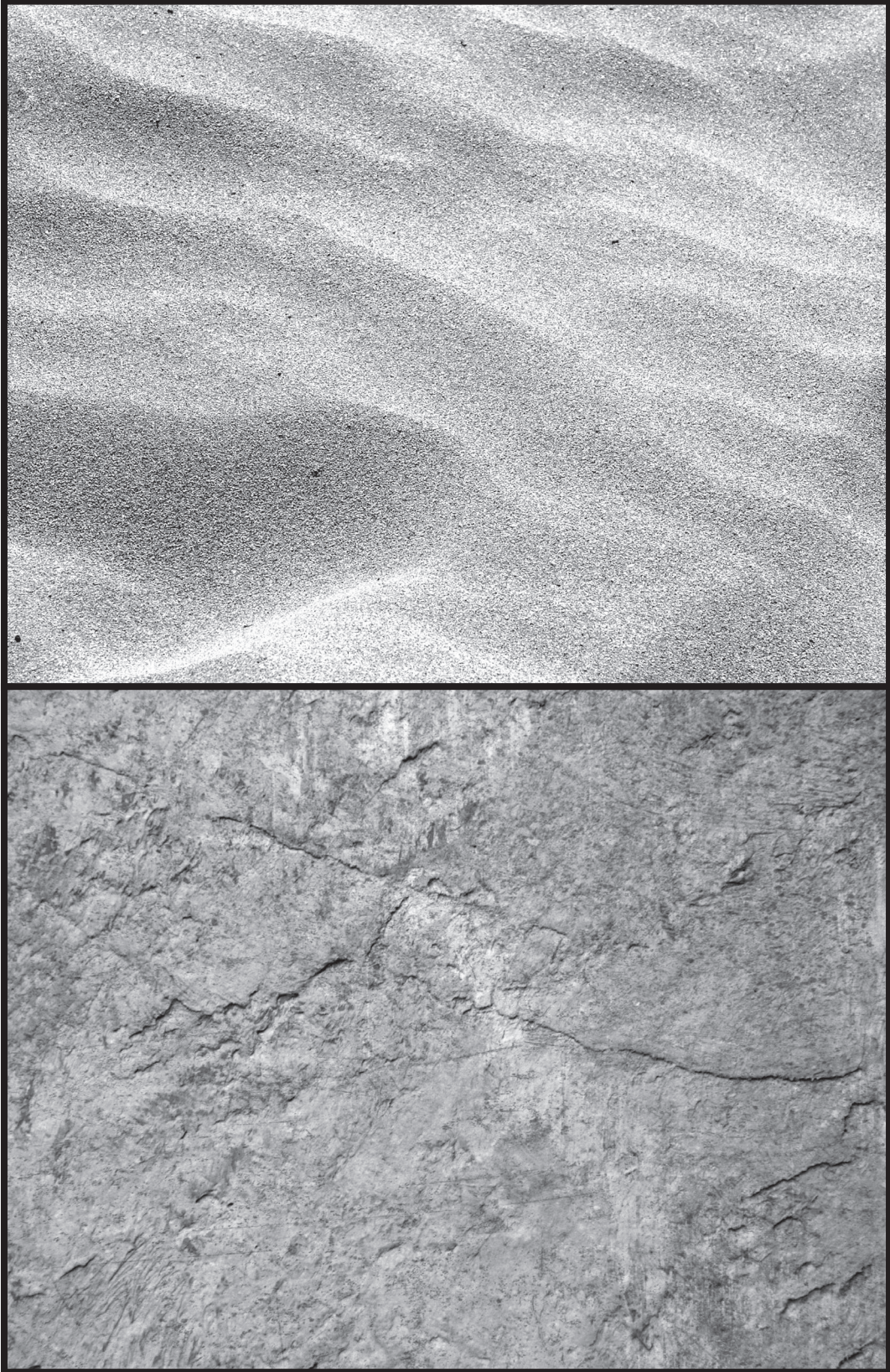

sand and rock template



Everyone then who hears these words of mine and does them will be like a wise man who built his house on the rock.

**MATTHEW 7:24 ESV**

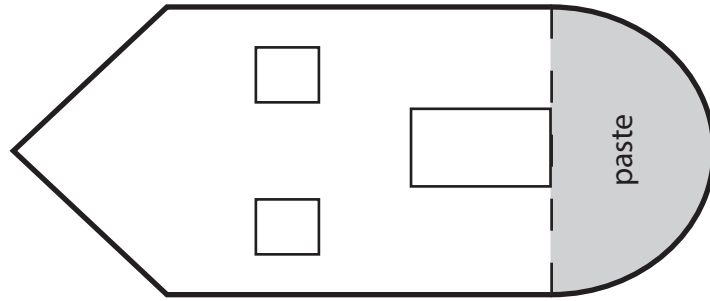

Make It Simple template

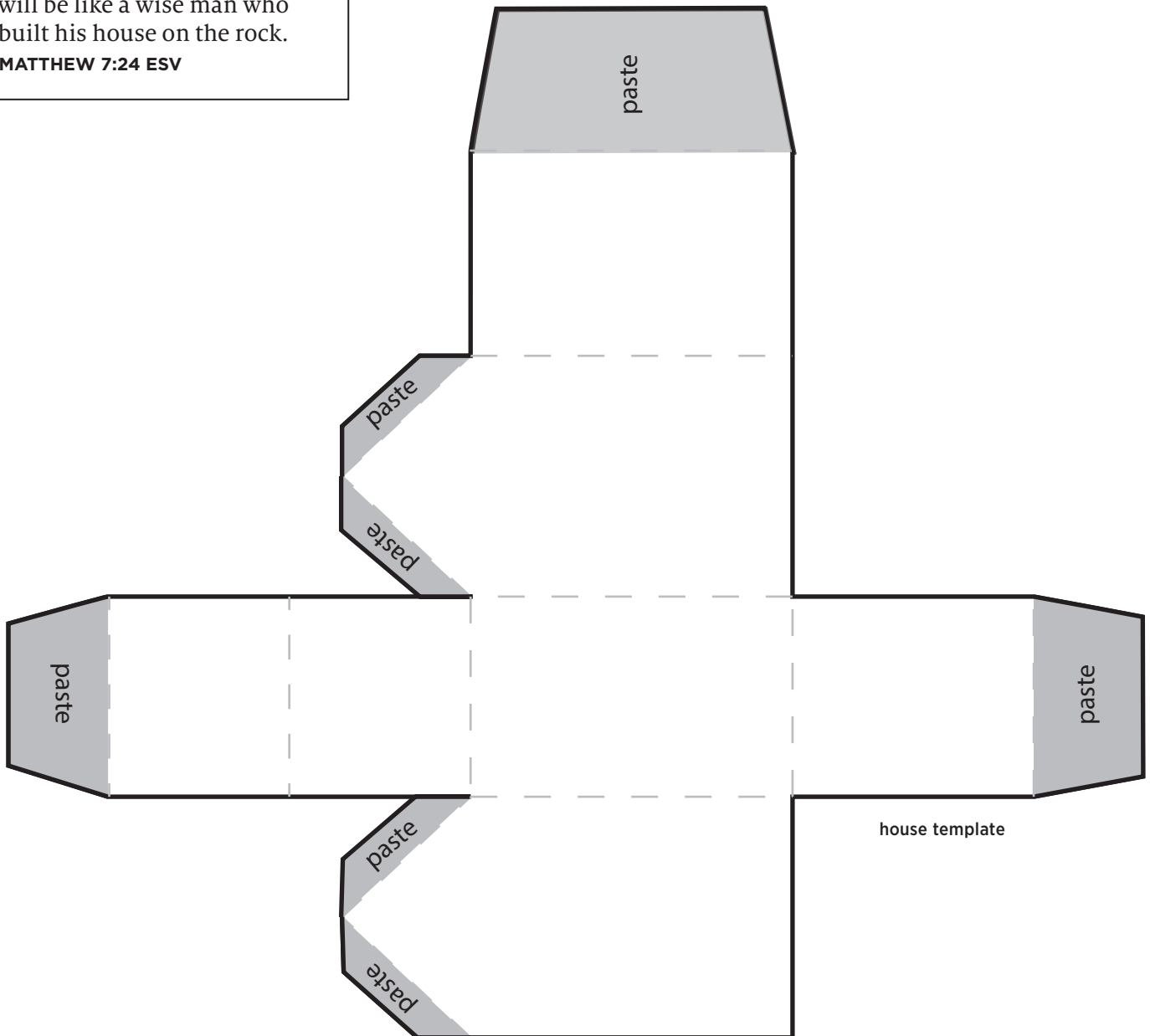



## JESUS PRAISES A POOR WOMAN

Mark 12:41-44; Luke 21:1-4

Each one must give as he has decided in his heart . . . for God loves a cheerful giver. (2 Cor. 9:7)

### SUPPLIES:

(to make one craft)

- 1 paper lunch sack
- scissors
- 32 inches of twine
- crayons or markers
- 4 x 2-inch strip of corrugated cardboard
- copper foil (sold with art and craft supplies) or aluminum foil
- pen
- template of Jesus observing the widow (see page 172)
- 1 sheet of white cardstock

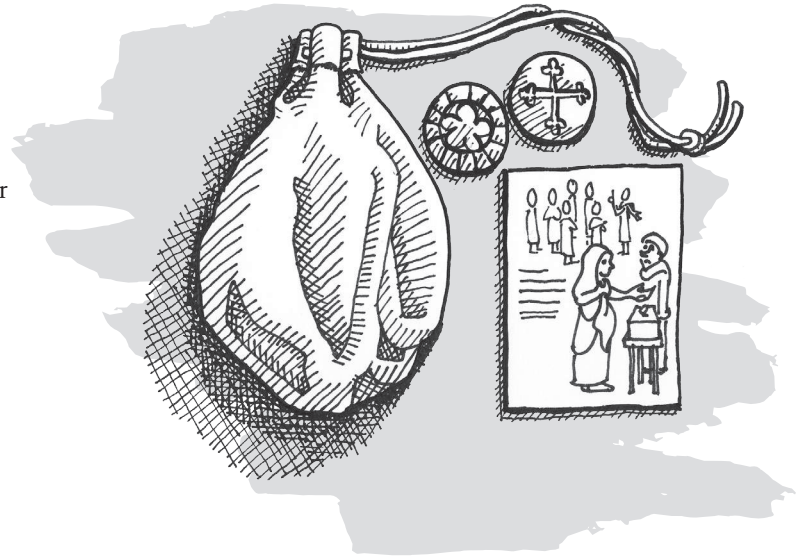

### INSTRUCTIONS:

**PREP STEP:** Copy the template of Jesus observing the widow onto white cardstock.

1. Crumple a paper lunch sack into a tight ball, open it back up, and re-crumple it until it is completely soft and pliable. Roll down the top 1 to 2 inches all the way around the opening and crease well. Use scissors to snip small slits centered in the rolled-down section, approximately 1 ½ inches apart, *making sure to cut an odd number of slits*.

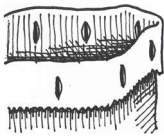

Step 1

2. Take one end of a 32-inch length of twine and thread it through one of the slits from the outside of the bag to the inside. Thread the same end through the next slit so that it is again outside the bag. You have now sewn a large stitch in the rim. Continue to thread the twine in and out of the slits all the way around the bag. By having cut an odd number of slits, you will end up inside the bag on the final slit. Now cut a new slit just a ½ inch from the first slit you entered and bring the twine end back outside the bag through that slit. Pull the twine through until both ends are of equal length and tie them together somewhere near their ends. You now have a money pouch that can be cinched closed. Color it as you wish.

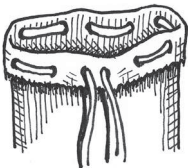

Step 2

3. Cut two 2-inch circles from corrugated cardboard. Cover them with copper foil, as the widow's coins were copper, or with aluminum foil. One side of each "coin" will be smooth, the other rough from the edges of the foil overlapping. Use a dull stylus such as a retracted pen to gently engrave words, pictures, or designs on the smooth faces of your coins.
4. Color and cut out the picture of Jesus observing the widow. Place it, along with the coins, inside the pouch.

**MAKE IT SIMPLE:** Construct the money pouches and cut out the coloring pictures and cardboard circles before class. Determine whether your students might be able to wrap their coins in foil by themselves, and prepare accordingly. Have styluses ready, and consider preparing photos of ancient Greek and Roman coins for inspiration.



Each one must give  
as he has decided  
in his heart . . . for  
God loves a  
cheerful giver.  
**2 CORINTHIANS 9:7 ESV**

Jesus observing the widow temple

## JESUS CALMS A STORM

*Matthew 8:23-27; Mark 4:35-41; Luke 8:22-25*

What sort of man is this, that even winds and sea obey him? (Matt. 8:27)

### SUPPLIES:

(to make one craft)

- a 6-inch paper plate
- scissors
- 2 sheets of white cardstock
- 1 long bamboo skewer
- hot-glue gun
- crayons or markers
- 1 sheet of blue paper
- tape
- gold or yellow glitter foam or metallic paper
- gray, white, or silver glitter foam or glitter glue
- glue
- optional: 1 sheet of copy paper
- optional: templates of waves, lightning-bolt, sail, and sun (see page 175)

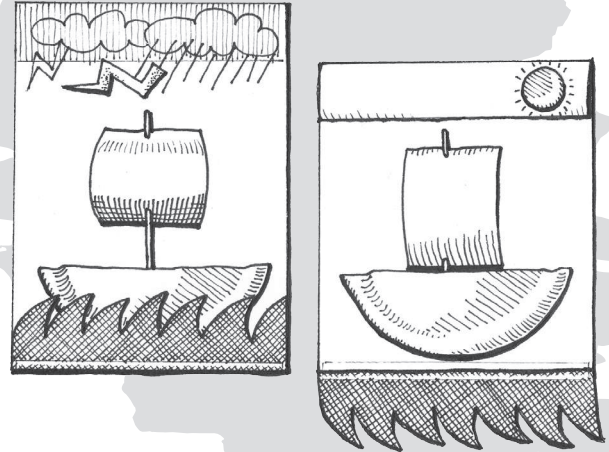

### INSTRUCTIONS:

**PREP STEP:** Optional for **Steps 3 and 4:** Copy the wave and lightning-bolt templates onto white paper to use as a pattern. Optional for **Step 5:** Copy the illustrated verse.

1. Make a boat by cutting off a section of paper plate 2 ½ inches deep. Use hot glue to fasten the boat by the rim of the plate to a full sheet of white cardstock in “portrait” position, centered a ½ inch above the bottom of the paper.

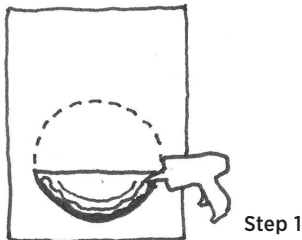

2. Make a sail by cutting a 3 x 4-inch rectangle from another sheet of cardstock (with or without using the template provided), then with an adult’s help, use the sharp end of a bamboo skewer to pierce the sail about a ½ inch from its top and bottom edges centering these holes on the 3-inch edges of the sail. Thread the skewer through the holes behind, then in front, of the sail to form a mast. Cut off the sharp end(s) of the skewer so that the remaining mast is about 6 inches long. Position the sail near the top of the mast, then hot glue the bottom of the mast far down inside the boat. Hot glue the top edge of the sail to the background sheet, just below the top of the mast. Now the sail can hang all the way down in calm weather and be scooped up the mast to billow out during fierce weather. Color the boat and sail.

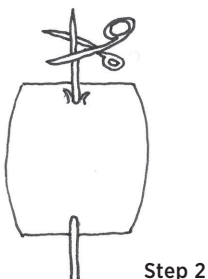

3. Cut an 8 ½ x 2 ½-inch rectangle from blue paper. Position it horizontally and cut wild, 2-inch waves from the top (with or without using the template provided). Using a long strip of tape behind both sheets of paper, tape the long straight edge of the blue paper to the bottom edge of the boat picture. Now the blue paper can flip up to make stormy water, and down to make calm water.

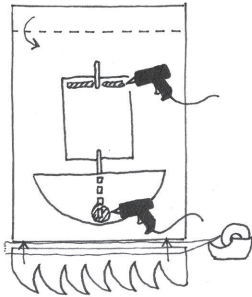

Steps 2, 3, and 4

4. Fold the top 1 ¾ inches of the picture down to form a long horizontal flap. Cut a 1-inch circle from gold or yellow glitter foam or metallic paper to make the sun. Glue the sun off-center onto the top of the flap when it is folded down. Raise the flap and draw gray and black clouds on its underside. Draw lines of rain coming from the clouds, but only an inch long so that they don't show when the flap is folded down. Cut jagged lightning bolts (with or without using the templates) from gray, white, or silver glitter foam or metallic paper and glue them diagonally just below the clouds (again, not low enough to be seen when the flap is lowered.) *Alternately*, create the lightning with glitter glue. Now when the flap is lowered, it is a bright calm day, and when the flap is raised, it is stormy.
5. *Optional*: Cut out the illustrated verse and paste it to the back of the craft.

**MAKE IT SIMPLE:** Cut out the boat, mast, and sail and hot glue them in place ahead of class. Cut out the strips of water, along with the suns and possibly the lightning bolts (make several of each at a time). Make sure you have sufficient gray and black crayons ready to go.

**MAKE IT AMAZING:** Draw the faces of the disciples and Jesus just above the edge of the boat.



wave template



sail template

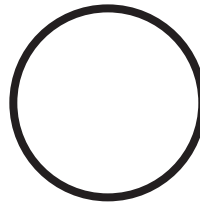

sun template

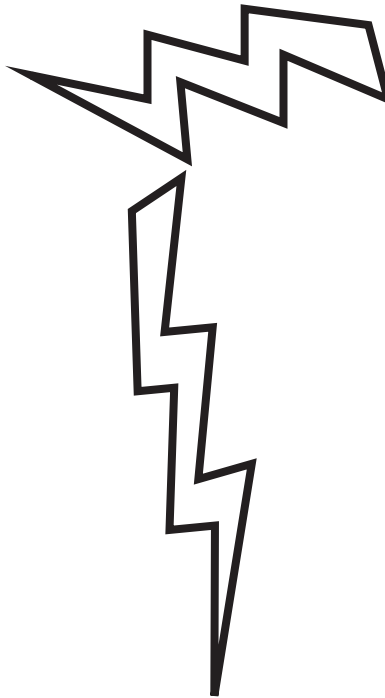

lightning bolt templates



What sort of man is this, that  
even winds and sea obey him?  
**MATTHEW 8:27 ESV**



## JESUS FEEDS A LARGE CROWD

*Matthew 14:13-21; 15:32-39; Mark 6:30-44; Luke 9:10-17; John 6:1-15*

Seek first the kingdom of God . . . and all these things will be added to you. (Matt. 6:33)

### SUPPLIES:

(to make one craft)

- 1 brown paper lunch sack
- scissors
- stapler
- optional: crayons or markers
- 3 to 5 stale pitas or template of five barley loaves (see page 179)
- 1 sheet of white or tan cardstock
- 1 sheet of metallic or other decorative paper or solid-colored paper
- templates of two fish (see page 178)
- optional: craft knife such as X-Acto™
- optional: 4 mini-cupcake liners
- optional: 4 hole-reinforcement stickers

### INSTRUCTIONS:

**PREP STEP:** Copy the fish templates onto copy paper (and use as a pattern), or copy directly onto a piece of solid-colored paper. *Optional for Step 3:* Copy the loaf templates onto white or tan cardstock.

1. Make a basket: Cut the top 5 inches off of a brown paper lunch sack. Open what is left of the bag and fold the top inch out and down all the way around, as if you were folding down a turtleneck. Crease, fold the rim out and down a second time, and crease again. This will stabilize your “basket” and help it stay open.
2. Create a basket handle from the part of the bag you cut off. Without cutting the remaining bag further, open and flatten the cut-off portion so that it is roughly 5 x 10 inches. Roll it or fold it several times lengthwise so that it is still 10 inches long but now only 1 to 2 inches wide. Staple the ends of your handle inside the rim of your basket on opposite sides as shown. Color the basket if you wish.

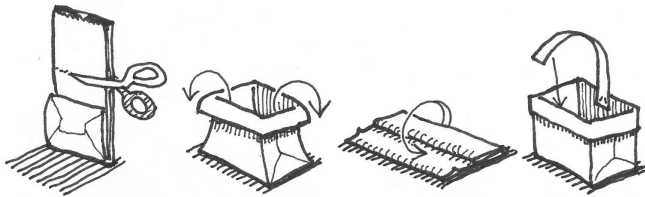

Steps 1 and 2

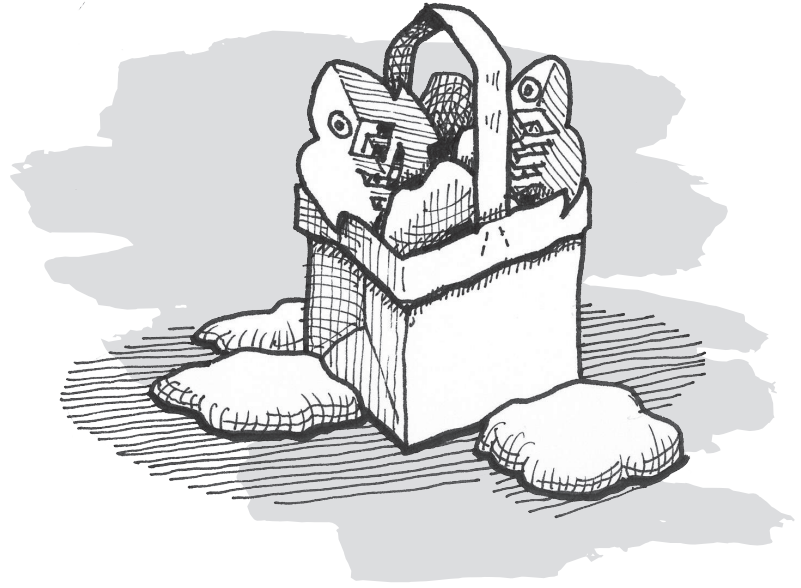

3. If you have three pitas, cut five 3-inch circle “loaves” from them. *Otherwise*, cut out the loaf pictures and color them if you wish.
4. Use the fish pictures as patterns to cut fish shapes from metallic and/or decorative papers, or, if you copied the templates directly onto solid-colored paper, simply cut the fish out. Use a craft knife or scissors to cut the gill slits (the six solid horizontal lines). Fold the fish lengthwise, about where the dotted line falls on the templates. Unfold the fish and reverse the creases on every other gill bar so that they pop out from the rest of the fish. *Optional*: Fold a few mini-cupcake liners in half, flattening them a bit, and staple them to either side of the fish as additional fins. Stick hole-reinforcement tabs to both sides of the fish as eyes.



Step 4

5. Place your five loaves and two fish in your basket as if they were ready to be miraculously divided to feed a hungry crowd.
6. *Optional*: Cut out the illustrated verse and paste it to the basket.

**MAKE IT SIMPLE:** Assemble the baskets and loaves before class, but let the students decorate and color them. Cut out the fish and skip the gills if you are pressed for time. Have students color the fish and choose where to glue the fins and stick the eyes.

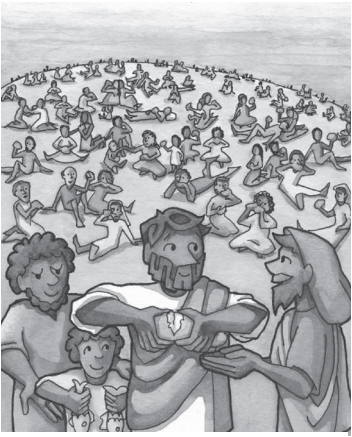

Seek first the kingdom  
of God . . . and all these  
things will be added to you.  
**MATTHEW 6:33 ESV**

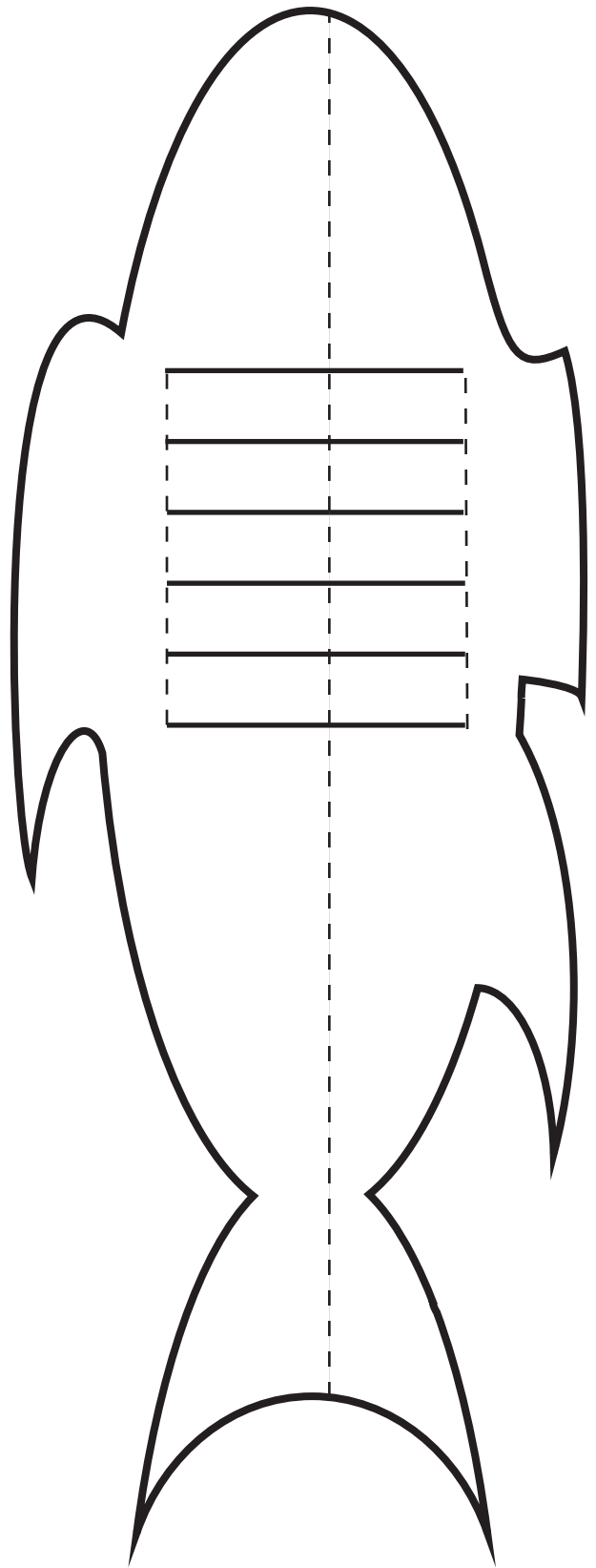
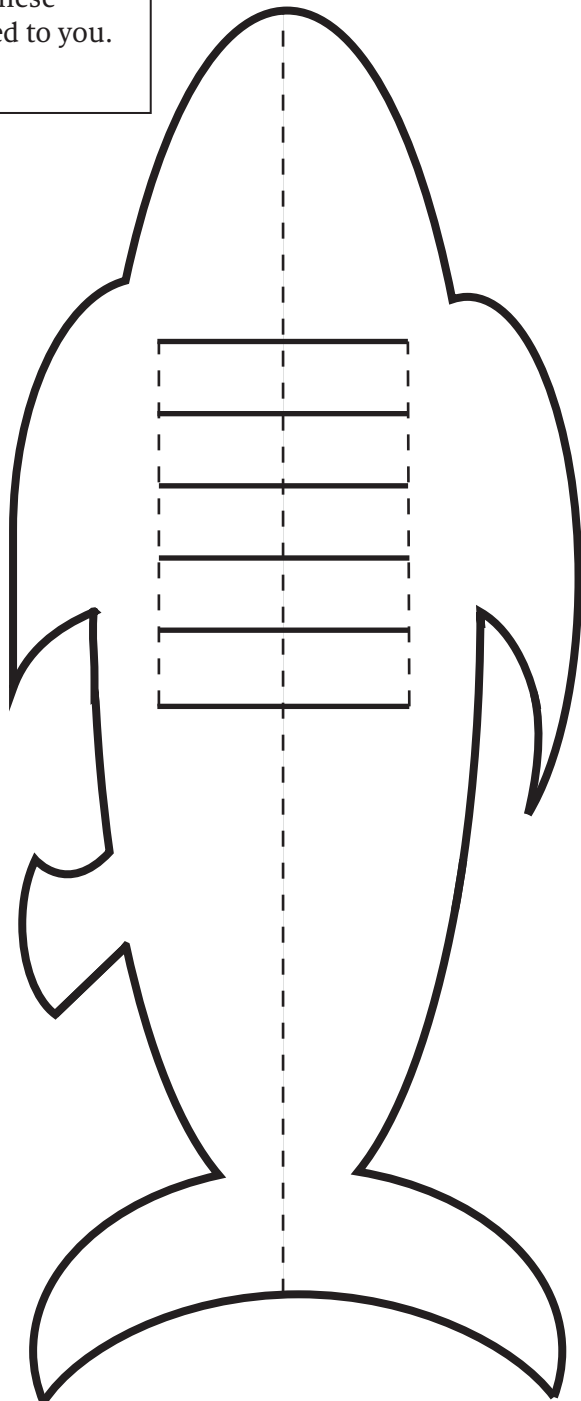

fish templates

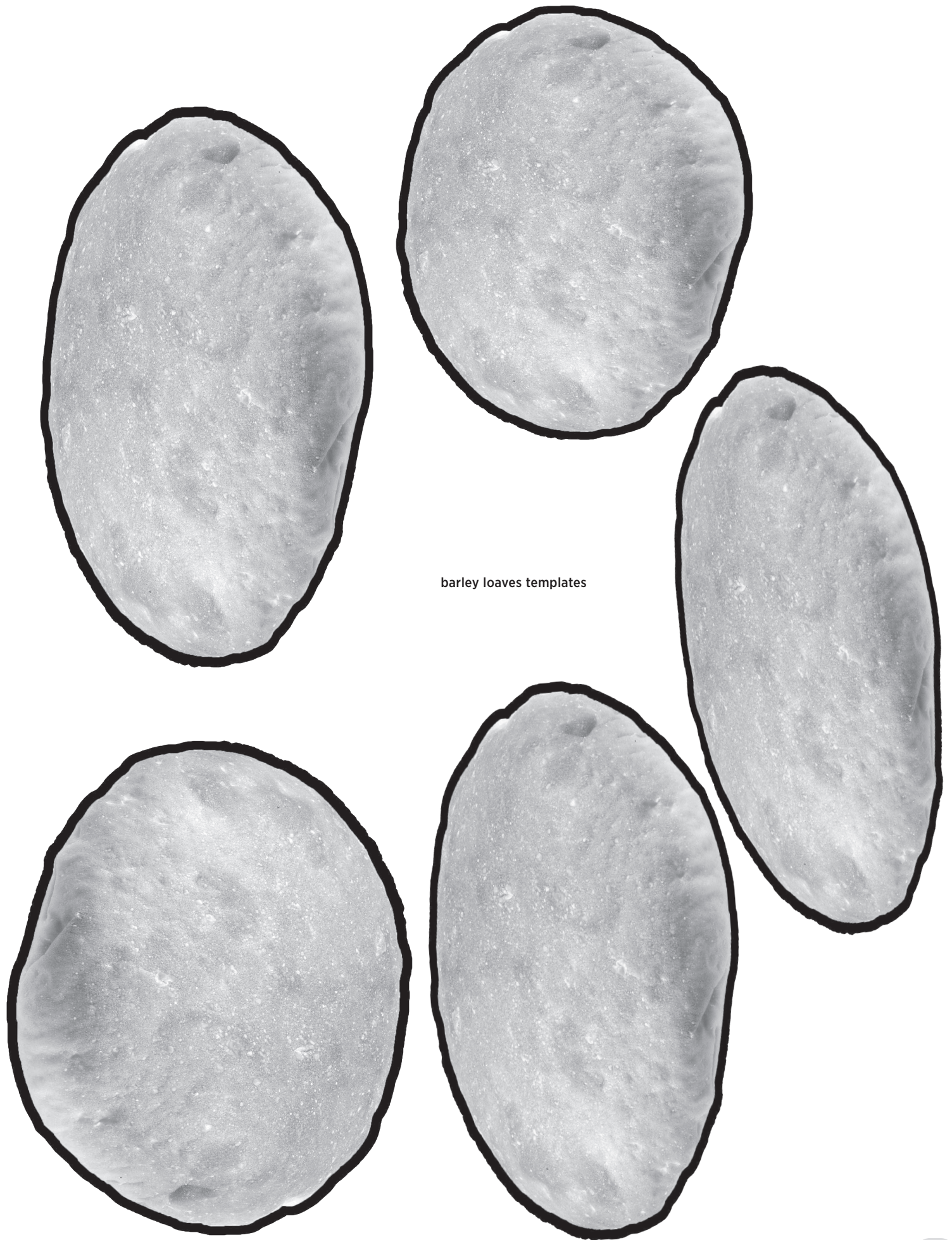

barley loaves templates



## JESUS REVEALS HIS GLORY

*Matthew 17:1-13; Mark 9:2-8; Luke 9:28-36*

This is my beloved Son, with whom I am well pleased; listen to him. (Matt. 17:5)

### SUPPLIES:

(to make one craft)

- 2 sheets of white cardstock
- templates of the mountain scene (the full page) and of Moses/Jesus/Elijah (see pages 180–81)
- crayons or markers
- metallic-silver paper or aluminum foil
- scissors and *optional* craft knife such as X-Acto™
- glue
- tape

### INSTRUCTIONS:

**PREP STEP:** Copy the Moses/Jesus/Elijah template and the full-page mountain-scene template onto white cardstock.

1. Color Peter, James, John and the scenery and cut out the transfigured Moses/Jesus/Elijah piece.
2. Use scissors or a craft knife to cut the large light-burst shape out of the scenery. Glue or tape the metallic paper or aluminum foil behind the mountain picture, shiny side up, to completely fill the hole you just cut out. Glue the three transfigured men in the center of the metallic light burst. Now the disciples are witnessing the transfiguration of Jesus.

**MAKE IT SIMPLE:** Cut everything out ahead of time, unless students have adequate scissor skills, in which case they can cut out the smaller light-burst shape with the men inside. Have tape on hand in case the foil does not easily adhere with glue.

**MAKE IT AMAZING:** Cut along the lines of only half of the light-burst shape in the side of the mountain, and fold that half back to form a flap. Glue the unprinted side of the flap onto aluminum foil, and when it is dry, trim away the excess along the edges so that your flap is completely “printed mountain” on one side and completely foil on the other side. Glue or tape more foil to the back side of the picture to fill the hole created when the flap is lifted. Open the flap all the way, place the transfigured men in the silver light burst, partially on the back side of the flap and partially on the foil covering the gap, glue them there, and crease them by closing the flap with them inside. Now when you close the flap, there is only an empty mountain, and when you open the flap the three figures appear suddenly in a burst of light.

*Alternately,* reduce the size of both templates to fit onto a flat-bottomed rock. Color and cut out the disciples and glue them to the bottom of the front edge of the rock. Cut out the transfigured men, glue them to foil or metallic paper, cut out another light-burst shape around them, and glue both layers to your rock.

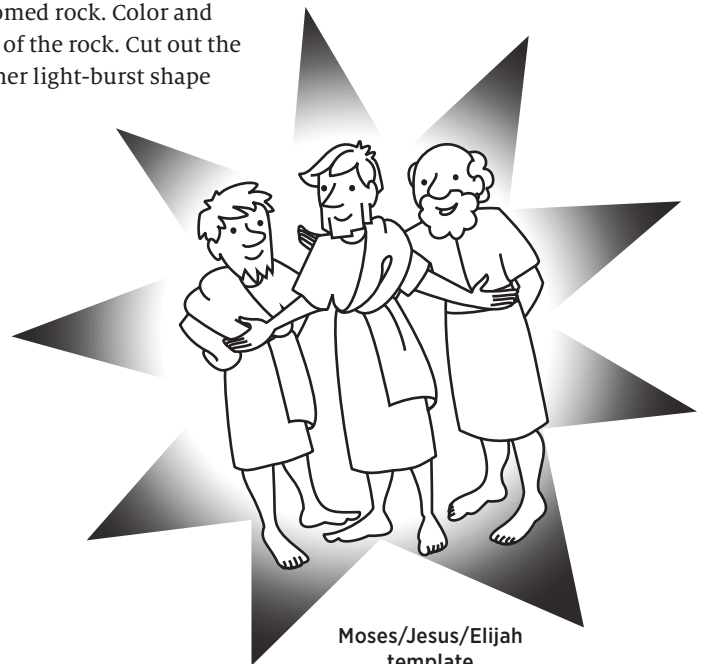

Moses/Jesus/Elijah  
template



This is my beloved Son, with whom  
I am well pleased; listen to him.  
MATTHEW 17:5 ESV



## JESUS TELLS THE STORY OF THE GOOD SAMARITAN

*Luke 10:25-37*

You shall love your neighbor as yourself. (Lev. 19:18)

### SUPPLIES:

(to make one craft)

- 1 sheet of skin-colored cardstock
- template of robbery victim (see page 183)
- crayons or markers
- scissors
- red marker
- white first-aid tape, ½ to ¾-inch wide, such as Nexcare™ or Johnson & Johnson™

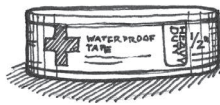

example of first-aid tape needed



### INSTRUCTIONS:

**PREP STEP:** Copy the template of the robbery victim onto skin-colored cardstock.

1. Use a red marker to create some simple wounds on the victim's forehead and limbs. Color the man and cut him out.
2. Pretend you are a good Samaritan helping your neighbor, and wrap strips of self-adhesive first-aid tape around the victim's head and limbs to bind up his wounds.
3. *Optional:* Cut out the illustrated verse and paste it to the victim's back.

**MAKE IT SIMPLE:** Cut out the figures and add their wounds ahead of time. Measure out three-to-four strips of first-aid tape for each student and stick them to the edge of each student's workspace.

**MAKE IT AMAZING:** Use the template as a pattern to cut a tunic for the man from stiffened felt, front and back, and glue it on him as well.



You shall love your neighbor as yourself.  
**LEVITICUS 19:18 ESV**

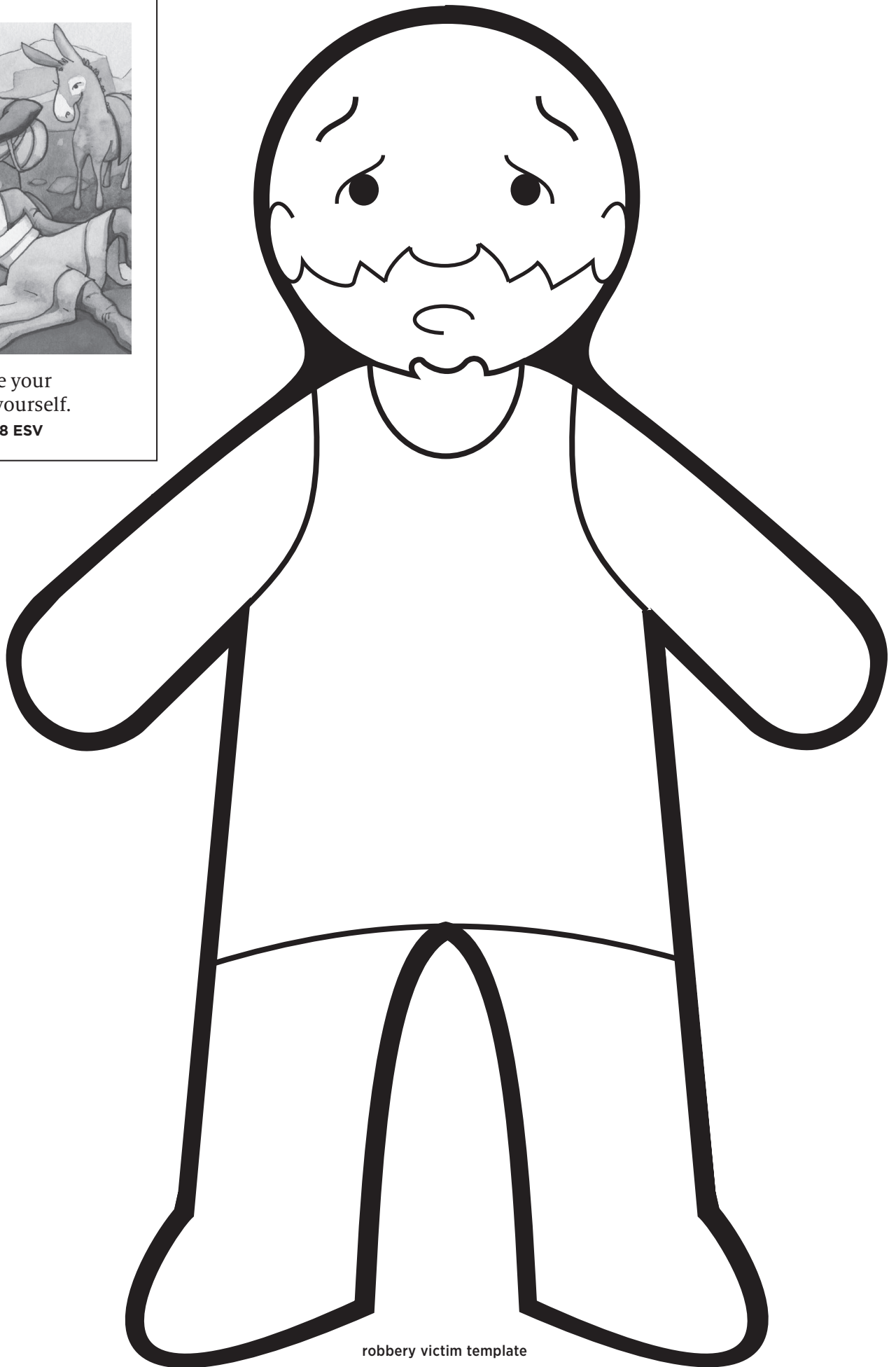

robbery victim template



## JESUS BLESSES THE CHILDREN

*Matthew 19:13-15; Mark 10:13-15; Luke 18:15-17*

Let the children come to me, and do not hinder them, for to such belongs the kingdom of God. (Luke 18:16)

### SUPPLIES:

(to make one craft)

- 1 sheet of white cardstock
- 2 sheets of copy paper
- templates of Jesus with children, two sets of additional children, and two disciples (see pages 185-87)
- crayons or markers
- scissors
- glue

### INSTRUCTIONS:

**PREP STEP:** Copy the full-page template of Jesus with children onto white cardstock. Copy the disciples and additional children onto copy paper.

1. Color the large pictures and cut out the disciples and the additional children.
2. Cut out the three-paneled piece, then fold the side panels inward on the dotted lines. Paste a picture of a disciple onto each of the two panels that are now visible. Unfold the paper and paste a set of additional children on either side of Jesus. When you close the folds, the disciples are rebuking the parents who want to bring their children to Jesus. When you open the folds, Jesus has invited the children to come to him.
3. *Optional:* Cut out the illustrated verse and paste it to the back of your picture.

**MAKE IT SIMPLE:** Cut and crease ahead of time.

**MAKE IT AMAZING:** Draw additional children behind those already in the picture, and perhaps their pleased parents looking on. Consider adding a drawing of yourself with the additional children.



Jesus with children template

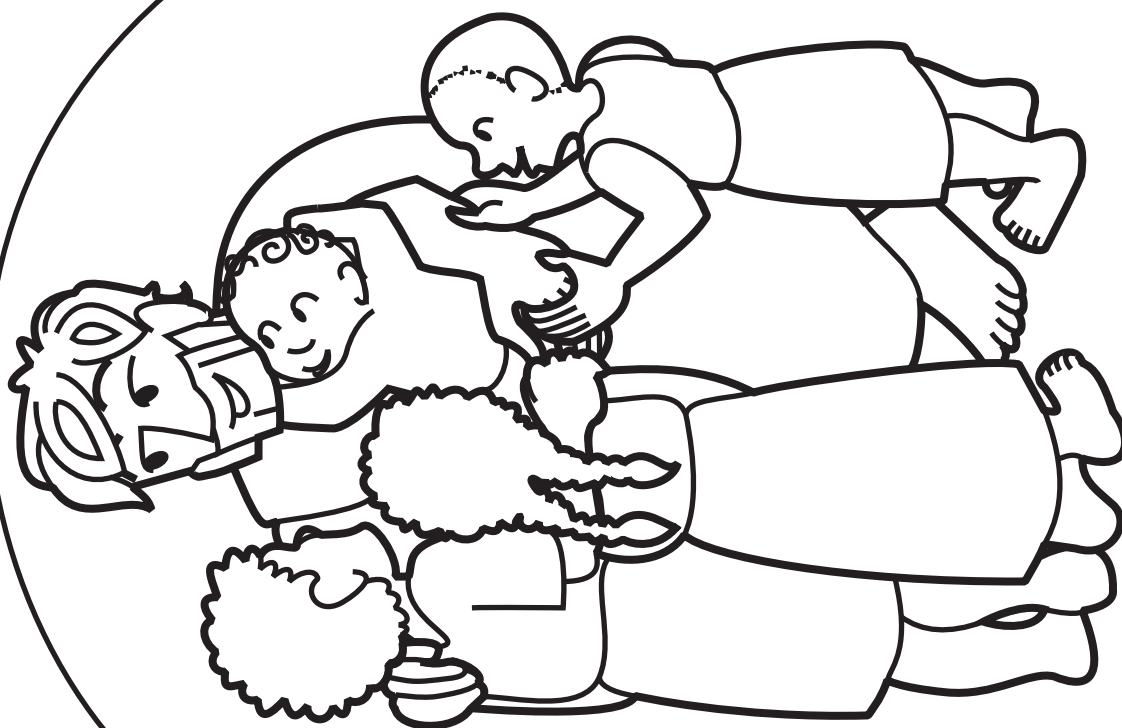





disciple templates



additional children  
templates

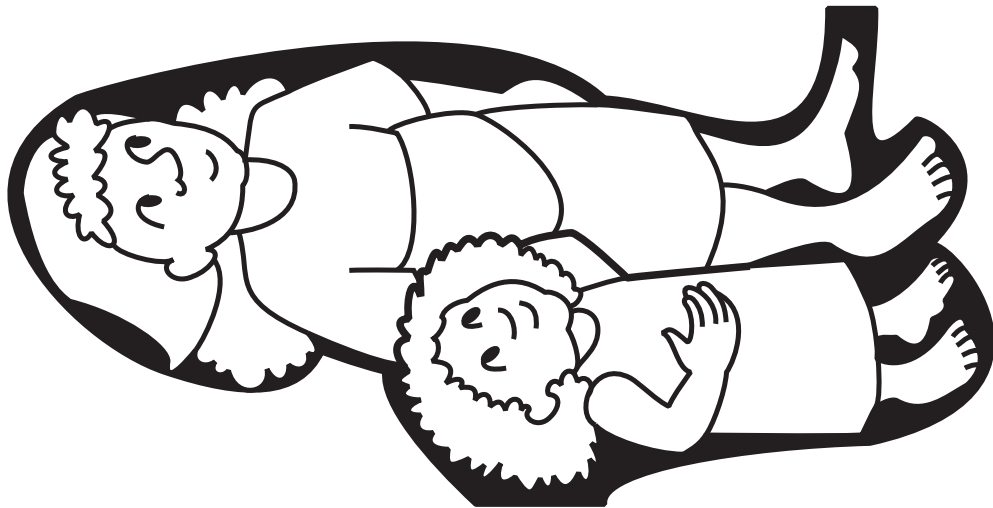

Let the children come to  
me, and do not hinder  
them, for to such belongs  
the kingdom of God.

**LUKE 18:16 ESV**

## JESUS (AND PETER) WALK ON WATER

*Matthew 14:22-33; Mark 6:45-51; John 6:16-21*

Truly you are the Son of God. (Matt. 14:33)

### SUPPLIES:

(to make one craft)

- 2 sheets of white cardstock
- templates of Peter and Jesus (see pages 189–90)
- crayons or markers
- scissors and *optional* craft knife such as X-Acto™
- glue
- 1 popsicle stick or bamboo skewer
- tape
- 1 sheet of blue cardstock or paper

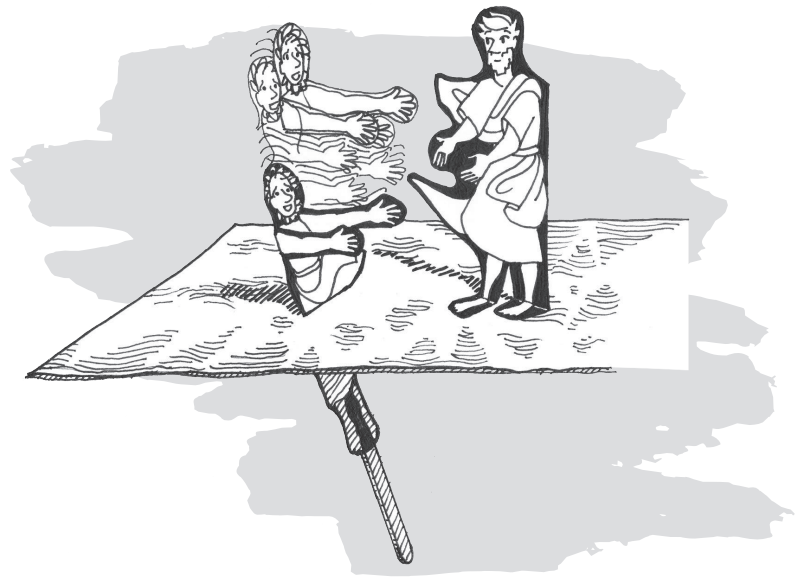

### INSTRUCTIONS:

**PREP STEP:** Copy the templates of Peter and Jesus onto white cardstock.

1. Color Peter and Jesus. Fold each in half on the dotted line before cutting each out. Glue the Jesus figure closed (front glued to back), then cut the slit to separate his legs. Fold his feet up 90 degrees on the dotted lines. Place the top few inches of a popsicle stick or bamboo skewer between the front and back halves of Peter, tape it in place, and then glue Peter closed with the stick inside. Fold his arms forward 90 degrees on the dotted lines.
2. Cut a sheet of blue cardstock in half crosswise, or fold a sheet of blue paper in half crosswise, and glue it closed to become “water.”
3. Put glue on the bottom of Jesus’s feet, then press them down onto the water with his right foot a bit in front of his left, as though he were taking a step. This will keep him standing upright. Press the feet in place until the glue is dry. Mark a spot on the water about 2 inches from Jesus on his right side. Make that spot a 1 ¼-inch long line almost perpendicular to Jesus. Cut that line with a craft knife or scissors and thread Peter’s handle down through the slit. Now you can make Peter sink and rise as he doubts and Jesus saves him.
4. *Optional:* Cut out the illustrated verse and paste it to the water.

**MAKE IT SIMPLE:** Fold, cut out, and paste the figures closed before class. You may need to slit the water papers ahead of time as well. If class time is short, you could skip the Peter figure altogether.

**MAKE IT AMAZING:** Cut a few 2-inch-wide strips of blue cardstock or paper, and cut tall triangular wave shapes from the long side as shown. Curl the waves around a pencil, then arrange the strips on the water so that the waves are “blown” the same direction as Jesus’s and Peter’s clothing. If there is room, cut the edges of the water paper itself into tall waves as shown and curl them like the others.

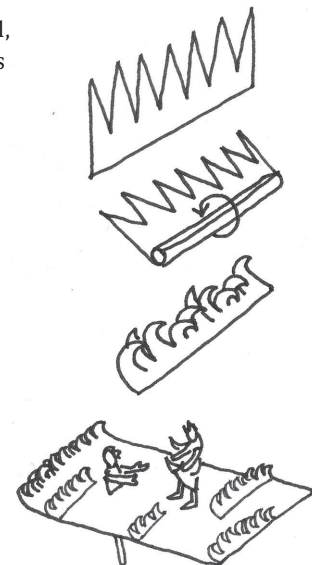

Make It Amazing



Truly you are  
the Son of God.  
**MATTHEW 14:33 ESV**



Jesus template

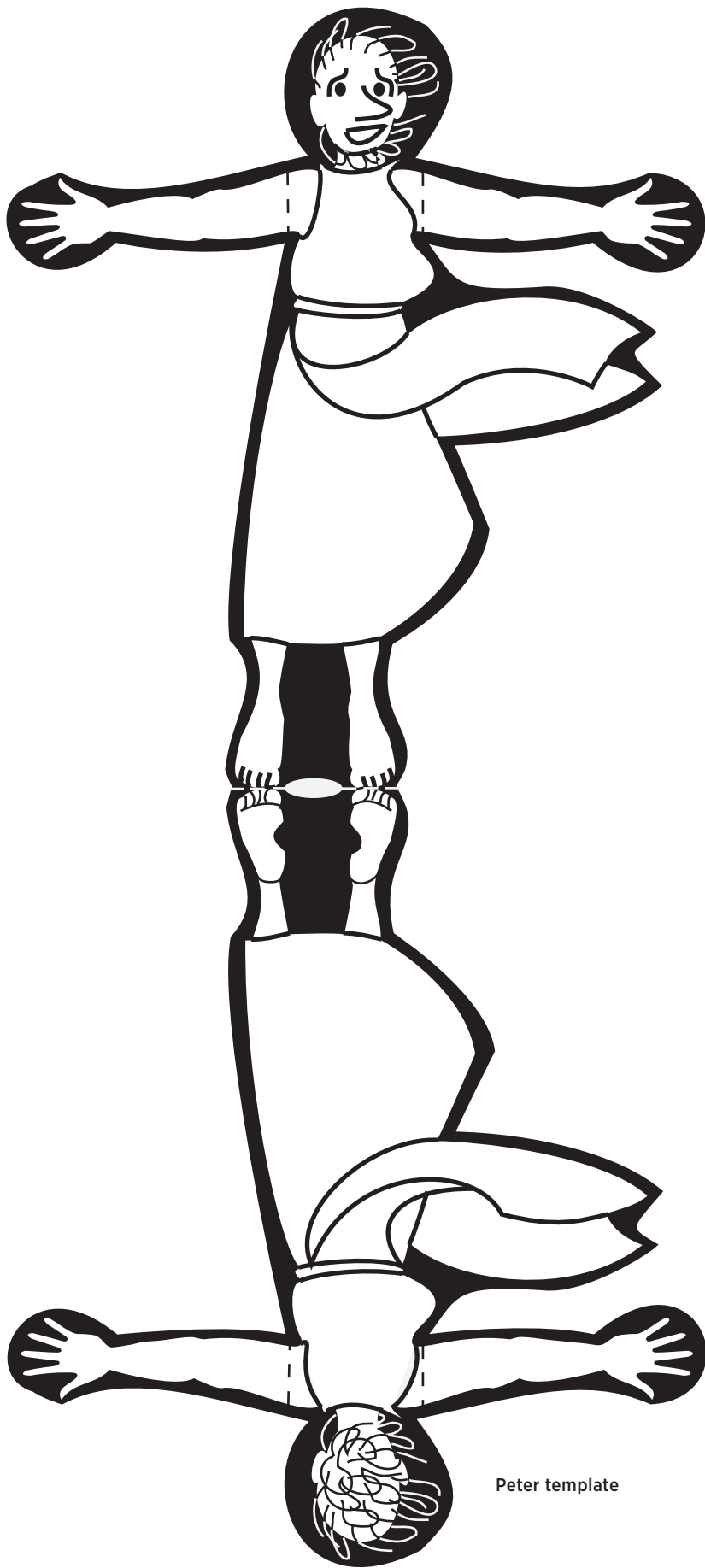

Peter template



## JESUS VISITS MARY AND MARTHA

Luke 10:38-42

The LORD gives wisdom; from his mouth come knowledge and understanding. (Prov. 2:6)

### SUPPLIES:

(to make one craft)

- 2 sheets of white cardstock
- templates of Jesus, Mary, Martha, and stand (see pages 192-93)
- crayons or markers
- scissors
- glue

### INSTRUCTIONS:

**PREP STEP:** Copy the people and stand templates onto white cardstock.

1. Color the three figures and cut out all pieces.
2. Fold the stand according to the illustration: First in half lengthwise so that the printed side is out, then back and forth on the dotted lines as illustrated. This is simply an accordion fold, except for the very last, triangle-shaped section.
3. Paste the three figures onto the designated sections of the stand, following the outlines provided. Put the paste on the shaded areas of the stand rather than on the figures, because most of each figure will not be glued down. Mary will be seated at Jesus's feet, and Martha will be looking over his shoulder.
4. *Optional:* Cut out the illustrated verse and glue it to the back of Jesus.

**MAKE IT SIMPLE:** Cut out all pieces ahead of time, and make the folds on the stand.

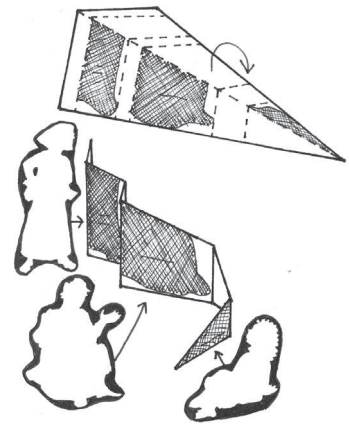

Steps 2 and 3

Mary template



Jesus template

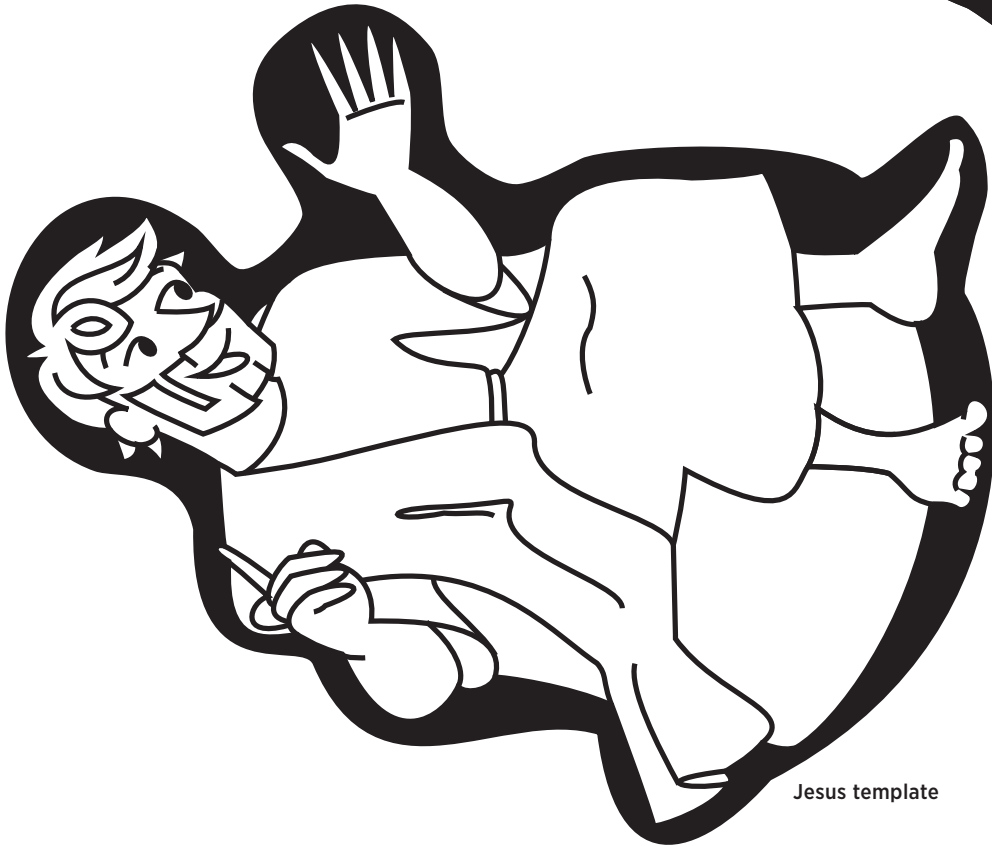

Martha template



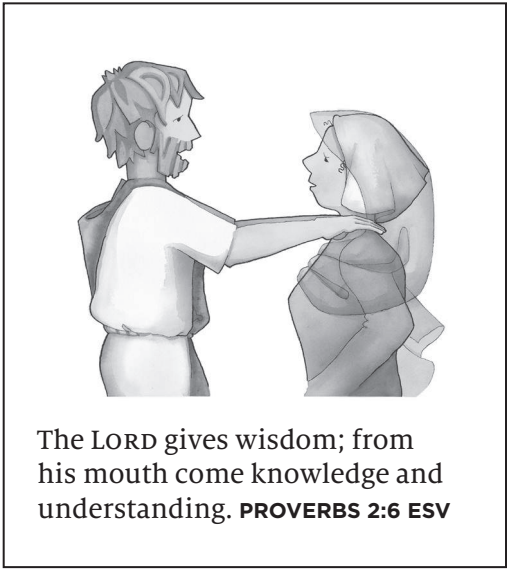

The LORD gives wisdom; from his mouth come knowledge and understanding. **PROVERBS 2:6 ESV**

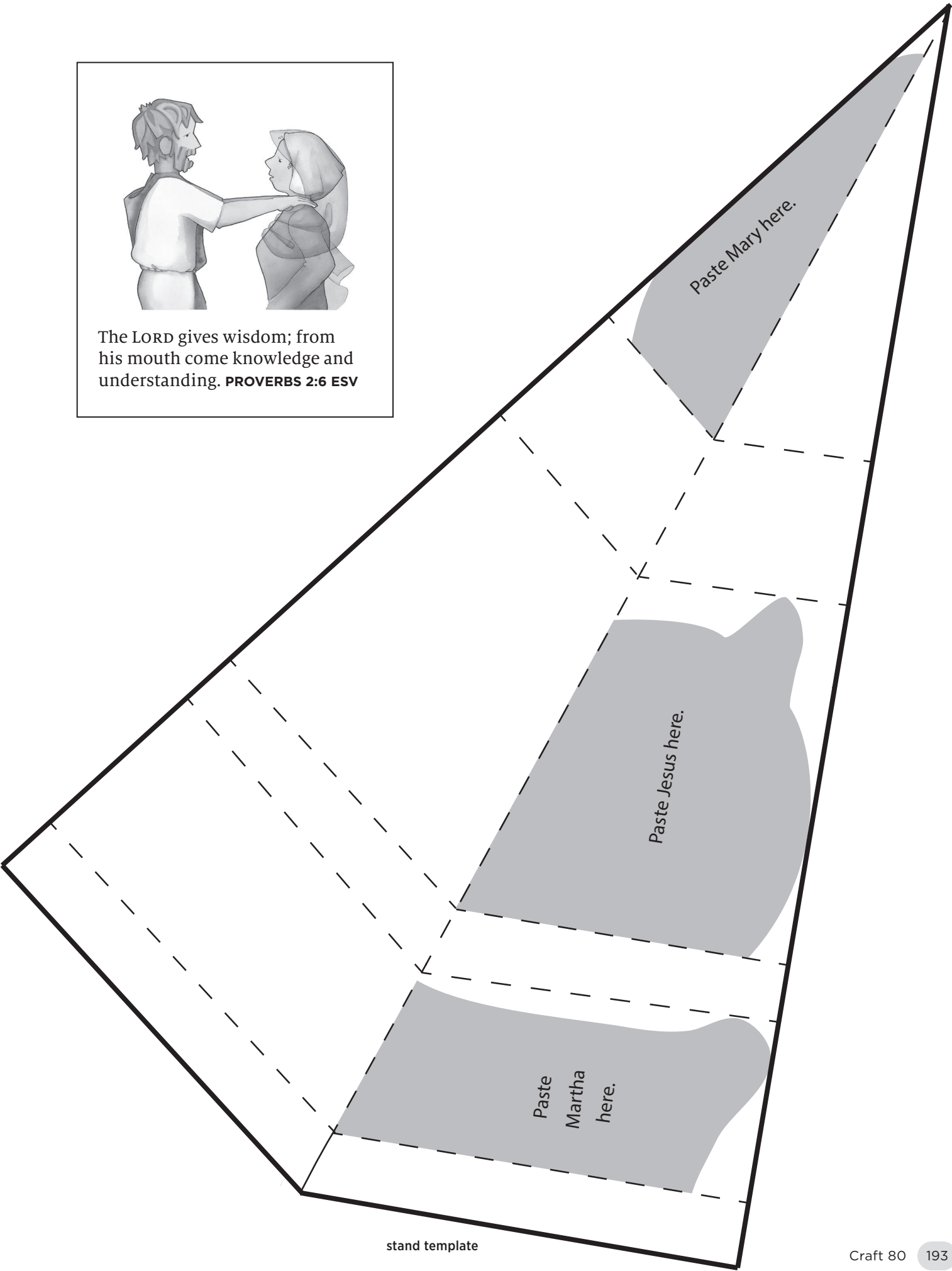

stand template

## JESUS TELLS THE PARABLE OF THE PRODIGAL SON

Luke 15:11-32

Just so, I tell you, there is joy before the angels of God over one sinner who repents. (Luke 15:10)

### SUPPLIES:

(to make one craft)

- 2 sheets of white cardstock
- templates of the full-page story and the small prodigal son (see pages 194-95)
- crayons or markers
- scissors
- craft knife such as X-Acto™
- 1 bamboo skewer or popsicle stick
- glue

### INSTRUCTIONS:

**PREP STEP:** Copy the prodigal son template and the full-page template of his story onto white cardstock.

1. Color the pictures and cut out the prodigal son image. With an adult's help, use a craft knife to cut along the long straight diagonal line in the larger picture.
2. Fold the small square in half along the dotted line and glue it closed around one end of a bamboo skewer. This creates a tiny double-sided puppet on a long stick. Cut off the sharp end of the skewer.
3. Poke your puppet up through the slit and move him about using the long handle. "Walk" him, with his happy side showing, from his home, through "reckless living," to the pigpen. Then turn his sad side up and walk him home again, where he becomes happy once more.
4. *Optional:* Cut out the illustrated verse and glue it to the craft.

**MAKE IT SIMPLE:** Cut the slits and remove the sharp ends of the bamboo skewers ahead of time.

**MAKE IT AMAZING:** Before you color, use a black pen to add your own small, foolish, and money-wasting characters to the scene.

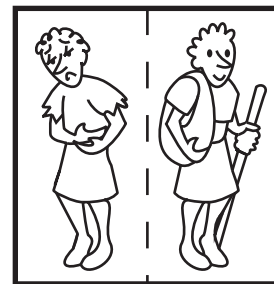
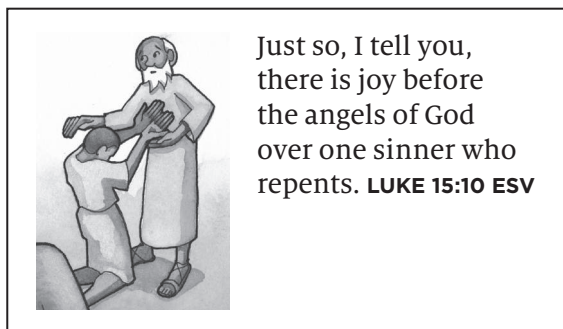
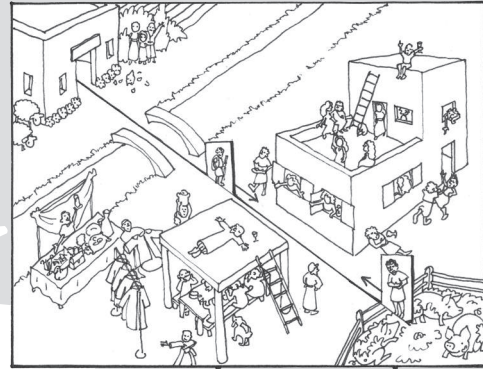

prodigal son template

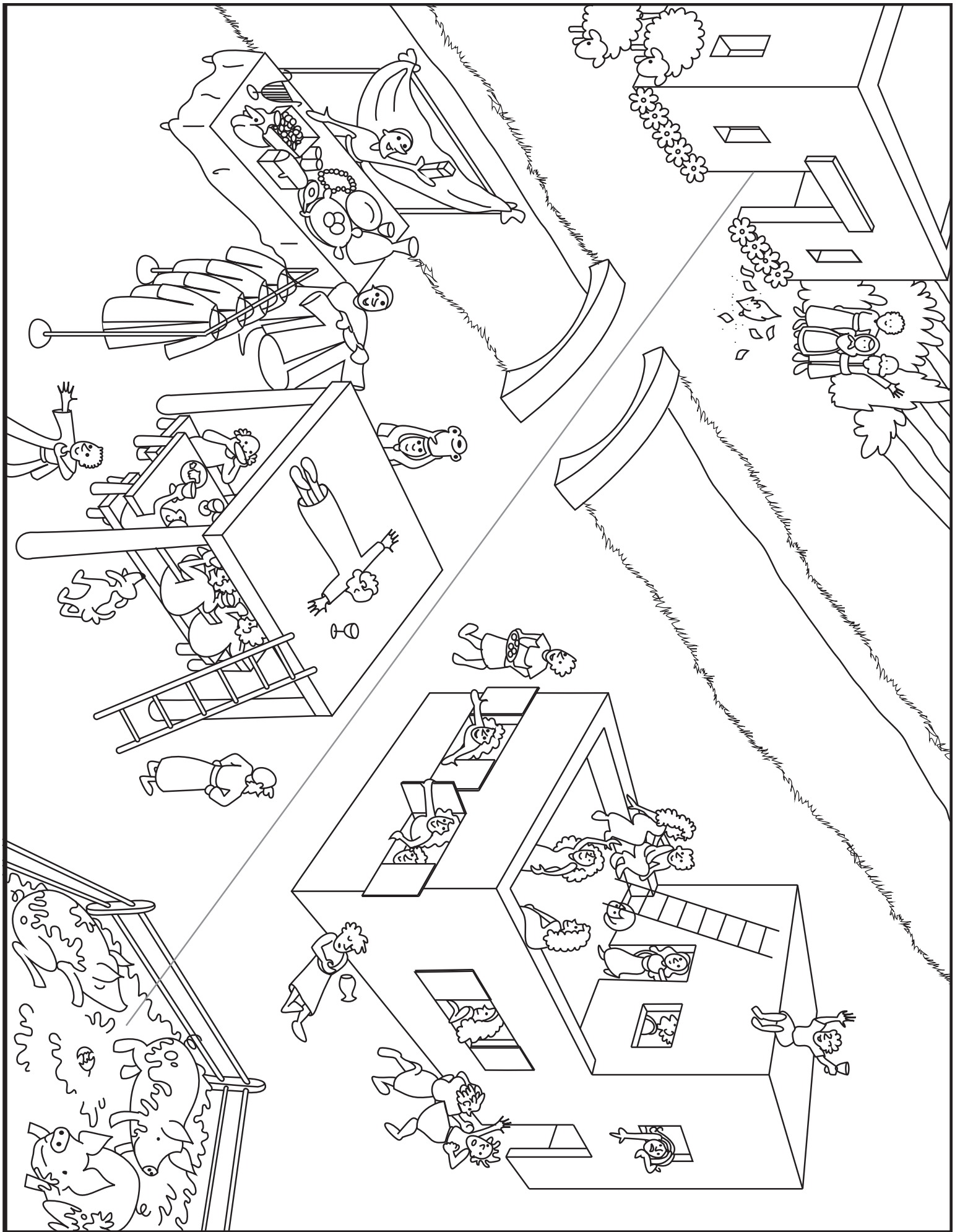



## JESUS HEALS TEN MEN WITH LEPROSY

*Luke 17:11-19*

I will give thanks to you, O LORD, among the peoples. (Ps. 57:9)

### SUPPLIES:

(to make one craft)

- template of Jesus and the lepers (the full page) (see page 197)
- 1 sheet of white copy paper
- crayons or markers
- optional: glue
- optional: 1 additional sheet of copy paper

### INSTRUCTIONS:

**PREP STEP:** Copy the full-page template of Jesus and the lepers onto white paper. *Optional for Step 3:* Copy the illustrated verse.

1. Color Jesus and the men with leprosy. Fold carefully both directions on each of the three vertical dotted lines, creasing as you go. You now have four panels, the first of which is twice as wide as the other three.
2. Arrange the creases so that the second and third panels are back-to-back, and paste them together if you wish. Lay the first and fourth panels, which now share an edge, flat on the table. When you fold the back-to-back panel to the right, you see the ten healed lepers removing their bandages as they run to show themselves to the priests. When you fold the panel to the left, you see the grateful leper who has returned to thank and worship Jesus.

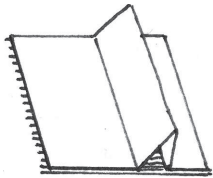

Step 2

3. *Optional:* Cut out the illustrated verse and glue it to the craft.

**MAKE IT SIMPLE:** Crease the dotted lines ahead of time, but do not paste the panels together until they have been colored.

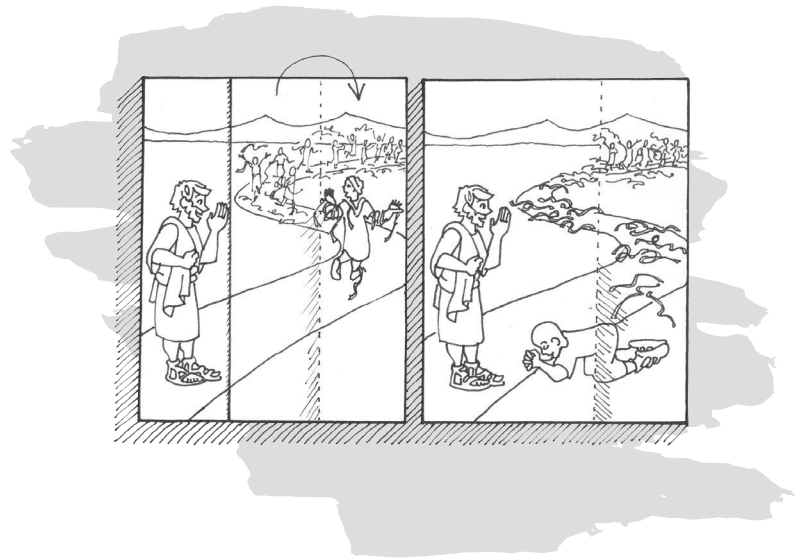

I will give thanks to you, O LORD, among the peoples.

**PSALM 57:9 ESV**

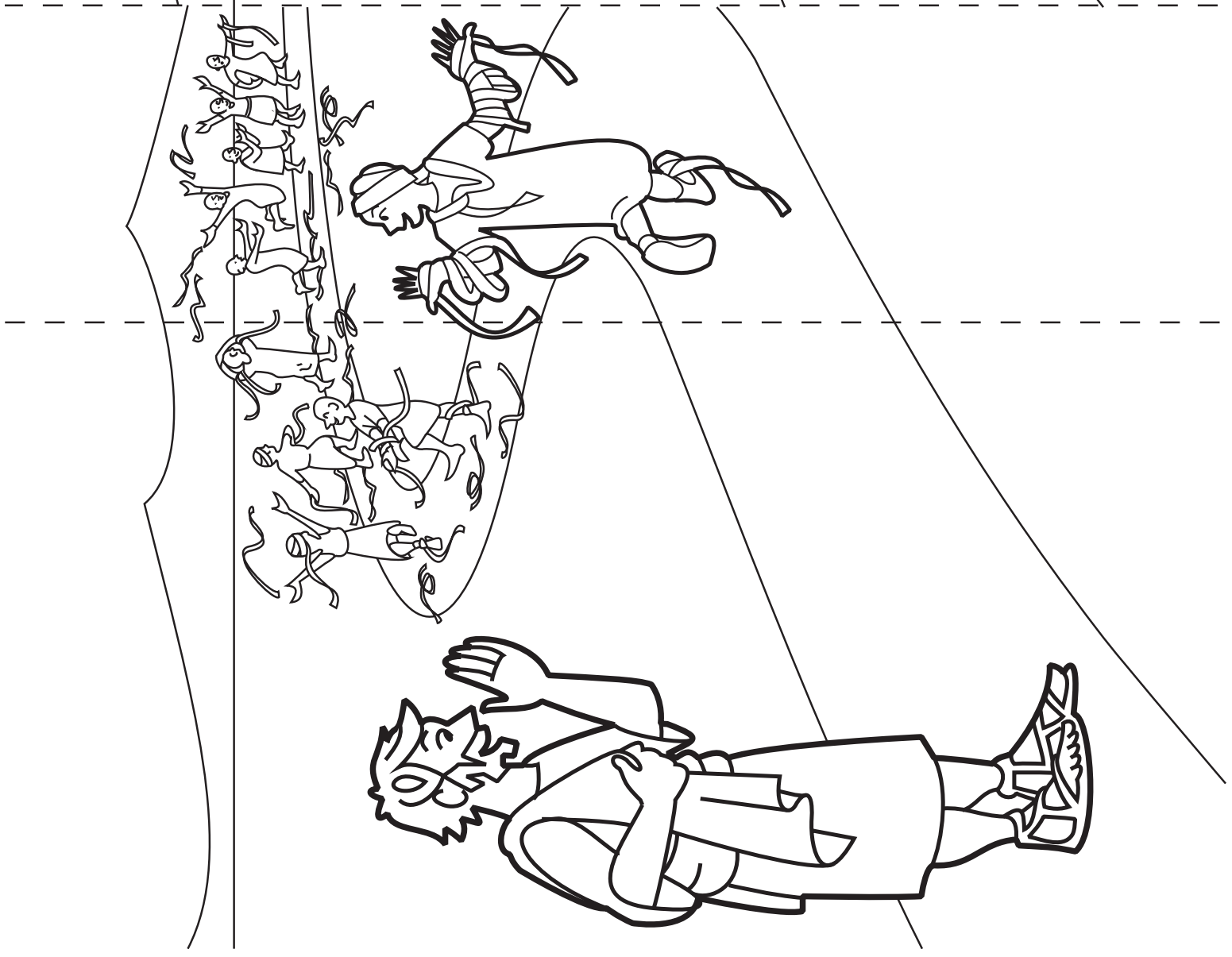

## JESUS VISITS ZACCHAEUS

*Luke 19:1-10*

For the Son of Man came to seek and to save the lost.  
 (Luke 19:10)

### SUPPLIES:

(to make one craft)

- 3 sheets of white cardstock
- templates of Zacchaeus, Jesus, and two sycamore trees  
 (see pages 199–201)
- crayons or markers
- scissors
- glue

### INSTRUCTIONS:

**PREP STEP:** Copy the Zacchaeus and Jesus templates onto white cardstock. Make double-sided copies of the sycamore trees on cardstock, keeping the upper slit on both sides of one tree and the lower slit on both sides of the other tree. (The tree will not stand up if it is made from regular copy paper, so if you do not have cardstock, glue carefully aligned copies of the trees to both sides of a manila folder or to the walls of an empty cereal box.)

1. Color the trees and cut them out along the “dome” lines around them. You should now have two double-sided dome shapes. Cut the upper slit out of one and the lower slit out of the other along the printed lines.
2. Fit the upper slit into the lower slit and stand the connected tree-domes so that they are perpendicular to each other.
3. Color Zacchaeus and Jesus and cut them out. Paste Zacchaeus into the sycamore tree.
4. Fold the Jesus figure along the dotted line so that he is double-sided. Temporarily unfold the figure and cut the base beneath his feet along the crease on the center dividing line, stopping when you reach the dotted line. Refold and glue the figure shut, but do not put any glue on the base area below the feet. Fold the base flaps up 90 degrees at the bottom of the feet so that the Jesus figure can stand freely.
5. *Optional:* Cut out the illustrated verse and paste it to the tree.

**MAKE IT SIMPLE:** Cut everything out before class and at least crease, if not glue, the Jesus figures.

**MAKE IT AMAZING:** Before gluing Zacchaeus in the tree, cover the leafy areas of the tree with glue and sprinkle on leaf-shaped confetti or tiny pieces of various shades of green paper. Cut 8 x 1-inch strips of green paper and cut grass fringe into one long side of each. Glue them over the grass drawn beneath each tree.

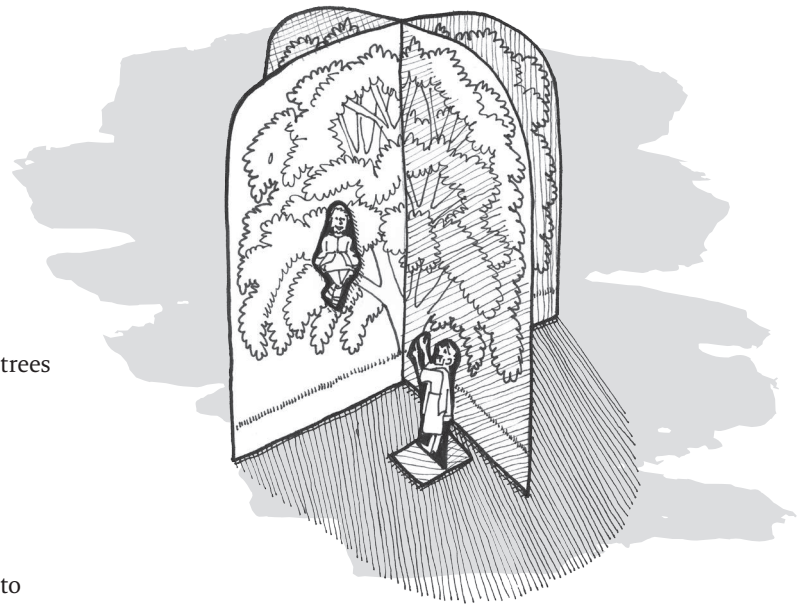

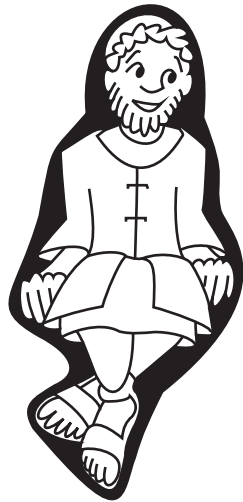

Zacchaeus template



For the Son of Man came to seek and to save the lost.

**LUKE 19:10 ESV**



Jesus template

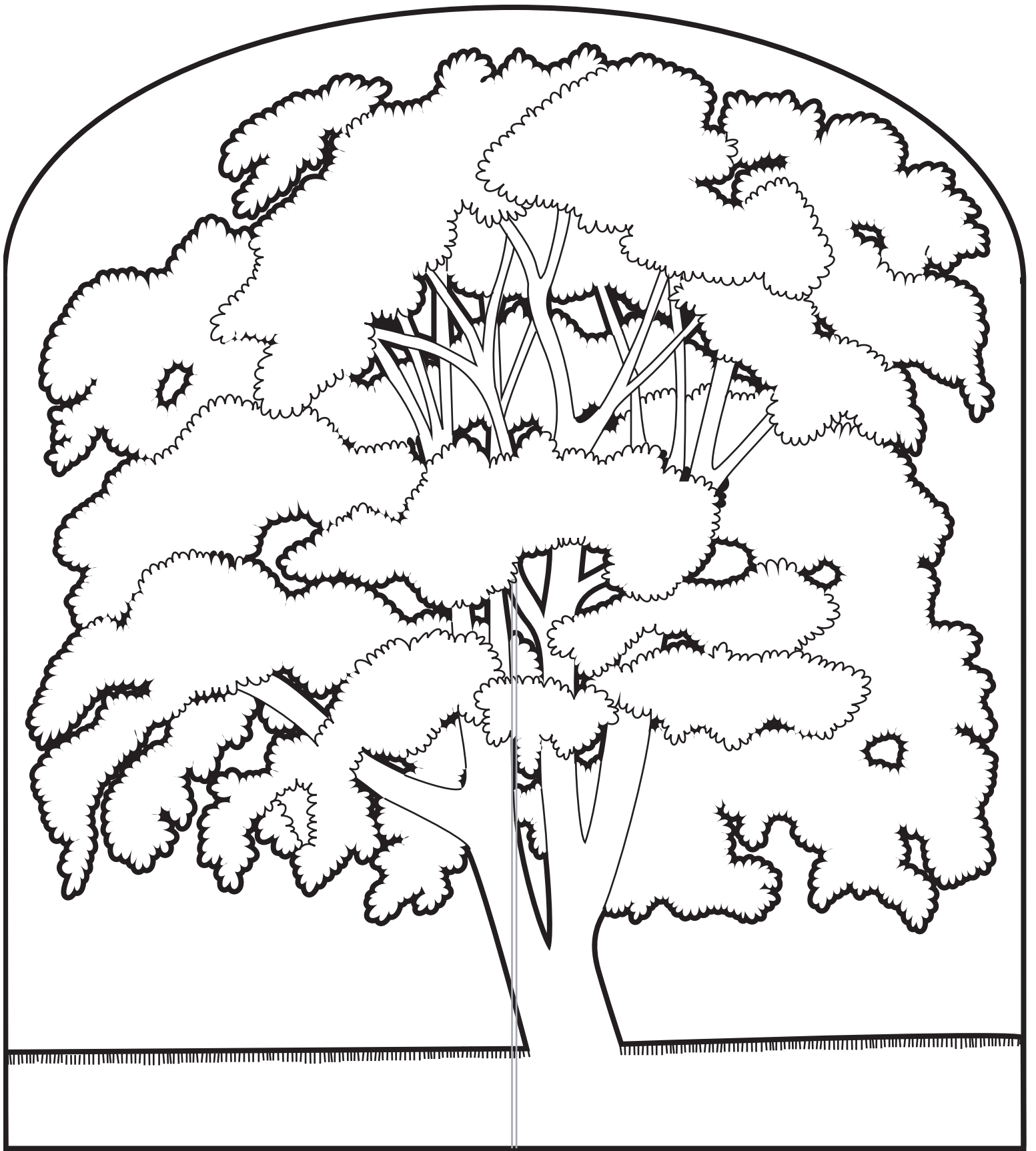

sycamore tree template



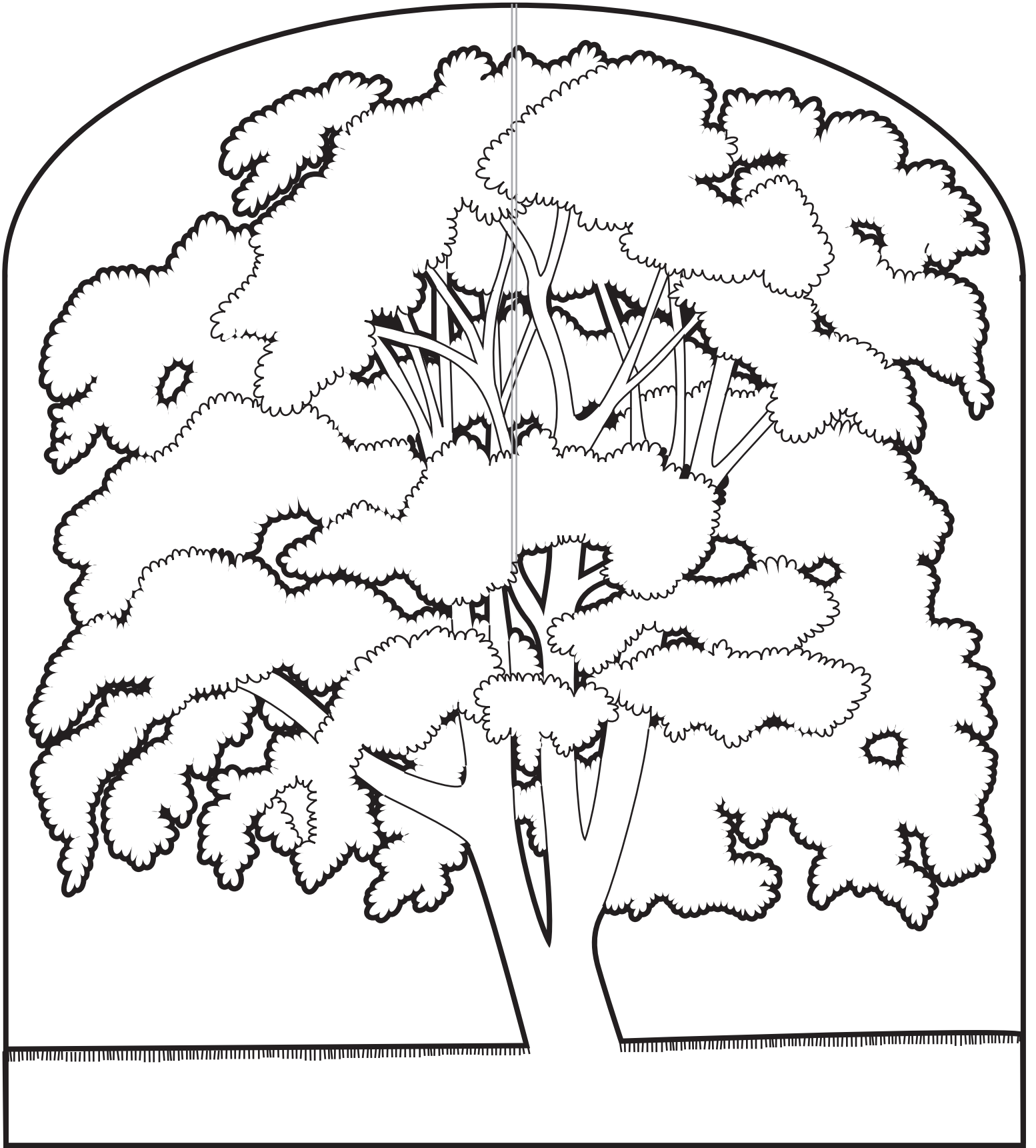

sycamore tree template

## JESUS IS WORSHIPED AS HE ENTERS JERUSALEM

*Matthew 21:1-11; Mark 11:1-10; John 12:12-19*

Hosanna to the Son of David! Blessed is he who comes in the name of the Lord! (Matt. 21:9)

### SUPPLIES:

(to make one craft)

- 2 sheets of white cardstock (the full page)
- templates of the crowd and road (the full page), Jesus on a donkey, cloaks, shawl, and palm branches (see pages 203-4)
- crayons or markers
- scissors
- scraps of fabric, felt, and/or colored paper
- optional*: 1 sheet of green paper
- optional*: plastic or silk leaves from faux plants
- glue

### INSTRUCTIONS:

**PREP STEP:** Copy the full-page crowd-and-road template and the Jesus-on-a-donkey template onto white cardstock. *Optional for Step 3:* Copy the cloaks and shawl templates onto colored paper. *Optional for Step 4:* Copy the palm leaves templates onto green paper.

1. Color the crowd-and-road picture. Fold it 90 degrees on the dotted line so that the road lays flat on the table and the crowd stands up straight.
2. Color the picture of Jesus on a donkey (excluding the “paste here” area) and cut him out along the lines of the oval. Fold the bottom section back 90 degrees to form a base so that he can stand up.
3. Cut little blankets, scarves, and t-shirt-shaped cloaks from felt or other fabric. *Alternately*, decorate the cloak images copied onto colored paper and cut them out.
4. Cut fringe into the silk leaves from a faux plant so that they resemble palm branches or cut the palm branches from green paper (with or without the templates provided).

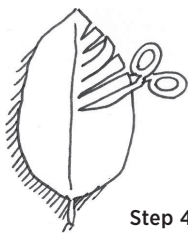

Step 4

5. Arrange the cloaks and palm leaves on the road and glue them down. Choose a place on the cloaks and branches for Jesus and his donkey to stand and glue the base down.
6. *Optional:* Cut out the illustrated verse and glue it to your craft.

**MAKE IT SIMPLE:** Copy and crease each background ahead of time, and cut out and crease the Jesus piece. Cut out most or all of the cloaks and leaves, but let the students fringe them if they are able. If your time is limited, just draw the cloaks and palm branches directly onto the road.

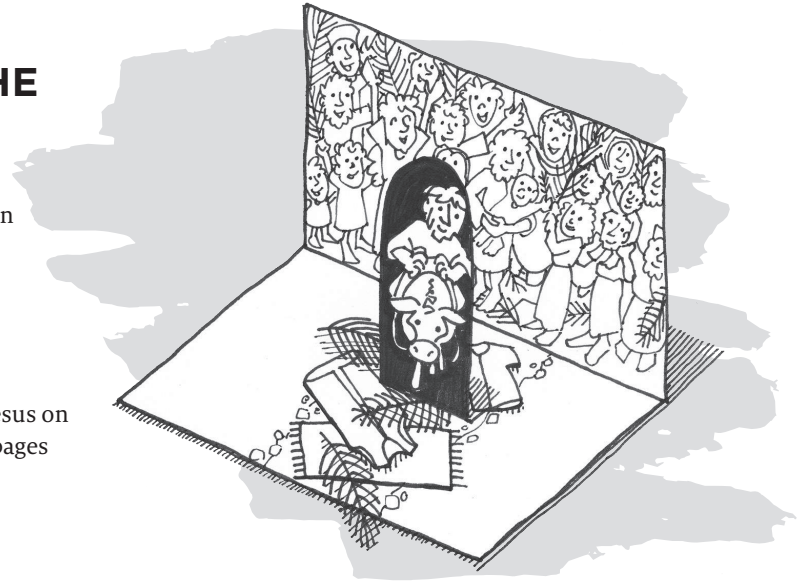

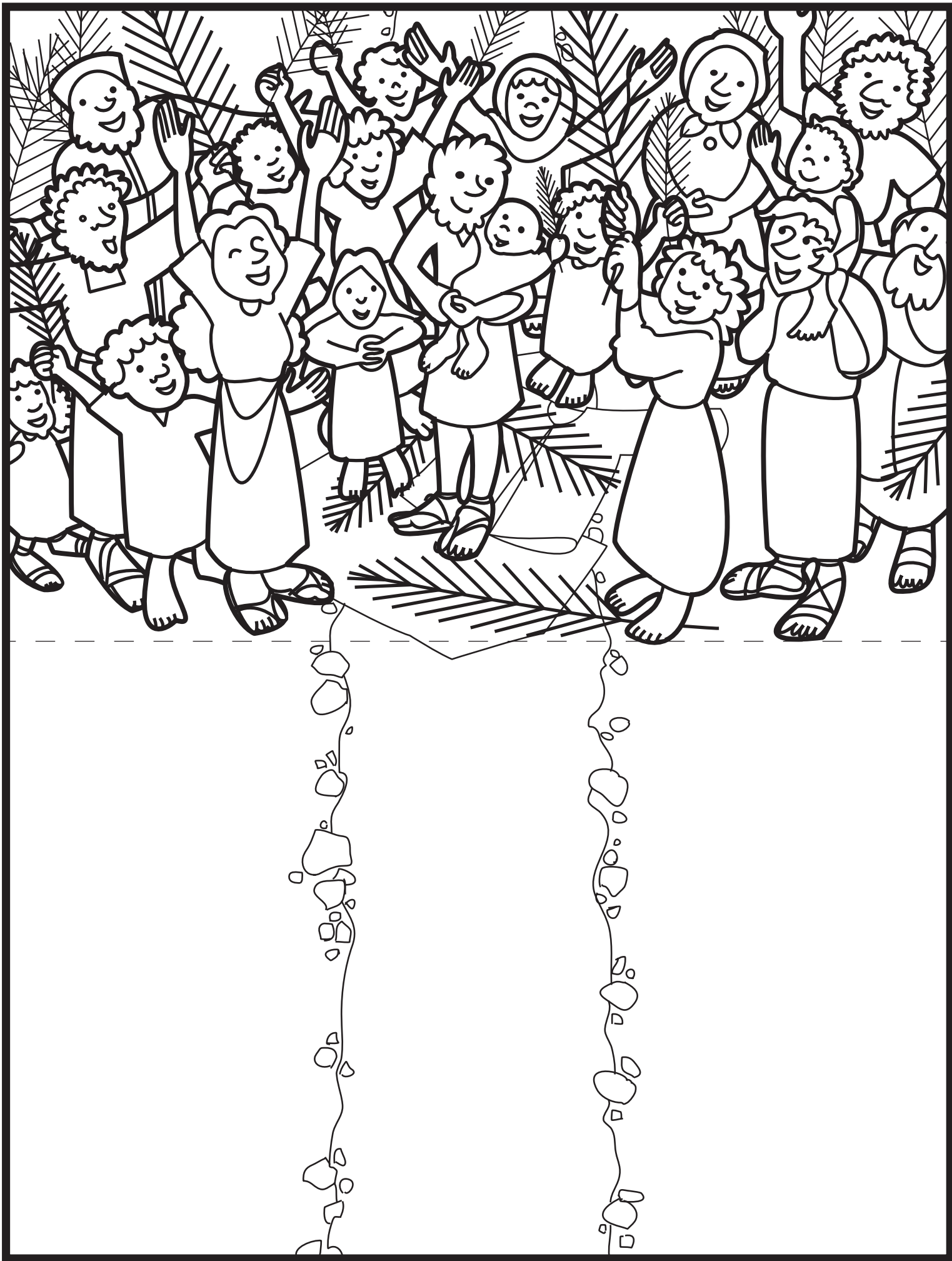

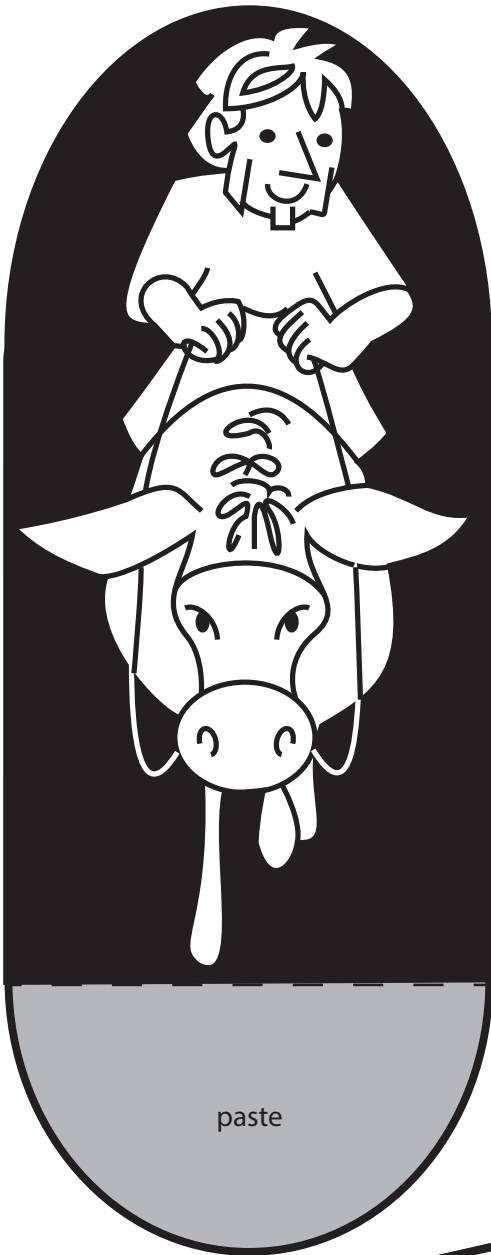

Jesus on a donkey template

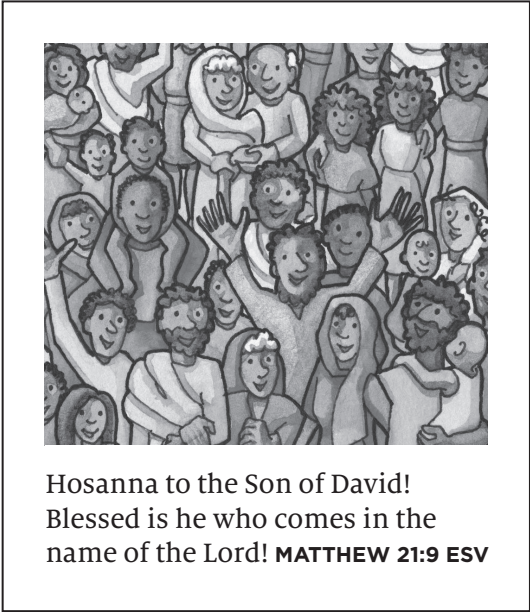

Hosanna to the Son of David!  
Blessed is he who comes in the  
name of the Lord! **MATTHEW 21:9 ESV**

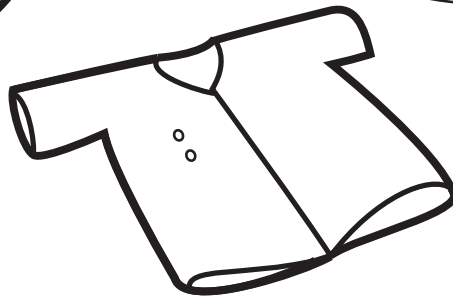
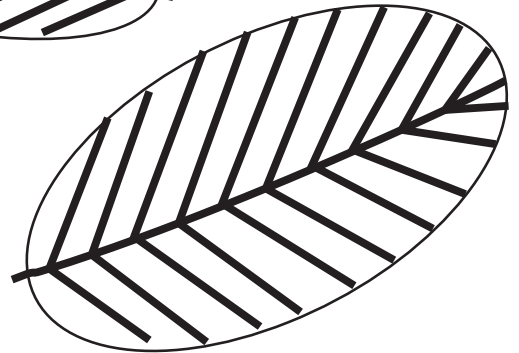
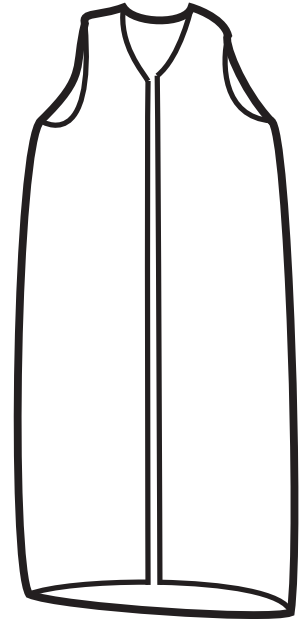

cloaks, shawl, and palm  
branches templates

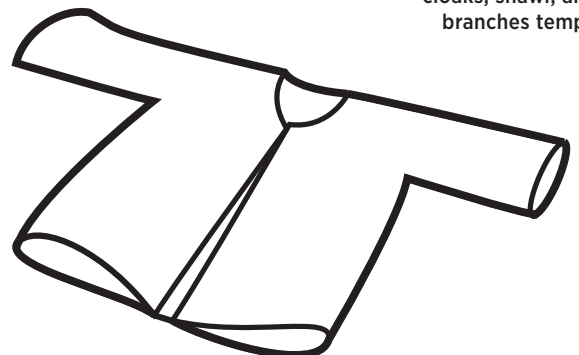

## JESUS CLEARS THE TEMPLE

*Matthew 21:12–17; Mark 11:15–19; John 2:13–22*

Jesus answered them, “Destroy this temple, and in three days I will raise it up.” (John 2:19)

### SUPPLIES:

(to make one craft)

- 2 sheets of white cardstock
- templates of Jesus and the money changers (the full page) and the additional money changers (see pages 206–7)
- crayons or markers
- 1 sheet of skin-colored paper
- scissors
- glue

### INSTRUCTIONS:

**PREP STEP:** Copy the full-page template with Jesus onto white cardstock, as well as the template of the additional money changers.

1. Color the full-page picture of Jesus, excluding the gray area. Trace your left hand onto another piece of paper, color it, and cut it out. Put glue behind the palm area only and glue it next to Jesus, with the thumb on the left, as though Jesus is raising his hand to say “Stop!”
2. Color the additional money changers and cut them out as one large rectangle. Carefully fold the bottom third back along the dotted line and crease well. Glue the folded section closed (it will be a double-sided flap). Now fold the top third of the original rectangle down so that it perfectly covers the glued back-to-back thirds beneath it. Put glue on the rectangle that is now facing you (the back of the top third of the original rectangle), flip the whole thing over, and press it down on the gray rectangle on your big picture with Jesus in the foreground. As you press it down, align the top and bottom halves of the money changers and sheep.

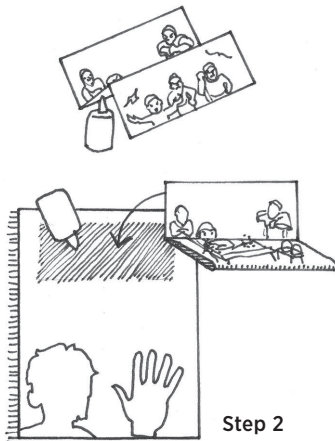

3. Now you can see the greedy money changers when the flap is down and the tables overturned by Jesus when the flap is lifted. Glue the tip of Jesus’s thumb onto the tip of his pinky finger, leaving him with three fingers raised to indicate the number of days he will take to raise up the temple.

**MAKE IT SIMPLE:** Trace and label students’ hands as they enter the classroom and have an assistant cut them out during story time. *Alternately*, just cut out identical 4-inch hands ahead of time. Construct and paste the flaps in place before class, since they can be colored after assembly.

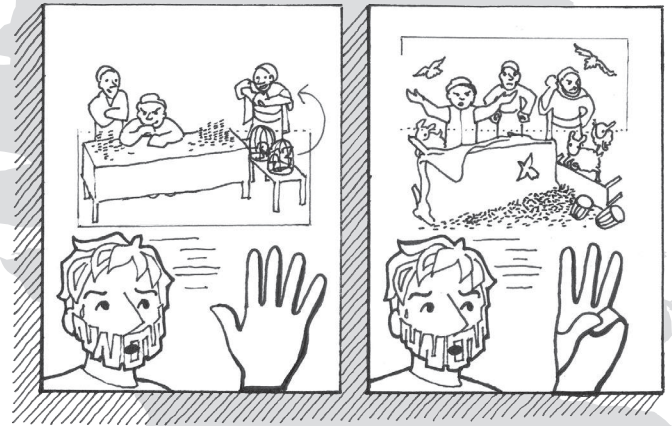





Jesus answered them,

“Destroy this temple, and in  
three days I will raise it up.”

**JOHN 2:19 ESV**



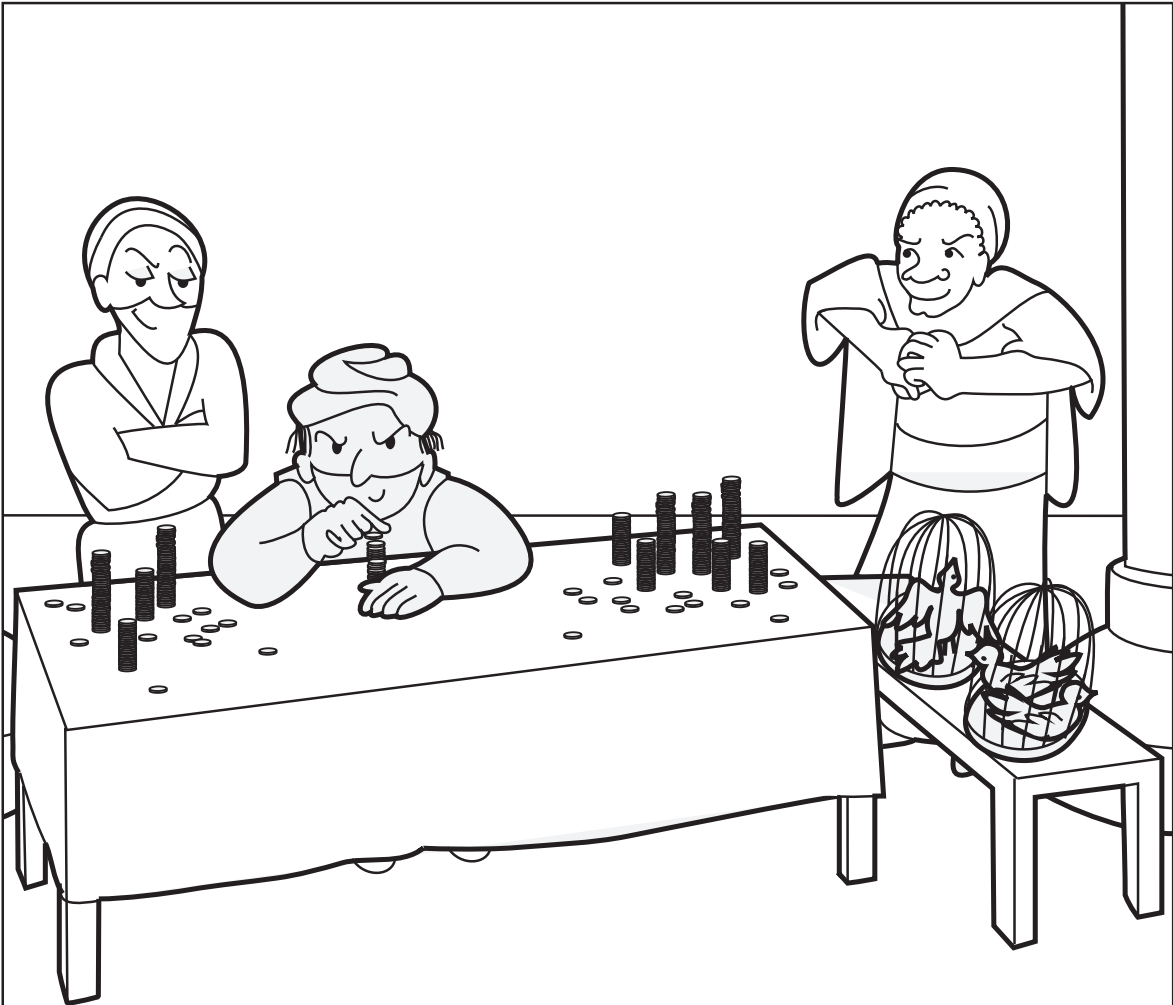

additional money changers template

## JESUS ESTABLISHES THE LORD'S SUPPER

*Mark 14:22-25; Luke 22:14-23*

This is my body, which is given for you. Do this in remembrance of me. (Luke 22:19)

### SUPPLIES:

(to make one craft)

- 2 sheets of white cardstock or copy paper
- templates of plate and cup (see pages 209-10)
- plain paper or foam cup
- crayons or markers
- scissors
- glue
- 1 sheet of colored paper
- tape
- 1 stale pita or tortilla or template of bread from Craft 75 "Jesus Feeds a Large Crowd"
- optional*: 1 sheet of tan cardstock (for the bread)
- red-colored tissue paper
- crayons or markers

### INSTRUCTIONS:

**PREP STEP:** Copy the templates onto white cardstock or paper. *Optional for Step 3:* Copy bread template from Craft 75 "Jesus Feeds a Large Crowd" onto white or tan cardstock.

1. Color the plate, cut it out, and glue it onto a colored-paper "placemat."
2. Color the cup and cut it out as a big rectangle. Fold the bottom inch back along the dotted line. Cut each of the thirteen vertical lines from the edge of the paper to the fold. Roll the paper into a cylinder, beginning with the unprinted end, and ending so that the picture of the altar with the ram just meets but doesn't cover the picture of Jesus shedding blood (on the opposite end). Secure the seam with tape. Turn the cup upside down and arrange the tabs to form the bottom of the cup so that it is as round as possible. Secure them with a single strip of tape. Glue the bottom of the cup piece onto the placemat next to the plate. (*Alternately*, you could also cut out the pictures that go on the cup and glue them to a plain paper or foam cup.)

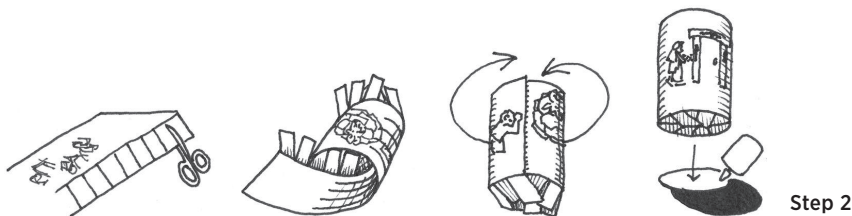

Step 2

3. Cut a 6-inch circle from a stale pita or tortilla or color and cut out the bread image. Glue the "bread" onto the plate. Make a ball of red tissue-paper "wine" that will fit inside your cup, then slip it in with a smooth side on top, and glue it in place.
4. *Optional*: Cut out and glue the illustrated verse onto your craft.

**MAKE IT SIMPLE:** Have everything cut out ahead of time. Younger students will need help assembling their cups, so have them color cups first, then tape them while students color their plates. If need be, eliminate the colored placemat and do not cut out the plate.

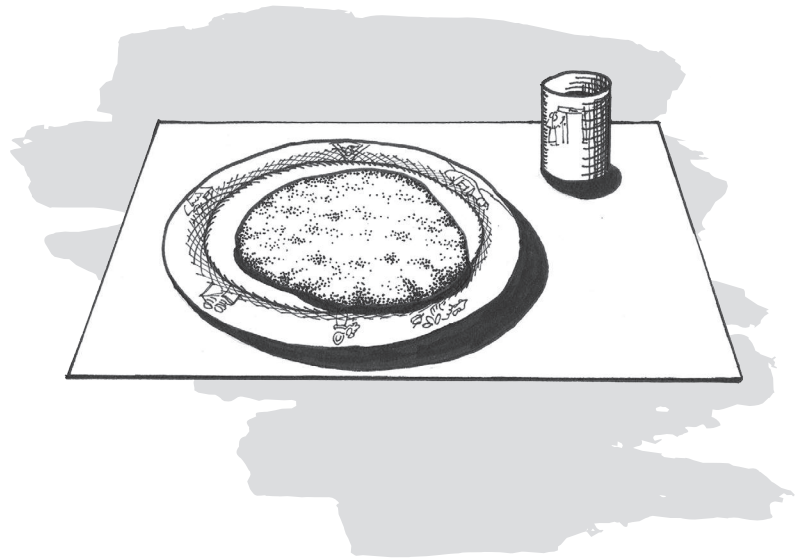



This is my body, which is given for you. Do this in remembrance of me.

**LUKE 22:19 ESV**

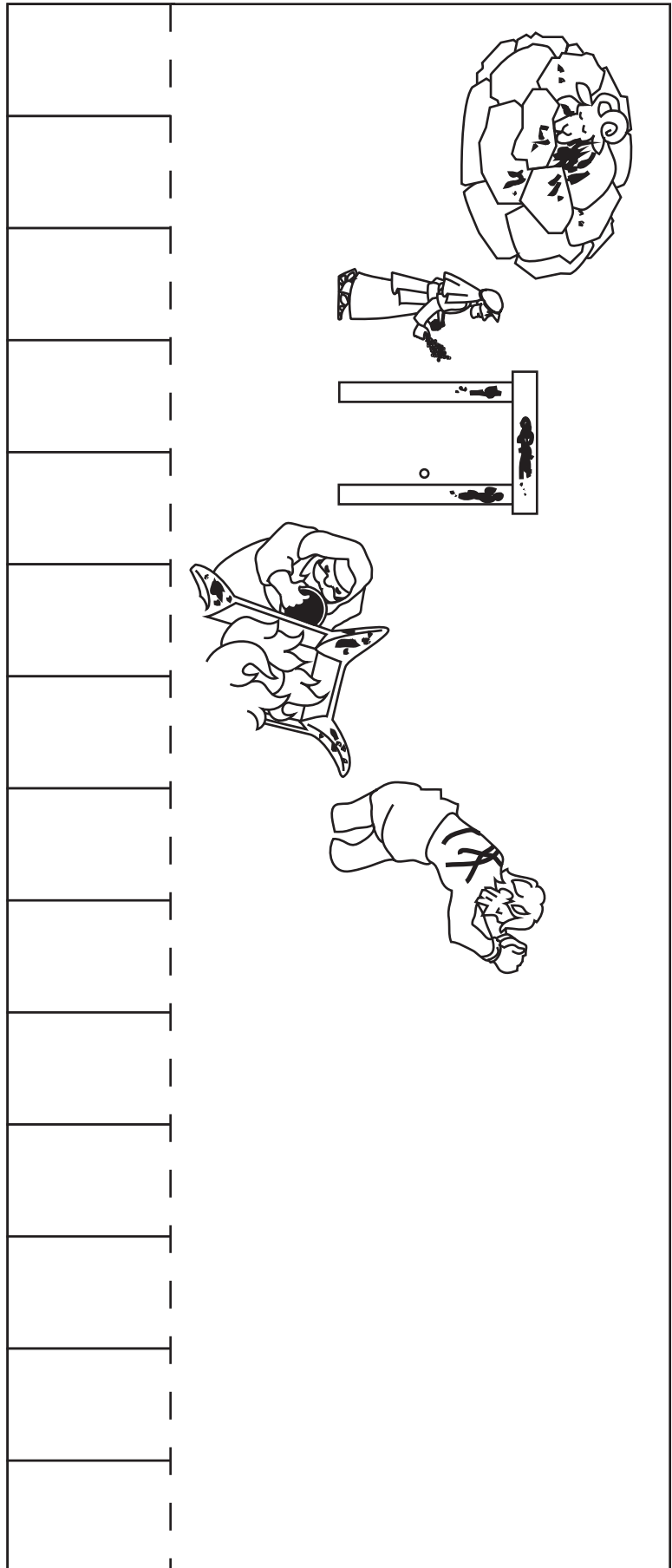

cup template

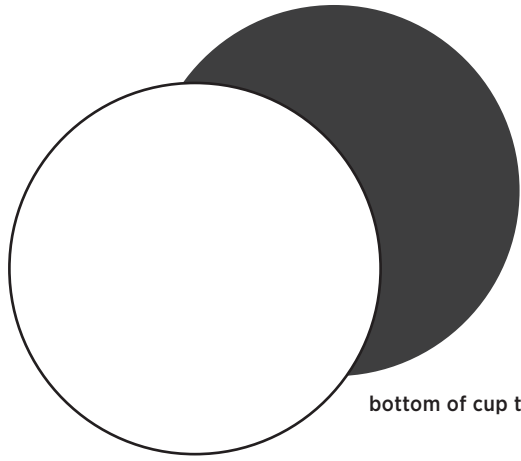

bottom of cup template

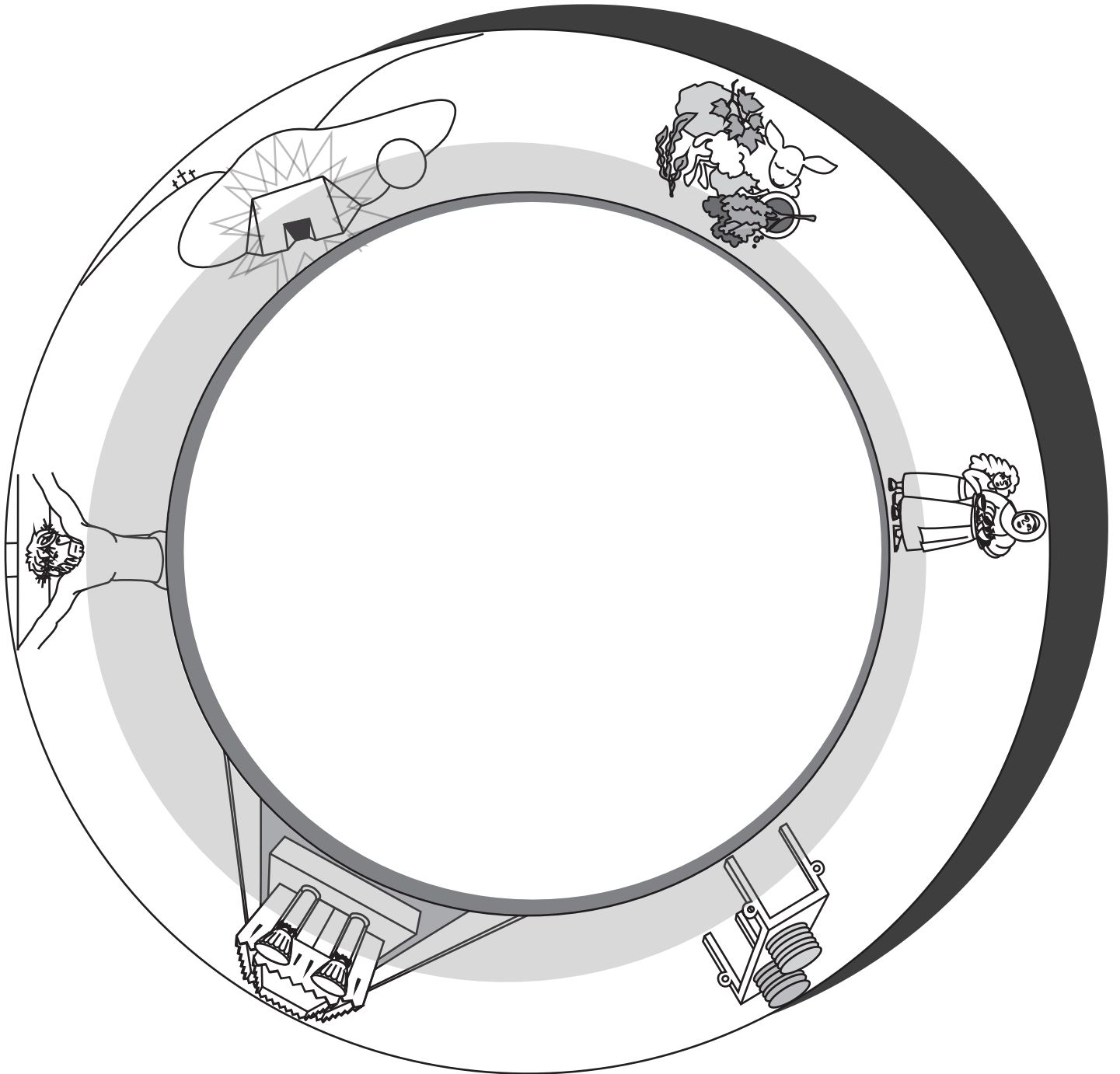

plate template



## PETER DENIES JESUS

Mark 14:66-72; John 18:15-18, 25-27

If anyone would come after me, let him deny himself and take up his cross daily and follow me. (Luke 9:23)

### SUPPLIES:

(to make one craft)

- 2 sheets of white copy paper
- templates of rooster parts (see pages 212-13)
- 1 sheet of red-colored paper
- crayons or markers
- two 9-inch paper plates
- scissors and *optional* craft knife such as X-Acto™
- hot-glue gun or stapler
- black marker or two large googly eyes

### INSTRUCTIONS:

**PREP STEP:** Copy the templates of rooster parts onto white paper to use as a pattern.

1. Using the template as a pattern, cut the beak and comb shape from red paper. Overlap at least four layers of red paper and trace your hand with fingers spread. Cut out all the hand shapes at once.
2. Fold one paper plate in half with the bottom of the plate out. Use the copy of the rooster's head and wings to cut the folded plate into the shapes marked, then crease them on the dotted lines. Fold the other plate in half with the top of the plate out and crease. Slit the crease from the left edge inward 2 ½ inches. Lay a head-and-wing piece, "facing" left and with the wing folded back on its crease, on the "body" plate and mark where the wing crease falls. Use a craft knife (with adult assistance) to slit through both layers of the body plate where you marked the wing crease. Now tuck both head-and-wing pieces into the body plate with the head rising from the top slit and the wings poking out through the side slits (one on each side). Arrange the red beak-and-comb piece between the head pieces, then hot glue or staple the head closed with the beak piece inside.
3. Take the piece marked "legs and feet" that you cut from the first plate and slit the crease between the feet so they can separate. Fold them 90 degrees out to the sides. Slip the top of the legs up inside the body plate with the straight edge on the left, then hot glue or staple in place. Slip your hand shapes (wrist in, thumbs down) into the back end of the rooster to form its tail. Slit the plate crease a bit if you want the tail feathers to stick up some. Hot glue or staple the body plate closed with the neck, legs, and tail feathers between the plate halves.
4. Glue a large googly eye to both sides of the head or draw eyes with a black marker.
5. *Optional:* Cut out and paste the illustrated verse to the rooster.

**MAKE IT SIMPLE:** Trace and label students' hands as they enter the classroom, then have an assistant cut them out during story time. Cut, slit, and crease everything ahead of time, and glue or staple the heads together with the beaks and combs, but let students thread the wings through the slits. Fasten the legs to one side of the body plate so they are in place, making sure the plate can still open to thread the wings and arrange the tails.

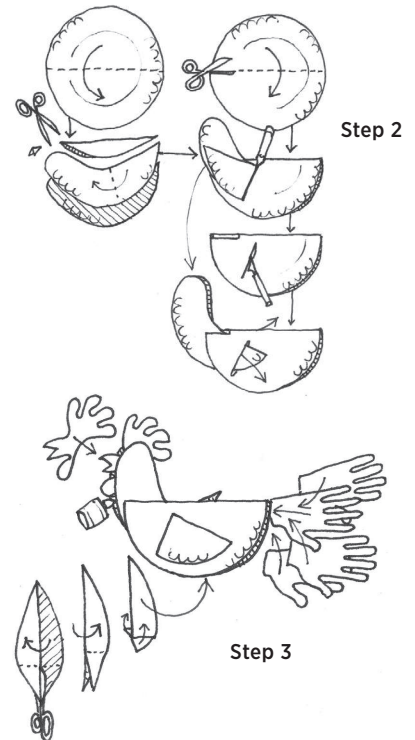
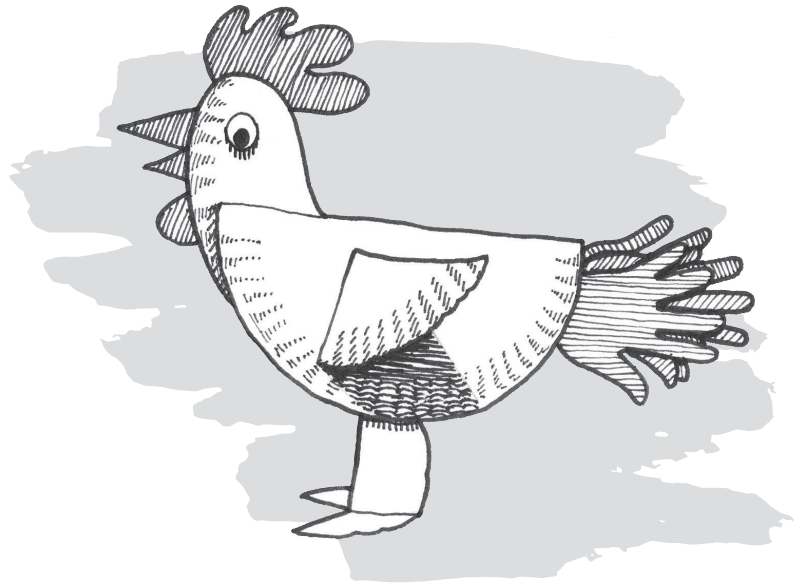

Step 2

Step 3

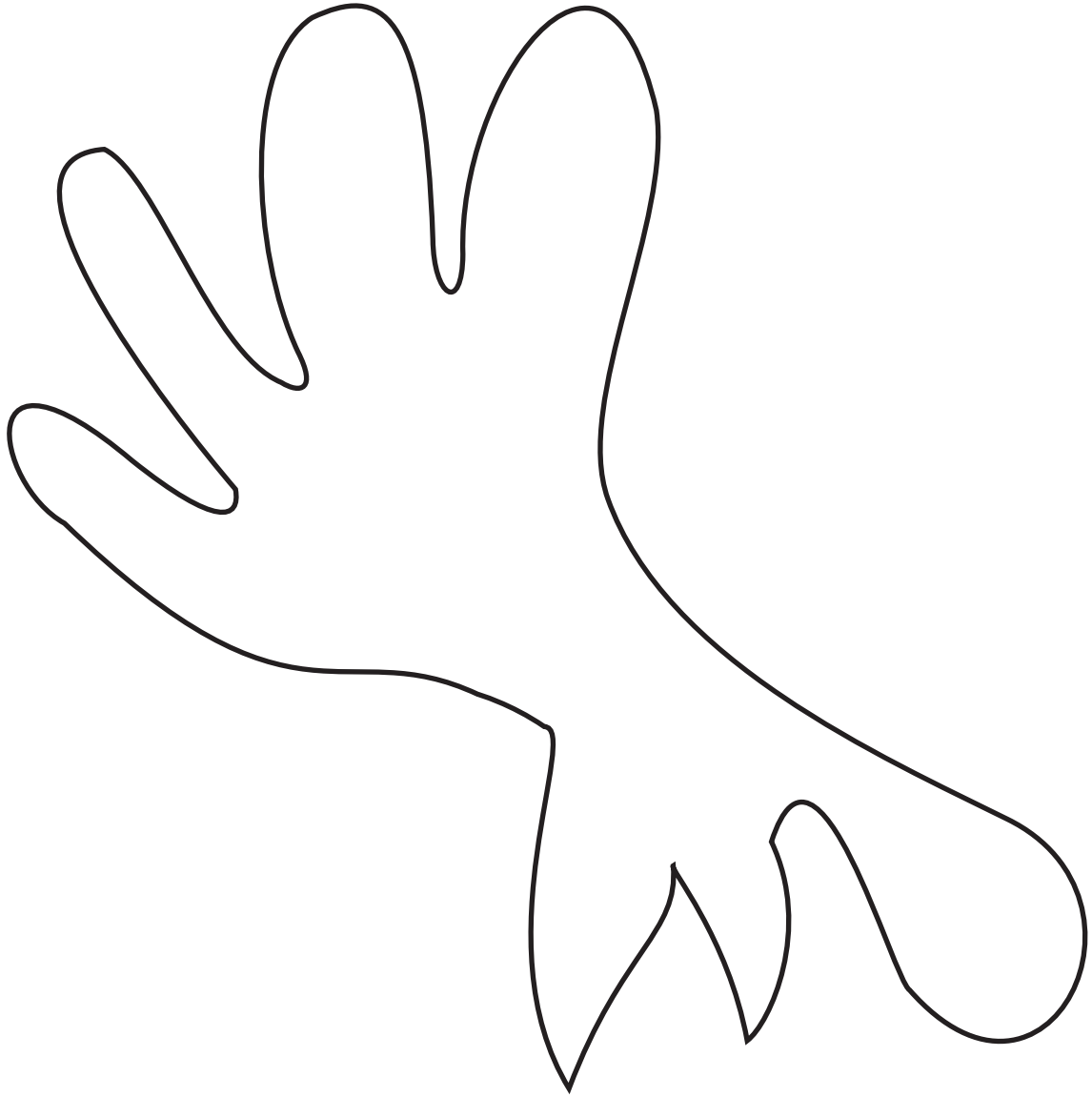

beak and comb template



If anyone would come after me, let him deny himself and take up his cross daily and follow me.

**LUKE 9:23 ESV**



rooster parts template

## JESUS IS CRUCIFIED

*Matthew 27:22-66; Mark 15:20-47;  
 Luke 23:25-56; John 19:12-42*

For Christ also suffered once for sins, the righteous for the unrighteous, that he might bring us to God. (1 Pet. 3:18)

### SUPPLIES:

(to make one craft)

- 1 sheet of black, purple, or dark blue colored paper
- template of framed cross (see pages 216-17)
- 1 sheet of white copy paper
- tape
- scissors
- clear self-adhesive shelf-lining paper such as Con-Tact™ or Duck™
- at least 4 different colors of tissue paper

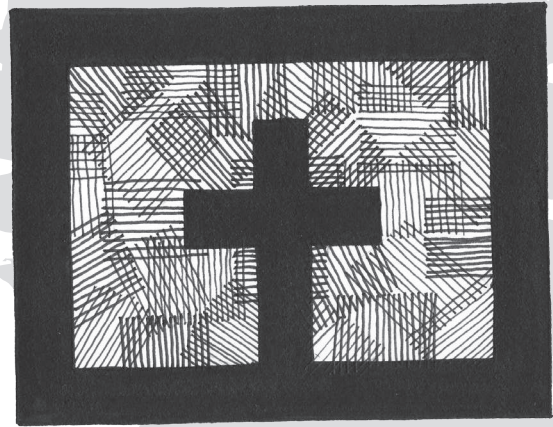

### INSTRUCTIONS:

*You'll need to fold your colored paper in half (crosswise) to determine which template fits the dimensions of your paper before you can start this craft.*

**PREP STEP:** Copy the proper-sized template of the framed cross.

1. Fold your colored paper in half crosswise. Then align the cross frame over your colored paper so that the half-cross edge of the frame is directly over the crease in your colored paper. Temporarily tape the template in place if necessary and cut out the area so labeled on the template, cutting through the template and both layers of colored paper as you go. Open the colored paper to find a rectangular frame with a cross in the center.

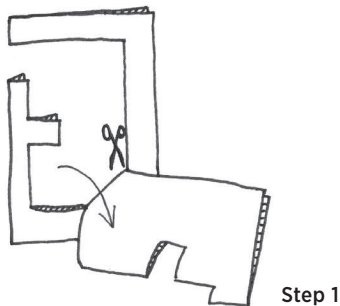

2. Carefully pull back the liner from a piece of clear self-adhesive paper, and place your framed cross flat on the sticky side of the paper, trying not to leave fingerprints on the adhesive. Lay the liner back down so that your construction paper is sandwiched between the adhesive paper and its liner. Turn it clear-side up so that you can see your framed cross and cut around its outer edges.

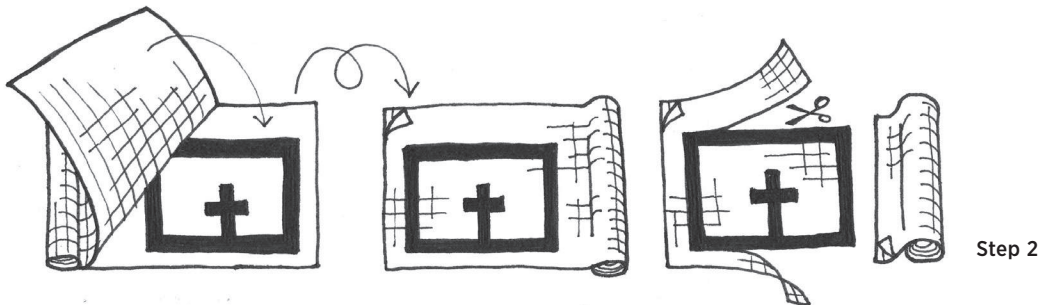

3. Place several layers of colored tissue paper atop each other, and cut out squares through many layers at a time. If you have a lot of time to spend on this craft, cut squares as small as 1 inch. If you do not have a long time to work on this, then cut squares as large as 3 inches.
4. Lay your framed cross face-down on the table and remove its backing sheet. Completely fill the clear area around the cross with overlapping (but flat) tissue-paper squares. Feel free to turn them to various angles and overlap them to different degrees.

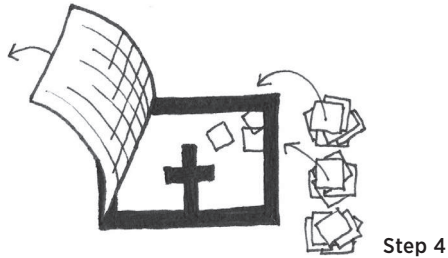

5. *Optional:* Cut out the illustrated verse and paste it to the “frame” portion of your craft.

**MAKE IT SIMPLE:** Complete the first three steps before class.

↪ This edge runs along the crease of your folded black, purple, or dark blue paper. ↪

Cut this area out.



For Christ also suffered once for sins,  
the righteous for the unrighteous, that  
he might bring us to God. **1 PETER 3:18 ESV**

framed cross template (for 9 x 12 paper)



This edge runs along the crease of your folded black, purple, or dark blue paper. ↪

Cut this area out.

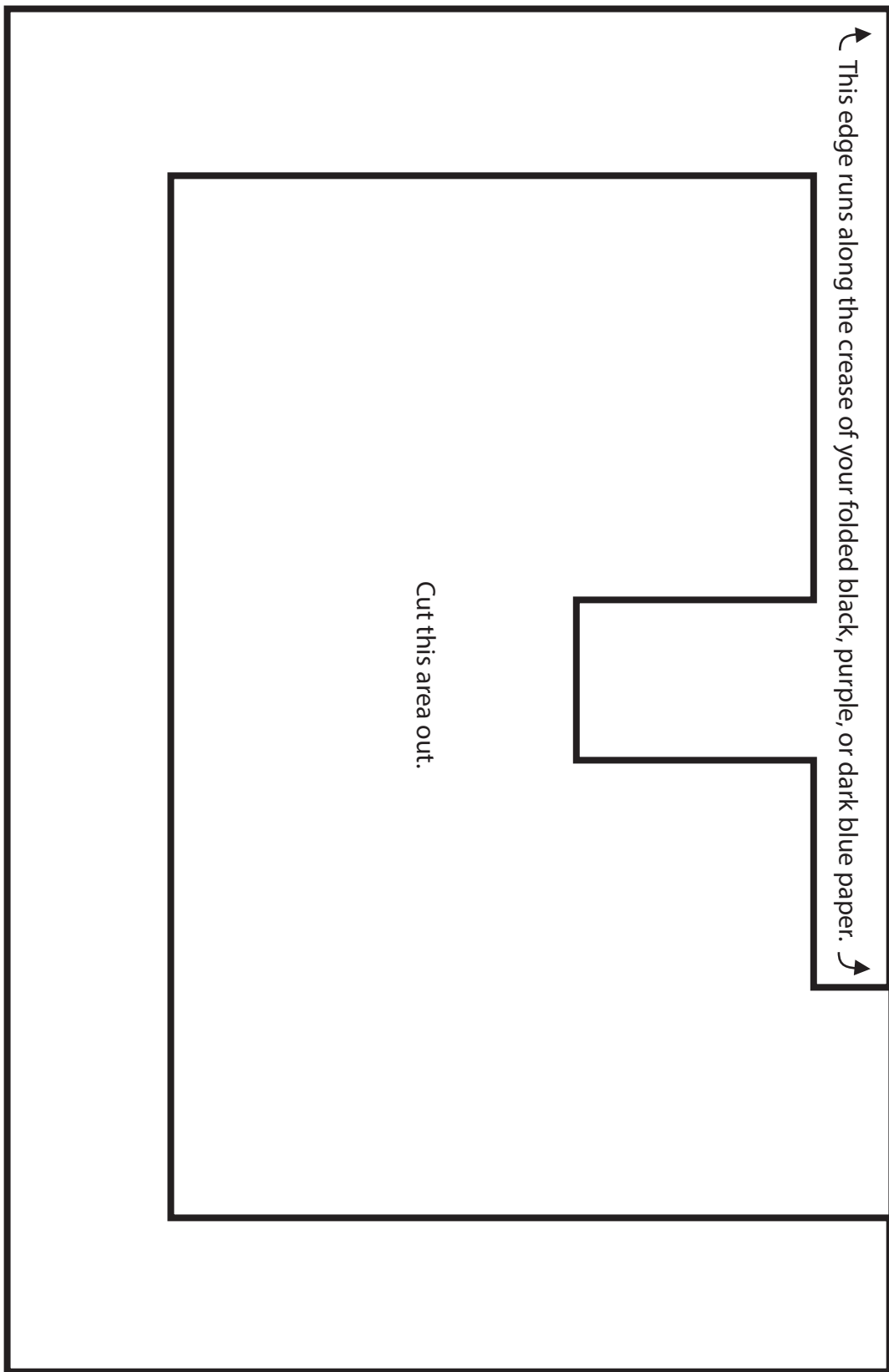

For Christ also suffered once for sins,  
the righteous for the unrighteous, that  
he might bring us to God. **1 PETER 3:18 ESV**

# JESUS IS ALIVE!

Mark 16:1-8

He is not here, for he has risen, as he said. (Matt. 28:6)

## SUPPLIES:

(to make one craft)

- 1 paper dinner plate, preferably without ribbed edges
- hot-glue gun
- scissors and *optional* craft knife such as X-Acto™
- crayons or markers
- 3-inch circle of craft foam sheet or cardstock
- 1 brass fastener
- templates of angel and three women (see below)
- 1 sheet of white copy paper
- glue

## INSTRUCTIONS:

**PREP STEP:** Copy the angel and woman templates onto white copy paper.

1. Create an empty tomb: Cut the paper plate exactly in half, then use hot glue to fasten the halves together along only the rim. Cut a 2 x 2-inch doorway with a rounded top out of one side of the tomb, off center. Color the tomb if you wish.
2. Cut a 3-inch circle out of craft foam or cardstock to be the stone that was rolled away. Use a brass fastener to attach it to the tomb where it can swivel to both cover and clear the doorway completely. You may want to use a craft knife to cut a tiny “x” where the brass fastener will pass through the plate and the foam or cardstock.
3. Color the angel and woman images and cut them out. Paste them inside the tomb where they can be at least partially seen when the foam stone is rolled aside.
4. *Optional:* Cut out the illustrated verse and paste it to the back of the tomb.

**MAKE IT SIMPLE:** Create the tombs and stones ahead of time. If you must use regular glue, let it dry overnight before you color the tomb or fasten on the stone. Cut out the figures ahead of time.

**MAKE IT AMAZING:** Paint your tomb the color of earth or stone and choose coordinating foam for your stone door. Better yet, use “Make It Stone!” textured spray paint by Krylon™.

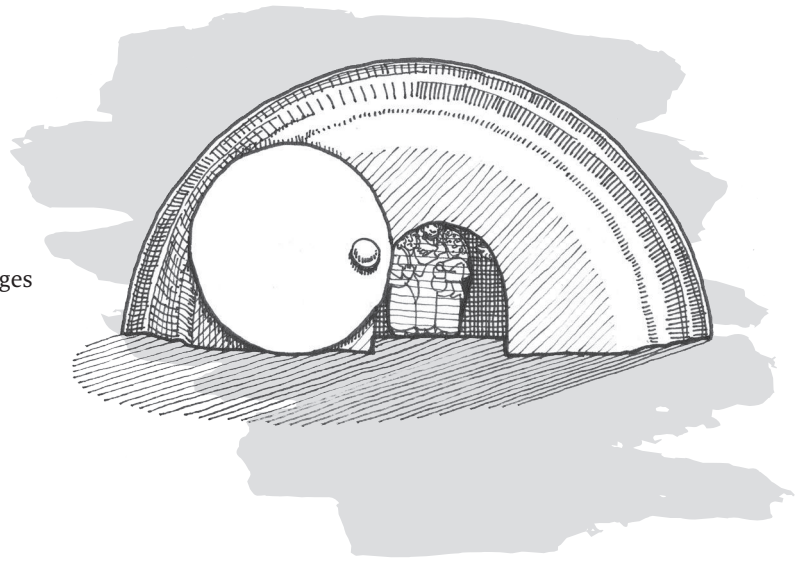

three women template



angel template

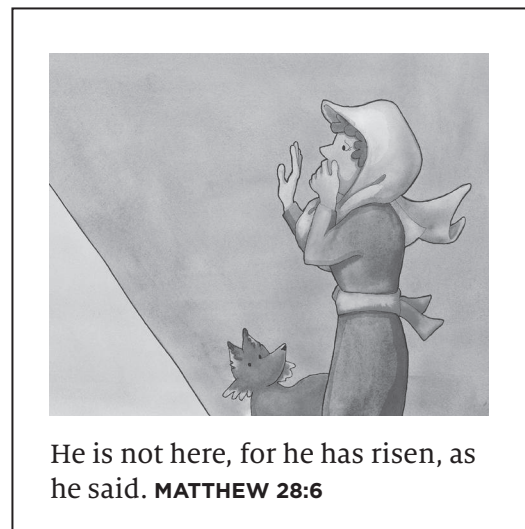

He is not here, for he has risen, as he said. **MATTHEW 28:6**

## JESUS RETURNS TO HEAVEN AND SENDS HIS SPIRIT

*Acts 1:1-11; 2:1-41*

You will receive power when the Holy Spirit has come upon you, and you will be my witnesses. (Acts 1:8)

### SUPPLIES:

(to make one craft)

- 1 sheet of white copy paper
- templates of apostles and ascending Jesus (see page 220)
- crayons or markers
- scissors
- 1 sheet of blue cardstock or paper
- glue
- 2 to 4 cotton balls
- orange and/or yellow tissue paper

### INSTRUCTIONS:

**PREP STEP:** Copy the templates of the apostles and ascending Jesus onto white copy paper.

1. Color the apostles and Jesus and cut them out. Fold the apostles picture on the dotted line so that the figures are on the outside.
2. Cut a piece of blue cardstock or paper in half crosswise. Tuck it all the way into the folded apostles picture so that its long edge lies in the crease, and glue it in place. On the “ascension” side of the picture, glue Jesus up in the “sky.” Stretch out some cotton balls to form clouds and glue them in the sky with at least one cloud beginning to hide Jesus from view.
3. Cut six squares of orange and/or yellow tissue paper, each about 2 inches wide. Pinch each square in its center and pull its corners together, away from the pinched center, and crease to form tufts or “tongues” of flame. Turn to the “Pentecost” side of the picture, dip the pinched end of each tissue tuft in glue, and then place it above the head of an apostle.
4. *Optional:* Cut out the illustrated verse and paste it to your picture.

**MAKE IT SIMPLE:** Copy and cut figures and tissue paper before class. The people on both sides of the paper should be colored and glued before either the clouds or flames go on. Lay down wax paper, parchment paper, or a plastic tablecloth over the work surface since there is glue on both sides of this picture.

**MAKE IT AMAZING:** Use white or blue glitter glue or paint to add swirls of wind to the Pentecost picture. Let it dry completely before picking it up or turning it over.



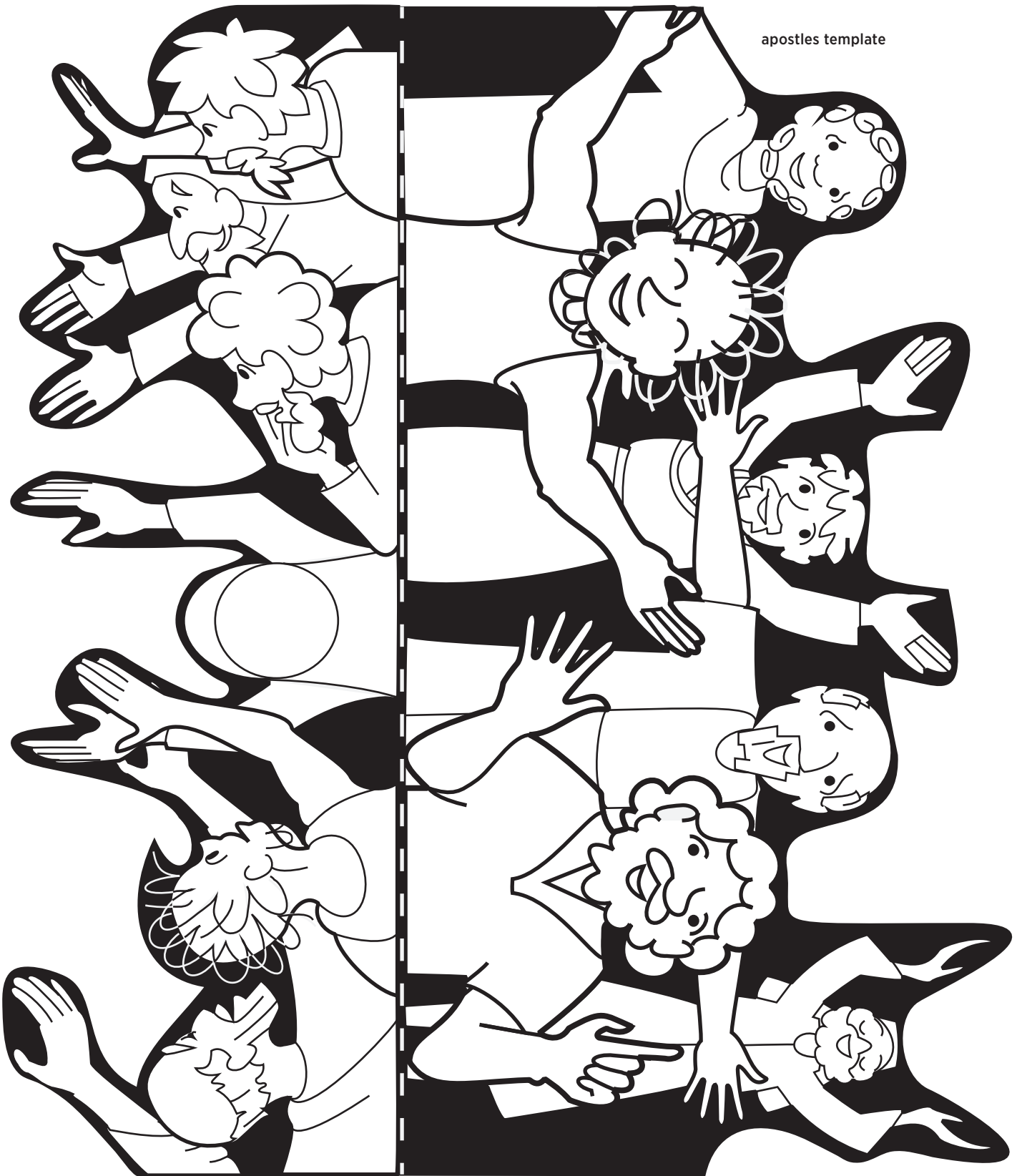

You will receive power when the Holy Spirit has come upon you, and you will be my witnesses.  
**ACTS 1:8 ESV**

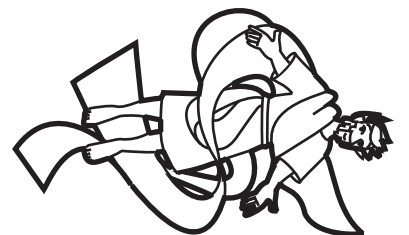

ascending Jesus template

## GOD HEALS A MAN THROUGH PETER AND JOHN

Acts 3:1-4:31

Declare his glory among the nations, his marvelous works among all the peoples! (Ps. 96:3)

### SUPPLIES:

(to make one craft)

- 2 sheets of white cardstock
- templates of the beautiful gate (the full page), Peter, and the lame man (see pages 222-23)
- crayons or markers
- scissors and *optional* craft knife such as X-Acto™
- glue

### INSTRUCTIONS:

**PREP STEP:** Copy the full-page gate template and the templates of the lame man and double-sized Peter onto white cardstock.

1. Color the pictures of the beautiful gate, Peter, and the lame man. Fold the picture of the beautiful gate on the dotted line and crease well. Use a craft knife or scissors to cut the vertical lines between the gate and praying John. Reverse the center crease between the slits you just made and crease the top and bottom of that section on the dotted lines so that the rectangles “pop up.”

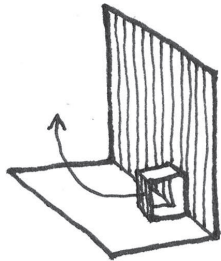

Step 1

2. Cut out the lame man and fold his feet up 90 degrees on the dotted line. Put glue on the bottom of his feet and on the gray rectangle by the gate. Press the back of the man's legs against the gray rectangle so that the crease at his ankles aligns perfectly with the crease at the bottom of the gray rectangle. When that glue is dry, push the man down to a sitting position against the wall and crease his waist so that it aligns with the crease in the gate picture. Now he can “sit down” to beg alms from passersby and “stand up” when he is healed by the Spirit.

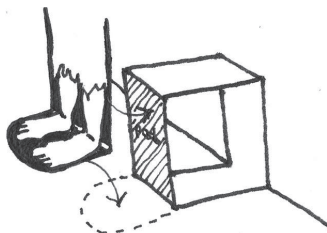

Step 2



3. Fold the front and back of Peter together on the center dotted line and cut him out, paying attention to both sides as you go. Glue his front and back together. Fold Peter's feet up 90 degrees on the dotted line, then cut on the white line to separate Peter's feet and legs. Put glue on the bottom of Peter's feet and press them to the ground near the lame man, with one foot slightly ahead of the other. This will keep Peter standing upright. If you wish, bend his extended arm toward the lame man.



Step 3

4. *Optional:* Cut out the illustrated verse and paste it to the picture.

**MAKE IT SIMPLE:** Copy, cut, and crease ahead of time. Consider using double-sided tape to attach Peter to the ground as the tape does not require time to dry.

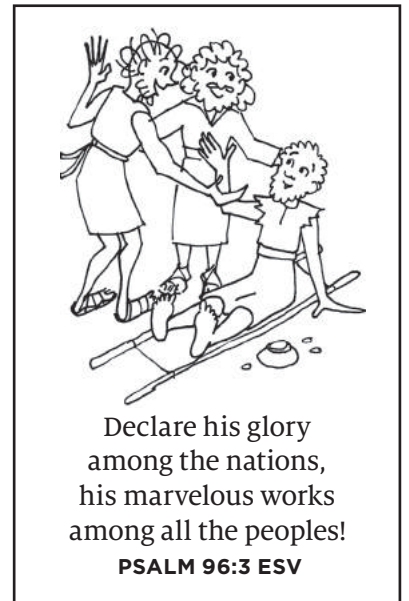

lame man template

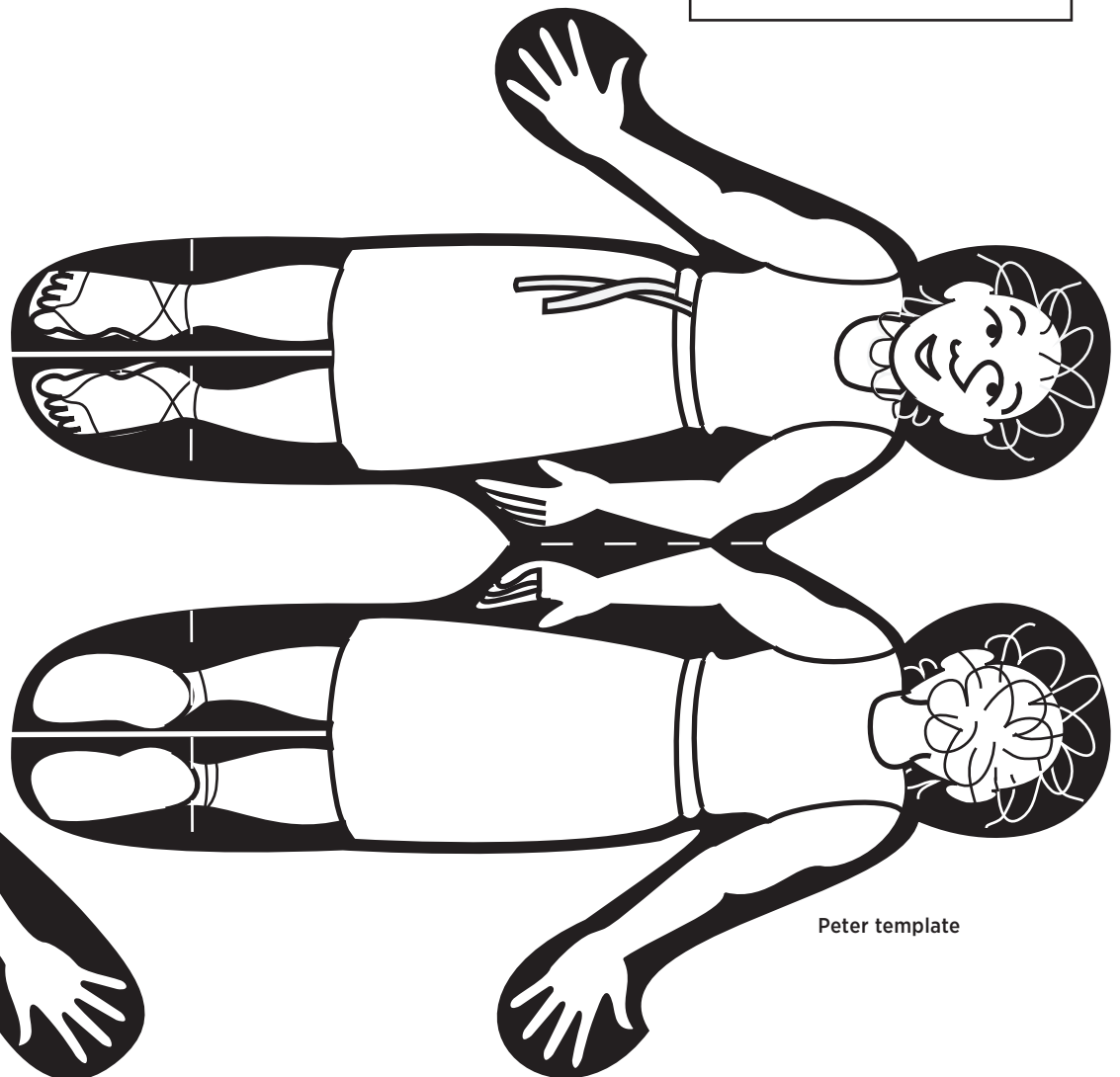

Peter template



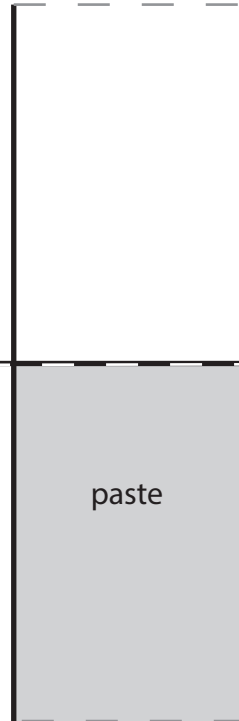

paste

## STEPHEN STANDS FIRM

*Acts 6:8-7:60*

Stand firm in the faith, act like men, be strong.  
 (1 Cor. 16:13)

### SUPPLIES:

(to make one craft)

- 2 sheets of white cardstock
- templates of an open Bible (the full page) and Stephen speaking to a crowd (see pages 226-27)
- crayons or markers
- scissors
- glue or double-sided tape
- optional*: black cardstock, poster board, or paper



### INSTRUCTIONS:

**PREP STEP:** Copy the two templates onto white cardstock.

1. Color the Stephen and the Bible pictures and cut out Stephen and the crowd.
2. Fold the bottom tab of the Stephen panel back on the horizontal dotted line, then fold the panel inward on the vertical dotted line. Unfold the panel and slit the crease on the solid line that runs across the bottom tab. Also cut a tab along only the solid-lined outer edges of Stephen's feet. The bottom tab has now been cut into four tabs, with Stephen's feet being one of those tabs.

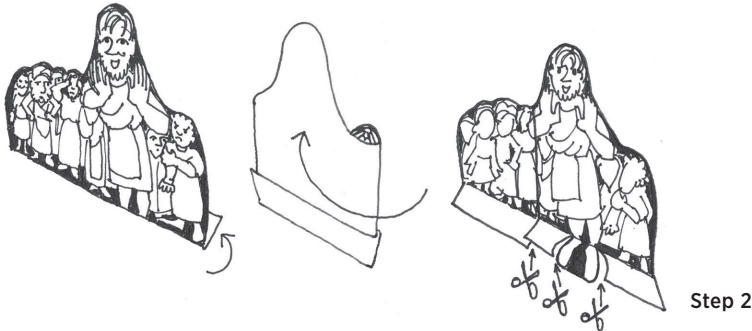

3. *Optional*: Glue the Bible sheet onto black cardstock, paper, or a piece of poster board cut to size, with or without trimming away the black border around the open Bible first.

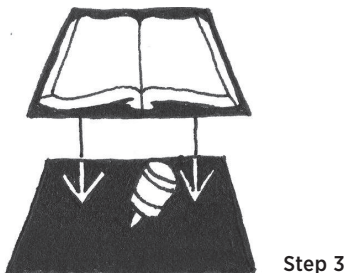

4. Fold the Bible page inward in half crosswise and crease well, then unfold it again. Fold Stephen's feet up in front of him, then refold his panel inward. Put glue or double-sided tape on the three tabs as marked. Carefully glue the tabs that were next to Stephen's feet onto their matching shapes in the Bible panel, so that the corner of one exactly touches the inner crease of the "Bible" (regardless of whether the crease fell exactly on the dotted line). Fold the Bible closed so that the final glued tab sticks to the empty left side of the Bible page. Press down to strengthen the adhesion, then slowly open the Bible to find Stephen standing with the crowd behind him. Glue Stephen's feet down in front of him.

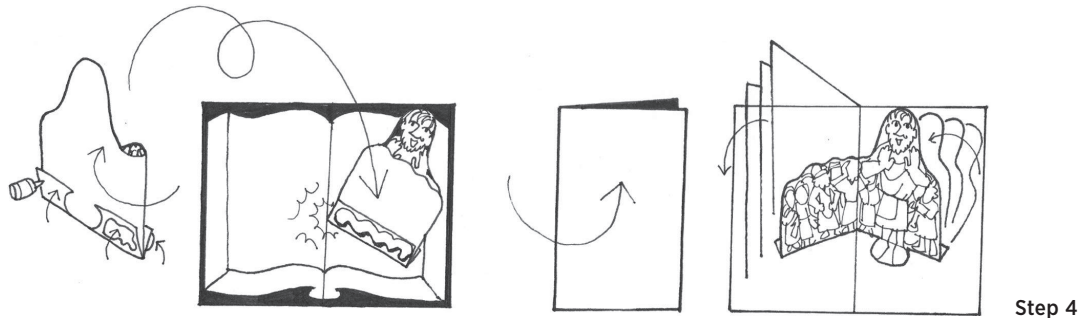

5. *Optional:* Cut out and glue the illustrated verse onto the craft. If you used the *optional* black "cover," write "Bible" on the front in white or gold crayon or oil pastel.

**MAKE IT SIMPLE:** Cut and crease ahead of time. Also, skip Step 3.

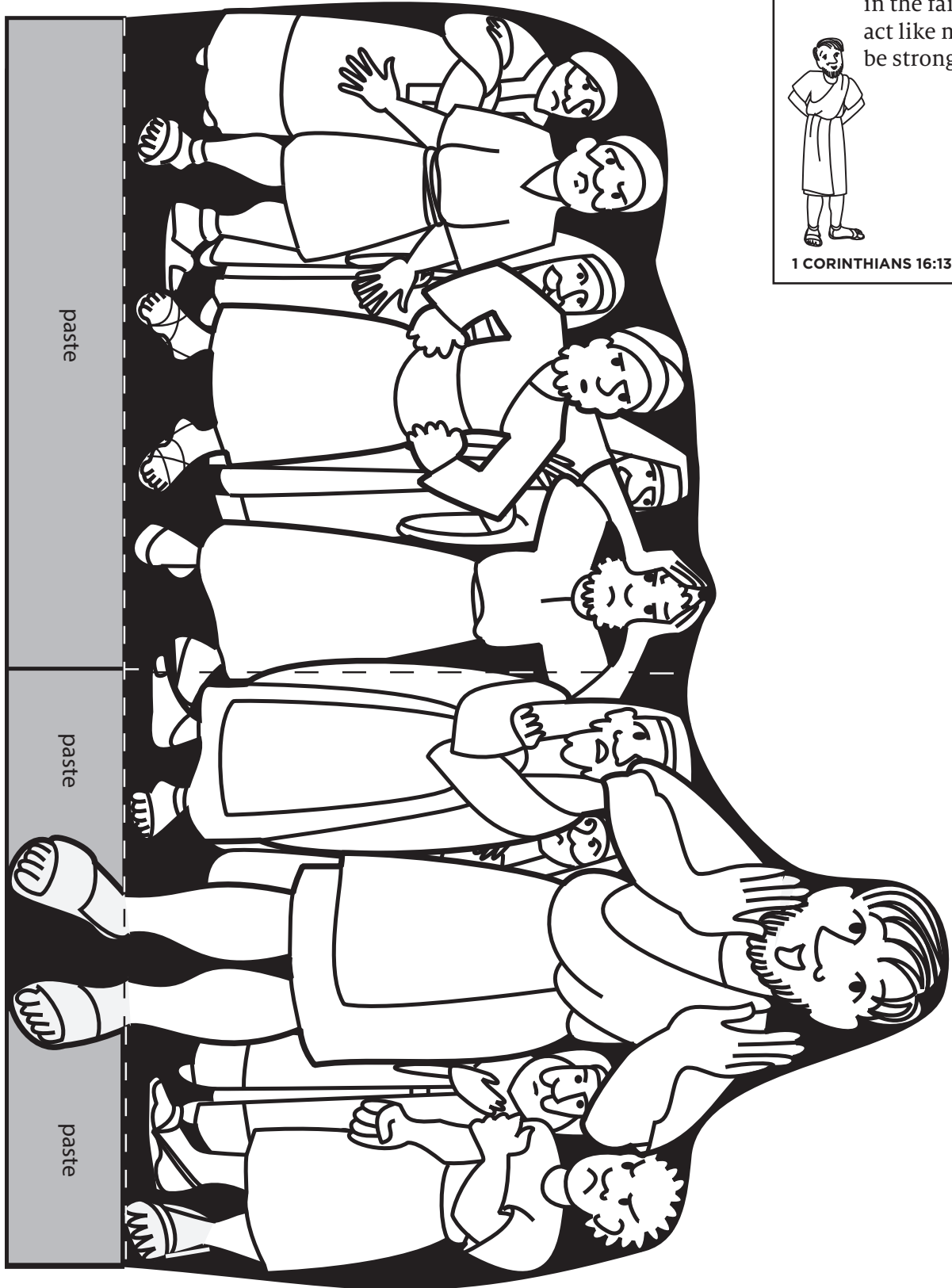

Stand firm  
in the faith,  
act like men,  
be strong.



1 CORINTHIANS 16:13 ESV

Stephen speaking to a crowd template

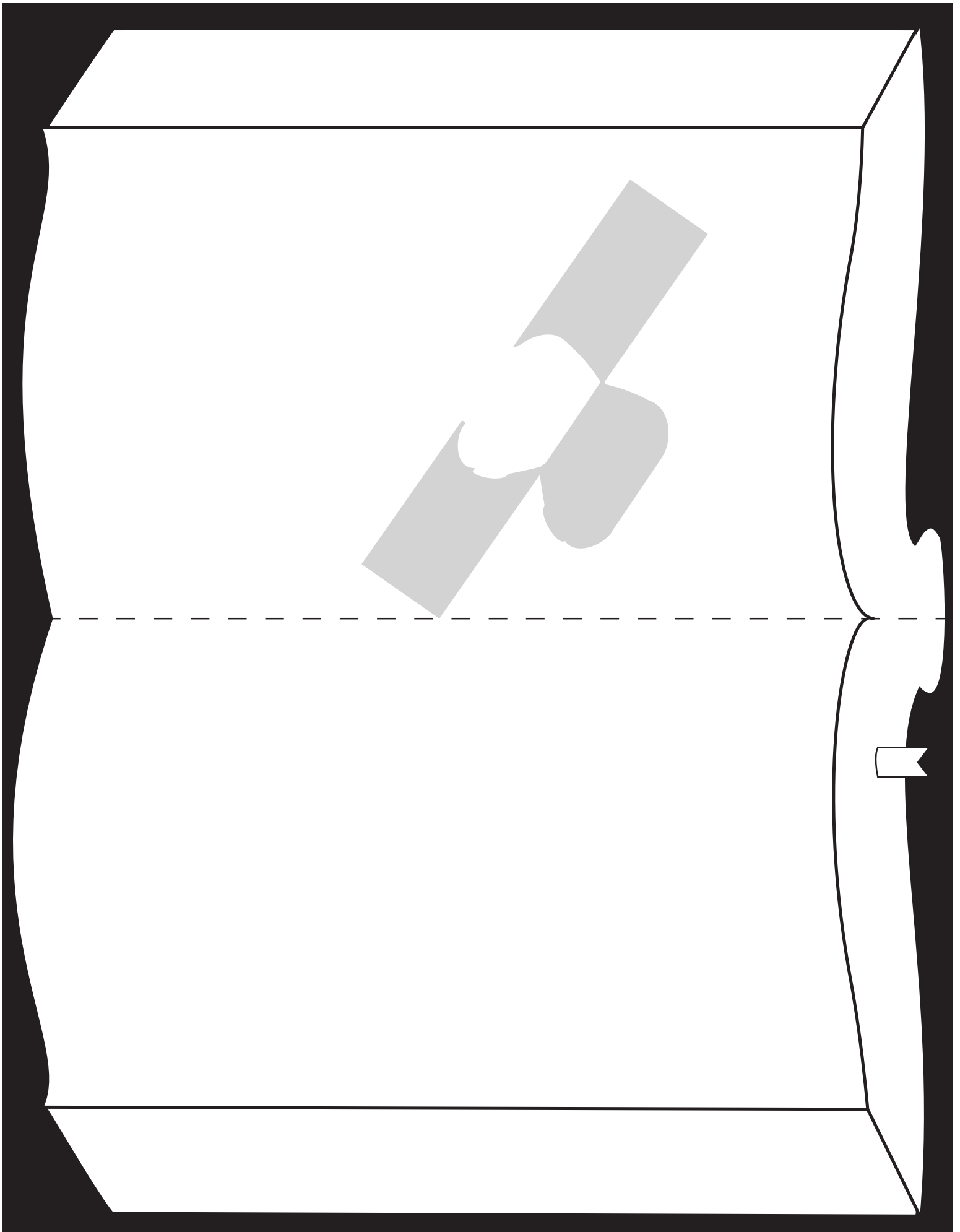

## GOD USES PHILIP TO TEACH A MAN FROM ETHIOPIA

Acts 8:26-40

Go therefore and make disciples of all nations.  
(Matt. 28:19)

### SUPPLIES:

(to make one craft)

- 1 sheet of white cardstock
- optional*: 1 sheet of gold cardstock
- templates of the chariot and of Philip with the Ethiopian (see page 229)
- crayons or markers
- scissors
- glue
- tape

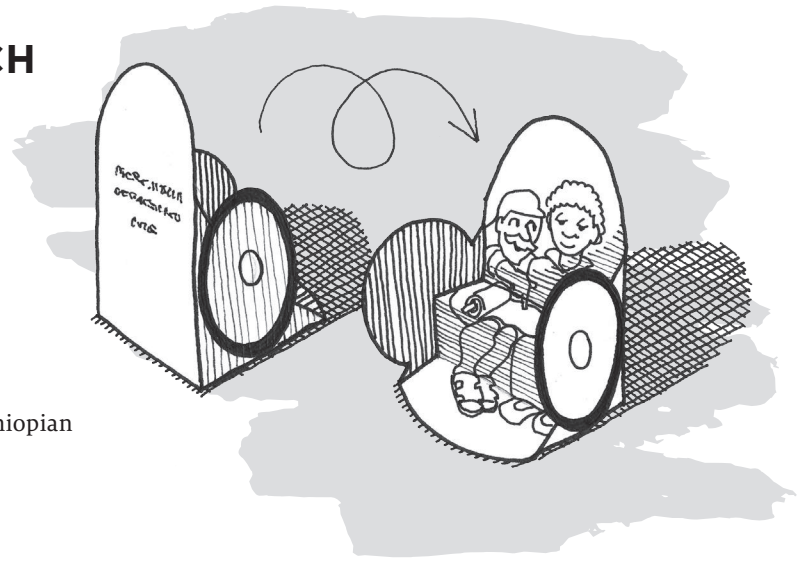

### INSTRUCTIONS:

**PREP STEP:** Copy the men and the chariot templates onto white cardstock. *Optional for Step 1:* Copy the template of the chariot onto gold cardstock (instead of onto white).

1. Color Philip, the Ethiopian, and the chariot and cut them out. Make sure to also cut the solid-line slits above the wheels on the chariot.
2. Flip the chariot over and fold inward on the five dotted lines. Apply paste to the two panels so marked, and aligning the edges, especially at the front of the chariot, attach the pasted panels to the backs of the wheel panels. Add tape to reinforce the edges if you wish.

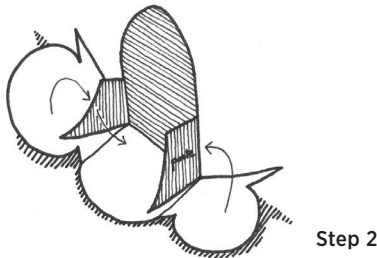

3. Accordion-fold the panel of Philip and the Ethiopian so that they are in a sitting position, and paste them inside the chariot.

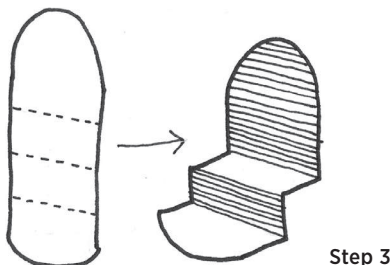

**MAKE IT SIMPLE:** Cut and crease the chariot ahead of time, but unfold to color.

**MAKE IT AMAZING:** If you make the chariot from gold paper, cut out Philip, the Ethiopian, and their bench (the two horizontal sections marked off with dotted lines) as one piece, separate from the rest of their bullet-shaped panel. Accordion-fold and glue them into the chariot by their feet and torsos. This will allow the gold chariot color to show all around them.



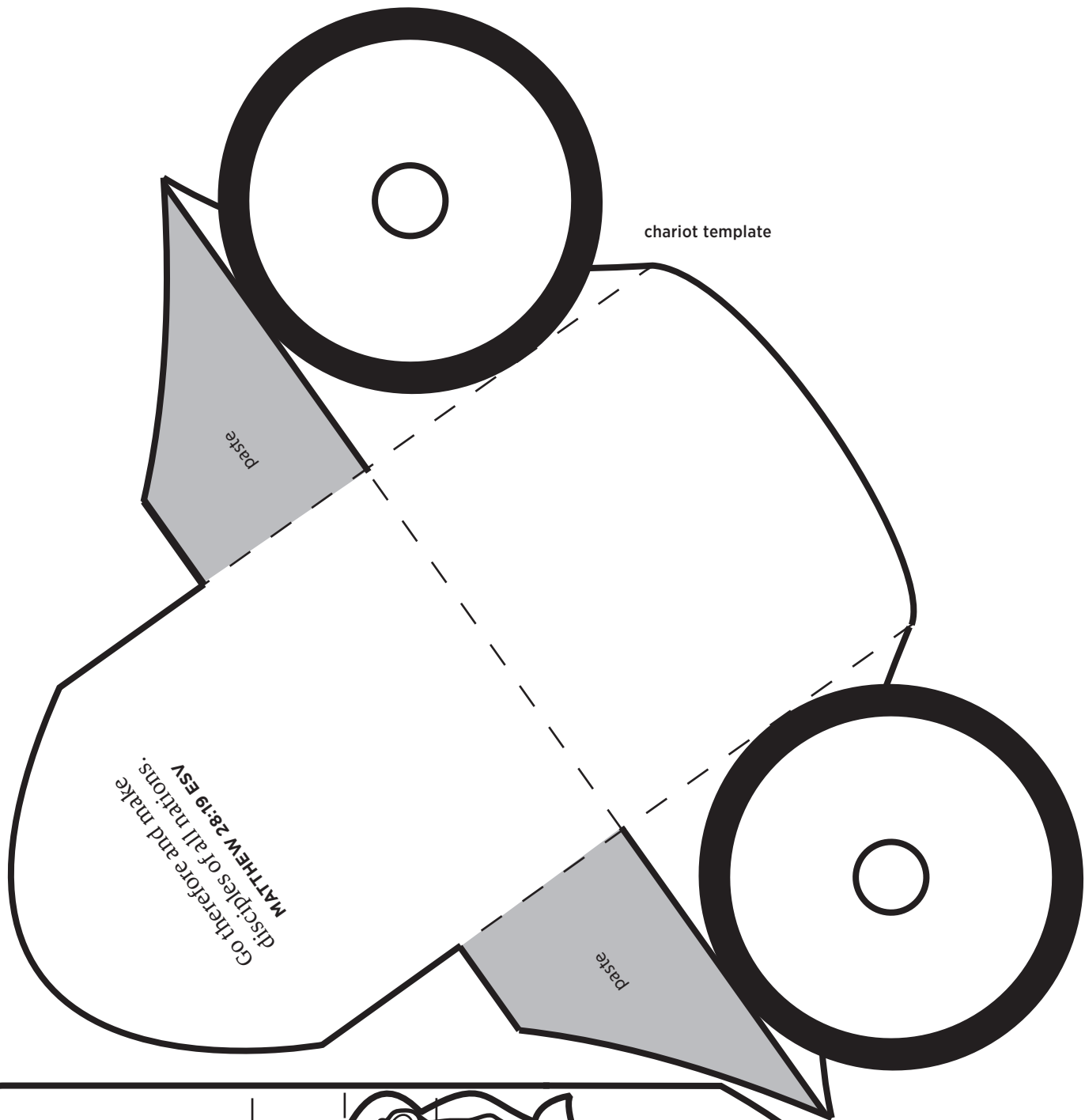

chariot template

Go therefore and make  
disciples of all nations.  
MATTHEW 28:19 ESV

paste

paste

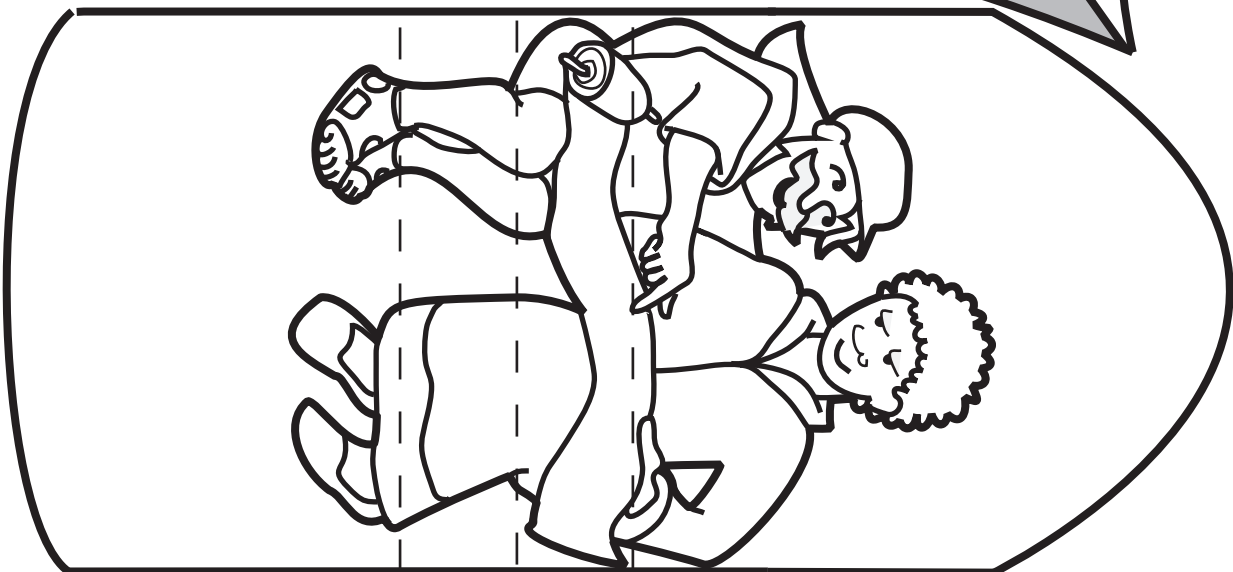

Philip with the Ethiopian template

## GOD GIVES PETER A VISION

*Acts 10:1-11:18*

In every nation anyone who fears [God] and does what is right is acceptable to him. (Acts 10:35)

### SUPPLIES:

(to make one craft)

- 1 paper lunch sack
- scissors
- crayons or markers
- 1 sheet of white cardstock
- templates of Peter and of the three men at the gate (see page 232)
- glue
- tape
- 4-inch square of white- or solid-colored fabric
- assorted small plastic animals, or animal crackers, or the template of animals

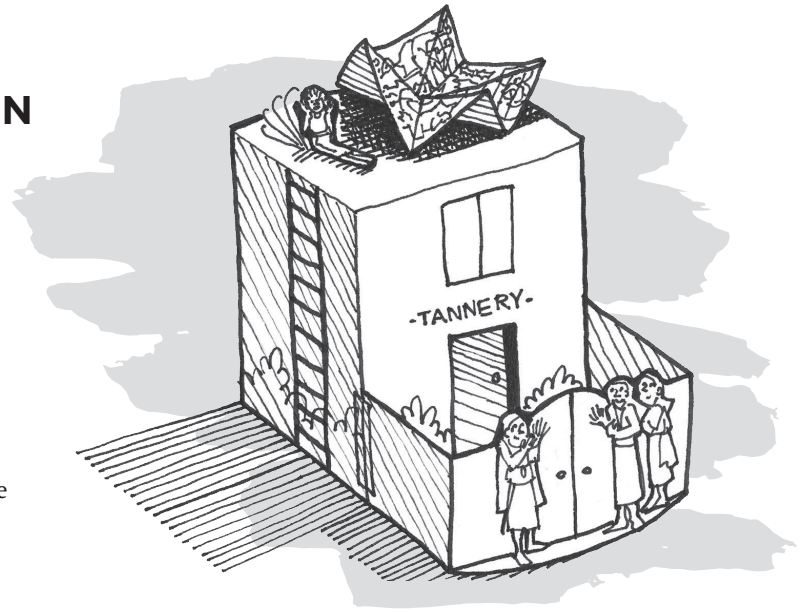

### INSTRUCTIONS:

**PREP STEP:** Copy the templates of double-sided Peter and the three men at the gate (along with its 11-inch fence) onto white cardstock.

1. Fold a paper lunch sack in half crosswise and crease well. Open the bag and push the top half down inside the bottom half, smoothing out the sides and re-creasing the edges. Now it is half as tall as it was originally, and its walls are double-thick. Turn it upside down to make a house, and cut the top and one side of a  $2\frac{1}{2} \times 1\frac{1}{2}$ -inch door into one of the house's long sides. Crease the door open and paste its two plies together. Draw windows, a staircase or ladder, a sign that reads "Simon the Tanner" or "Tannery," shrubbery, and anything else you'd like on the walls of the house.
2. Color the pictures of Peter and the three men (including the gate and fence) and cut them out. If your bag house is 5 inches wide, fold the fence 90 degrees on the two vertical dotted lines as well as on the horizontal dotted line at the bottom. Tape the edges of the fence to the front edges of your house to form a fenced-in front yard. If your bag house is not 5 inches wide, experiment to find the right places to fold your fence so that it fits your house.
3. Fold Peter on the vertical dotted line to bring his back side behind his front side, then paste him closed. Fold his legs up 90 degrees in front of him and glue the back of his legs to the roof of your house, over to one side to make room for the big sheet. If you glue only his legs down, he will be able to lie down and sit up.

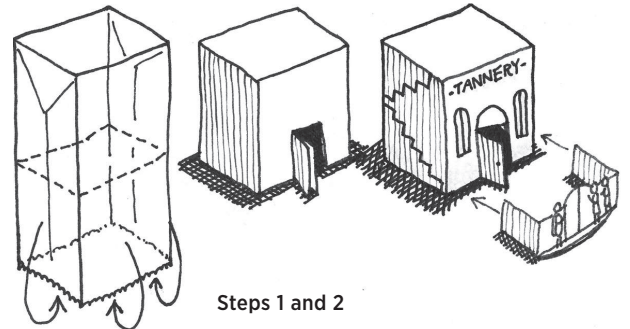

4. Cut a 4-inch square of fabric and glue it to the rooftop next to Peter as though it has just landed there. Glue a variety of plastic or cracker animals onto it. (*Alternately:* Cut out the animal-filled picture and color it. Fold it in half and lightly crease it in both directions, then open it and fold it in half the other way and crease that fold gently in both directions. Open it again, fold it in half corner-to-corner, crease both directions lightly on the diagonal, then fold it on the other diagonal and lightly crease both directions. Now arrange the creases so that the four corners are all touching at the top and the four edges between the corners bow outward between them. Unfold the sheet halfway, so that it looks like it is suspended by its four corners but open enough to see all the animals printed inside, and glue it by two edges to the rooftop.) As Peter considers the “vision,” Cornelius’s three servants are arriving at the gate to ask for him.

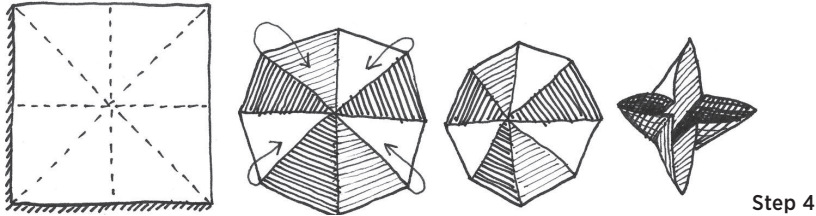

Step 4

5. *Optional:* Cut out the illustrated verse and glue it to the house.

**MAKE IT SIMPLE:** Fold the bags and cut a door in each house before class. Cut and fold Peter, the fence with the men, and, if you are using it, the printed sheet full of animals.



animals template



Peter template

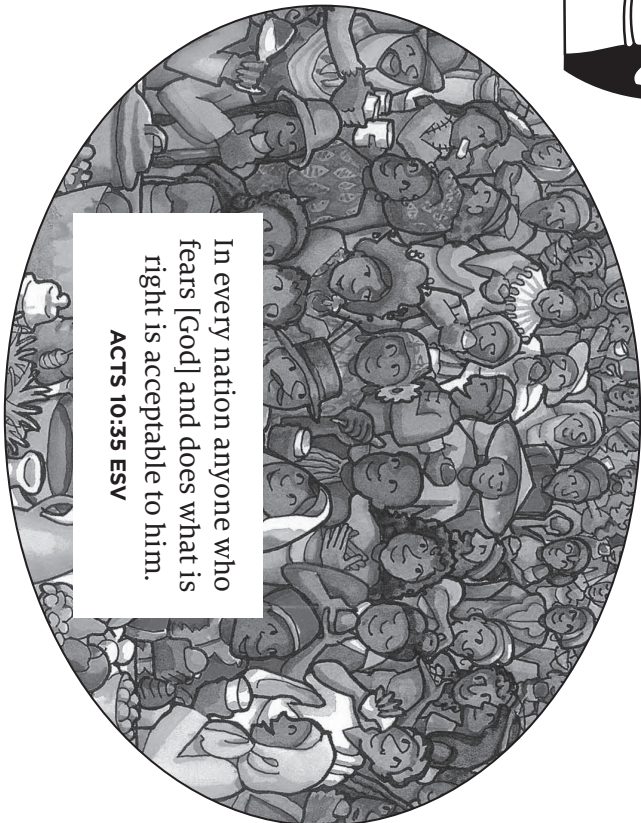

In every nation anyone who fears [God] and does what is right is acceptable to him.  
**ACTS 10:35 ESV**

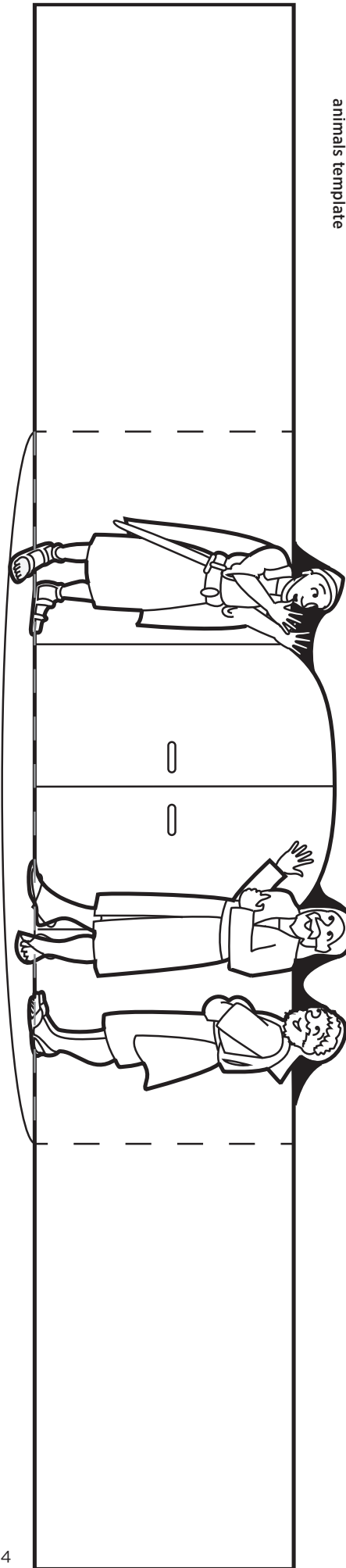

three men at the gate template

## LYDIA FOLLOWS JESUS

*Acts 16:11–15, 40*

Faith comes from hearing, and hearing through the word of Christ. (Rom. 10:17)

### SUPPLIES:

(to make one craft)

- a 9 x 12-inch sheet of purple felt, either soft or stiffened
- hot-glue gun or needle and purple embroidery thread or sewing machine with purple thread
- fabric markers or regular markers
- optional*: decorations, ideally purple—buttons, ribbon, stickers, etc.
- optional*: glue
- scissors
- template of Lydia with Paul, Timothy, and Silas (see page 235)
- 1 sheet of white cardstock
- optional*: crayons

### INSTRUCTIONS:

**PREP STEP:** Copy the Lydia template onto white cardstock.

1. With an adult's help, create a pouch from a sheet of purple felt by folding the bottom 5 inches up and then closing the sides with strips of hot glue or lines of stitching. With the top 2 inches of felt, form a flap that folds down over the pouch to close it. If you used stiffened felt and you want the pouch to be a purse, sew or hot glue the ends of a long piece of ribbon to the top corners of the pouch.

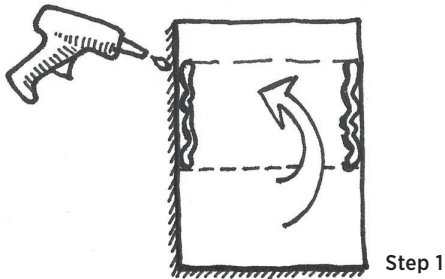

2. Decorate the pouch with markers and, if you wish, decorate it with stickers and/or glued-on buttons, jewels, ribbon, etc.
3. Color the picture of Paul and his friends sharing the gospel with Lydia, cut it out, and keep it inside your purple pouch.

**MAKE IT SIMPLE:** Make the undecorated pouches ahead of time, and cut any ribbon or similar notions to size before class. Have the pictures cut to size and ready to color.

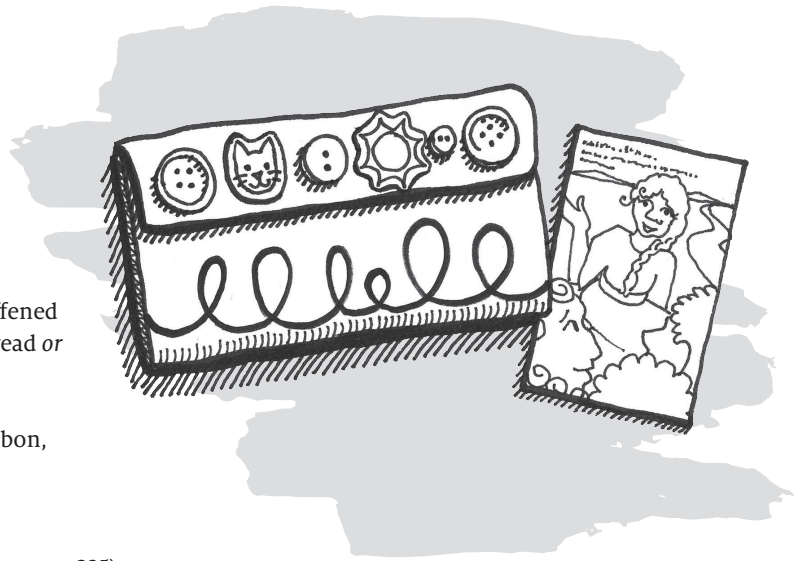

**MAKE IT AMAZING:** Instead of using felt, weave your own sheet of purple “fabric” from one purple paper and one or more additional sheets of paper in different shades of purple, red, and/or blue. Fold the purple sheet in half crosswise and cut parallel lines, 1 inch apart, from the crease to within ½ inch of the opposite edge. Cut 1-inch strips crosswise from the other paper(s). Unfold the purple paper and weave a strip across its width, under and over the purple bands. Push it to one end of the purple paper, then weave another strip across, under the bands the last strip went over, and over the bands the last strip went under. Push it snug against the first strip, then weave a third, under and over the same bands as the first strip. Continue in this manner until the purple paper is full, which will probably take nine strips. Now proceed to make your pouch, securing the edges with tape. The section you fold up will contain three strips, and the top flap will contain two strips. You may need to trim your picture of Lydia a little to fit it into your pouch.

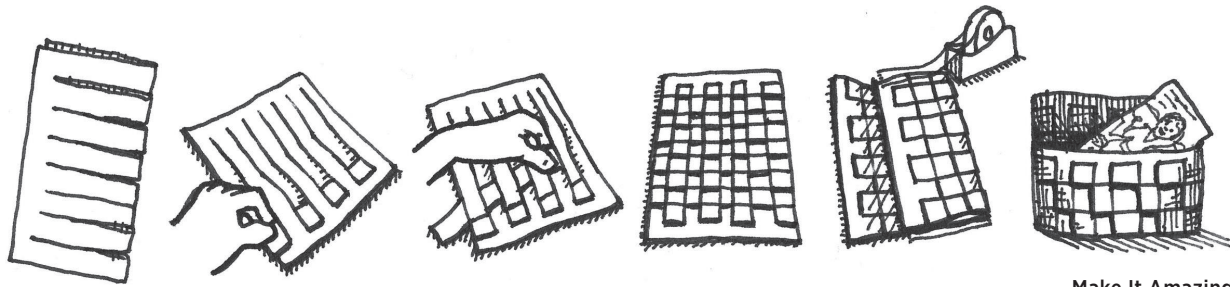

Make It Amazing



Faith comes from hearing, and hearing  
through the word of Christ.

**ROMANS 10:17 ESV**



Lydia template

## GOD FREES PAUL AND SILAS AND SAVES A JAILER

Acts 16:16-40

“Sirs, what must I do to be saved?” . . . “Believe in the Lord Jesus, and you will be saved.” (Acts 16:30-31)

### SUPPLIES:

(to make one craft)

- 2 toilet-paper tubes or 1 paper-towel tube
- tape
- 2 sheets of white paper or cardstock
- scissors
- optional: paper cutter
- 2 small square templates of Paul, Silas, and the Philippian jailer (see page 237)
- crayons or markers
- glue
- optional: stickers
- optional: adhesive hook-and-loop fastener such as Velcro®

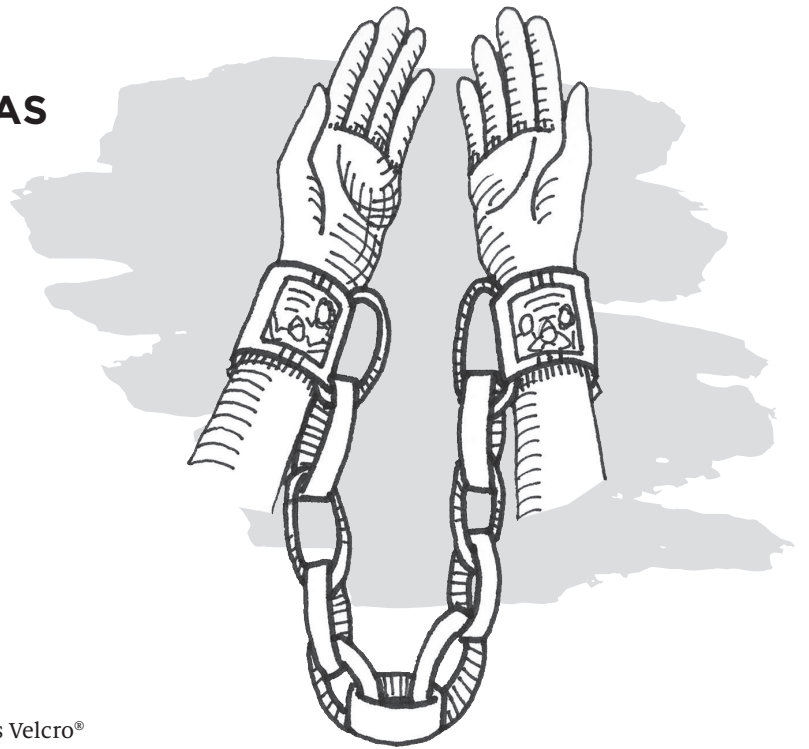

### INSTRUCTIONS:

*Paul and Silas were set free from their bonds during the earthquake, and the jailer was set free from bondage to sin and death when he believed.*

**PREP STEP:** Copy the two templates of Paul, Silas, and the Philippian jailer onto white cardstock or paper.

1. Cut two toilet-paper tubes (or one paper-towel tube) into four 2-inch-long cylinders. Make a single cut up the length of each little tube to open it. Overlap the lengths of two open tubes by an inch and tape them together to form one long strip that coils in on itself. Tape the remaining two little tubes together the same way. These should now be “cuffs” that curl around your wrists or ankles.

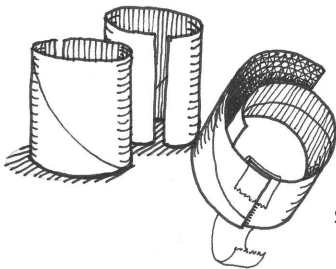

Step 1

2. Cut a sheet of white paper or cardstock crosswise into eleven strips, each 1 inch wide. (Use a paper cutter if you have access to one.) Curl the first strip into a circle and tape its ends together, overlapping slightly. Thread the second strip through the circle and tape its ends together. Thread the third strip through the second circle and tape its ends together. Continue this way with all the strips until your paper chain has eleven links. Thread the end links through each of the two cuffs.

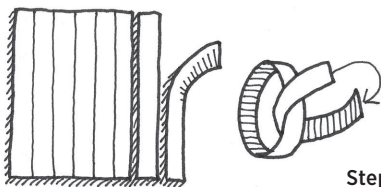

Step 2

3. Color and cut out the square pictures of Paul, Silas, and the Philippian jailer. Glue one square onto each of the cuffs, over the seam created by joining the tube sections (this way the square will not be covered when you wrap the cuff around your limb).

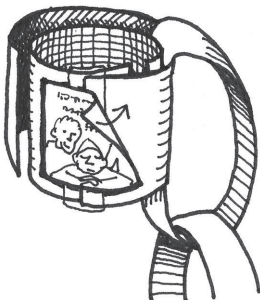

Step 3

4. The cuffs will stay on moderately well just from being curled, but if you want them to stay on securely, close them with Velcro® or simply with a piece of tape that can be removed easily.
5. *Optional:* Decorate the cuffs and chains with crayons, markers and/or stickers.

**MAKE IT SIMPLE:** Create the cuffs and cut the chain strips ahead of time. Have the squares cut out and ready to color. If there are not enough tape rolls for each child to have his own, put eleven pieces of tape at each student's workspace. *Alternately*, if your students are very young and/or you have a high student-to-teacher ratio, you may wish to chain all but the last three links for each child ahead of time.

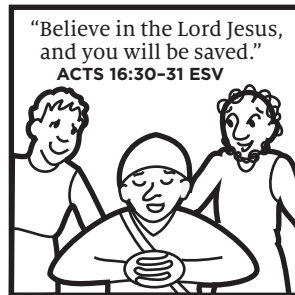

Paul, Silas, and the Philippian jailer templates

## THE WHOLE ARMOR OF GOD

*Ephesians 6:10–20*

Put on the whole armor of God, that you may be able to stand against the schemes of the devil. (Eph. 6:11)

### SUPPLIES:

(to make one craft)

- an 11 x 14-inch poster board (you can make four of these from a standard 22 x 28-inch sheet of poster board)
- scissors
- aluminum foil
- hot-glue gun or packing tape
- templates of soldier and of various pieces of armor (see pages 239–40)
- 2 sheets of white copy paper
- crayons or markers
- glue

### INSTRUCTIONS:

**PREP STEP:** Copy the templates of the soldier and all his armor onto white paper.

1. Cut the bottom corners off your poster board to create a simple shield shape.

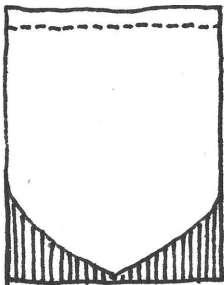

Step 1

2. Cut a 1-inch strip off the top, from which to make a handle.
3. Cover the shield with aluminum foil, smoothing it on the front, creasing the foil where it wraps around the edges of the board, and securing the ends on the back with packing tape or hot glue. (Be careful—aluminum conducts heat!)
4. Cut the strip of poster board to handle length, and use packing tape or hot glue to secure its ends to the back of your shield.

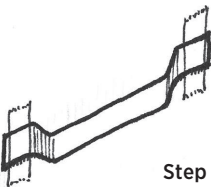

Step 4

5. Color the soldier and armor pictures and cut them out. Glue the soldier to the front of your “shield of faith.” Carefully place each piece of armor onto the soldier and glue it into place as well.
6. *Optional:* Cut out the verse and glue it to your shield.

**MAKE IT SIMPLE:** Construct the shields ahead of time, and cut out each soldier and his pieces of armor.

**MAKE IT AMAZING:** Laminate the pieces of armor (or envelop them in clear packing tape or clear Con-Tact™ paper) after you have colored them, and attach them to the soldier with Velcro™. This way they can be taken off and on repeatedly.

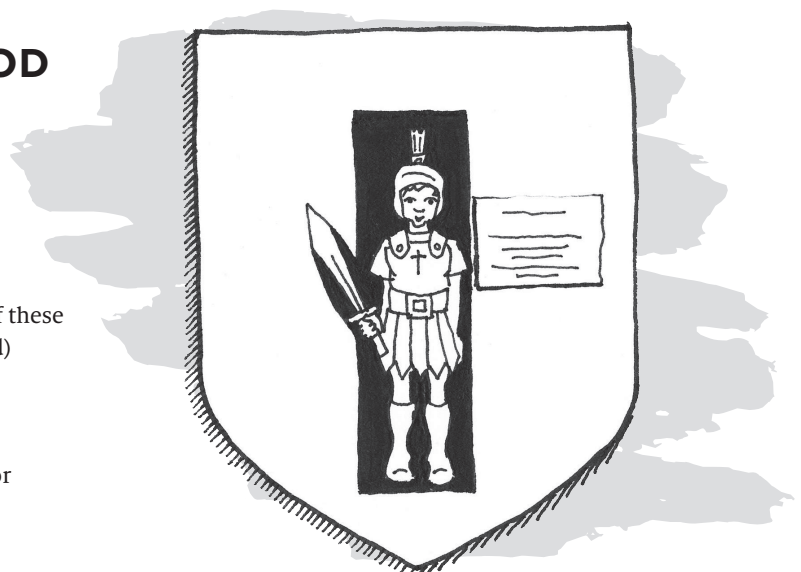



soldier template



sword template

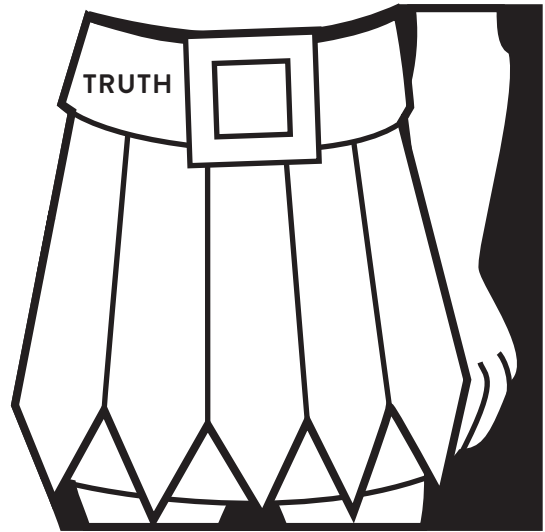

## Shield of Faith

Put on the whole armor of God,  
that you may be able  
to stand against  
the schemes of the devil.

**EPHESIANS 6:11 ESV**



## THE FRUIT OF THE SPIRIT

*Galations 5:16–26*

The fruit of the Spirit is love, joy, peace, patience, kindness, goodness, faithfulness, gentleness, self-control. (Gal. 5:22–23)

### SUPPLIES:

(to make one craft)

- 2 sheets of white cardstock
- templates of the dove with branch (the full page) and of nine labeled fruits (see pages 242–43)
- 1 large basket-style coffee filter (white)
- scissors
- optional*: craft knife such as X-Acto™
- crayons or markers
- optional*: colored copy paper
- glue

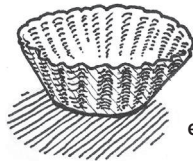

example of coffee filter needed

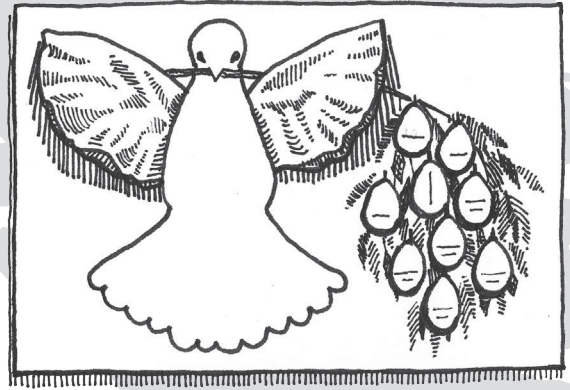

### INSTRUCTIONS:

**PREP STEP:** Copy the full-page dove-with-branch template onto white cardstock. Choose a set of nine fruits and copy them onto white or colored paper.

1. Use a craft knife or scissors to slit the solid gray lines at the dove's sides. Fold a large coffee filter in half, place it behind the dove with the crease at the top, and pull the left and right tips of the folded filter forward through the slits to become the dove's wings.
2. Color the nine fruits. They can be the same or any combination of different colors. Cut them out and paste them onto the branch.

**MAKE IT SIMPLE:** Instead of cutting the fruit all the way out, simply cut the paper into small rectangles that contain the fruit pieces.

**MAKE IT AMAZING:** Cut the dove out completely, including the bottom sides and edge of its beak. Paste the dove, with its coffee-filter wings, to a blue backing sheet. Glue a long thin twig under its beak, then glue green paper leaves to the twig. Glue the fruit to the twig and leaves.

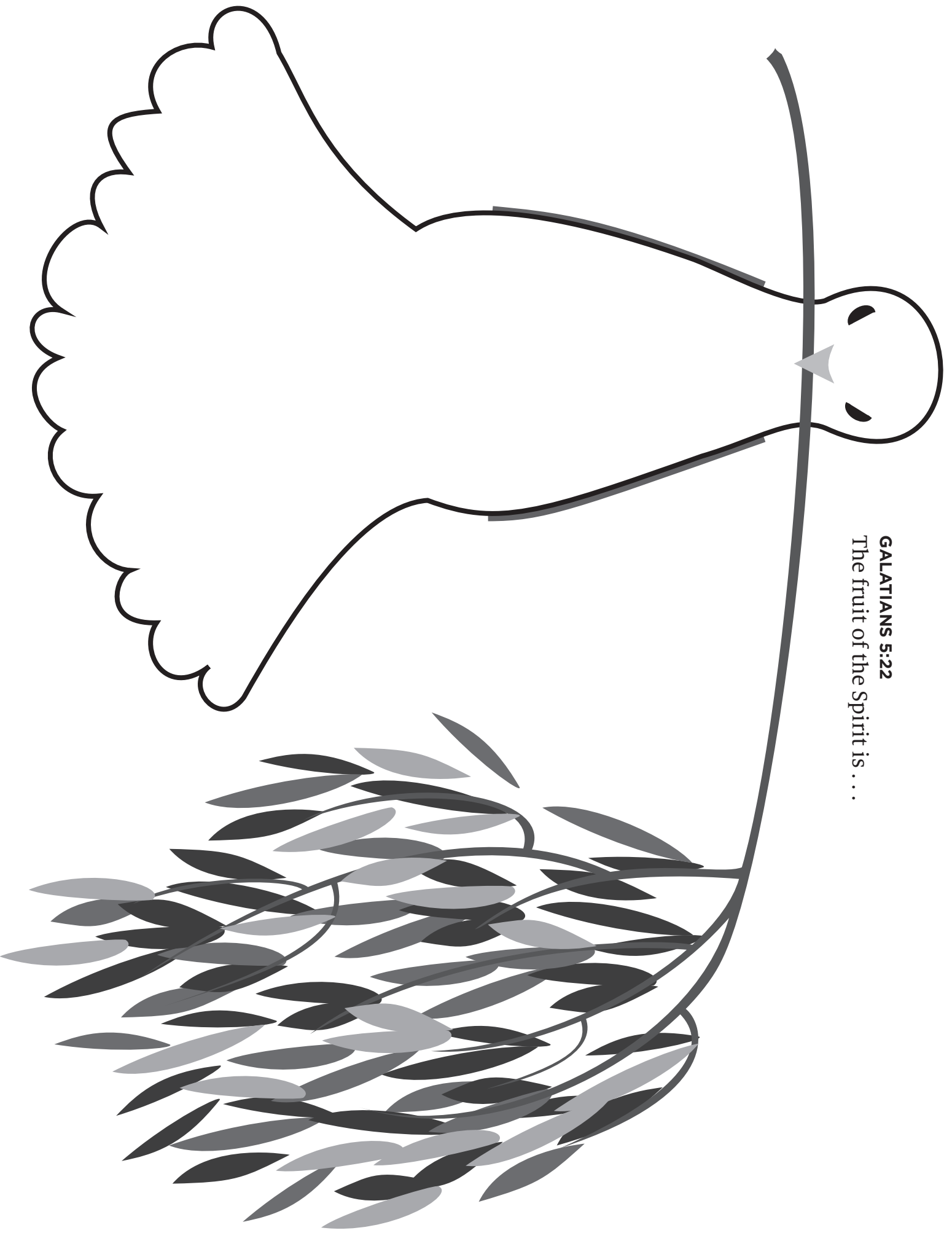

**GALATIANS 5:22**  
The fruit of the Spirit is . . .

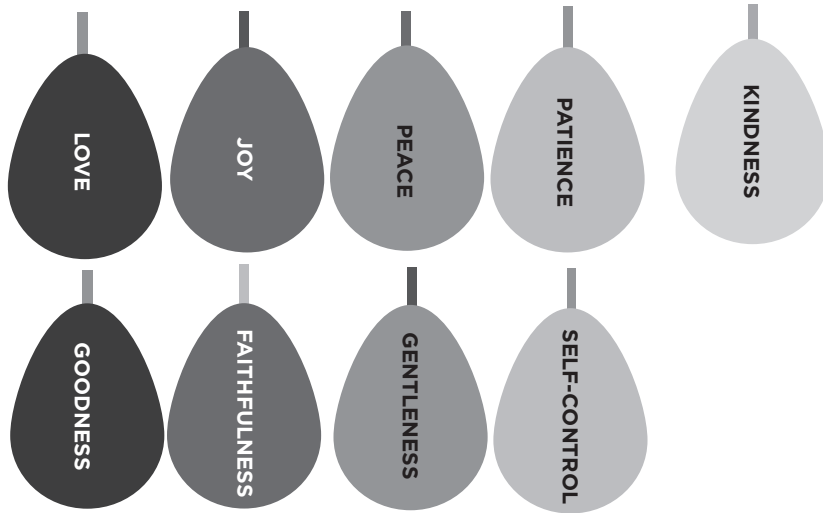

nine labeled fruits templates

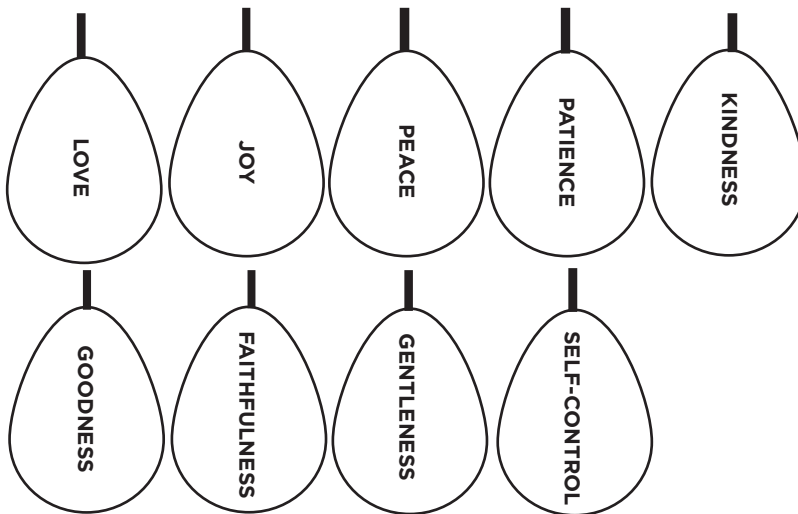

nine labeled fruits templates

## GOD DELIVERS PAUL FROM ENEMIES IN DAMASCUS

*Acts 9:19–25*

For the sake of Christ, then, I am content with weaknesses, insults, hardships, persecutions, and calamities. For when I am weak, then I am strong. (2 Cor. 12:10)

### SUPPLIES:

(to make one craft)

- 1 sheet of white cardstock
- template of Paul seated (see page 245)
- crayons or markers
- scissors
- glue
- a 6-inch paper plate
- optional*: hot-glue gun
- hole punch
- 20 inches of twine or rope-colored yarn

### INSTRUCTIONS:

**PREP STEP:** Copy the template of double-sided Paul onto white cardstock.

1. Color Paul and fold him on the dotted line. Cut him out, watching both sides as you go. Paste the fold closed to make Paul double-sided.
2. Cut a 6-inch paper plate in half and (with an adult) hot glue the halves together only by the rims to form a semi-circular “basket.” (If you use regular glue instead, let it dry overnight.) Use a hole punch to make one hole near each end of the straight edge. Thread the ends of a 20-inch length of twine or rope-colored yarn through each hole and tie them off. Color the basket if you wish.
3. Place Paul into the basket, ready for the disciples to lower him from the city walls of Damascus.
4. *Optional*: Cut out and paste the illustrated verse to the side of the basket.

**MAKE IT SIMPLE:** Glue and hole punch the plates before class, also tying the twine for very young students. Cut out and crease Paul but don’t paste him shut until he has been colored.

**MAKE IT AMAZING:** Punch holes at 1-inch intervals all around the curved rim of the basket, then lace the twine through all the holes, passing around the outside of the basket each time and entering each hole from the same side.

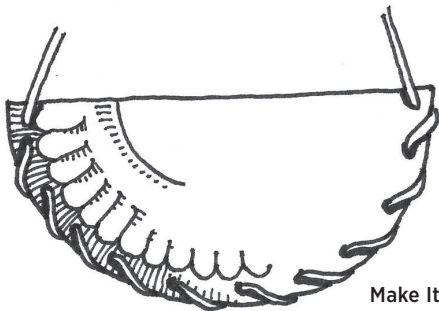
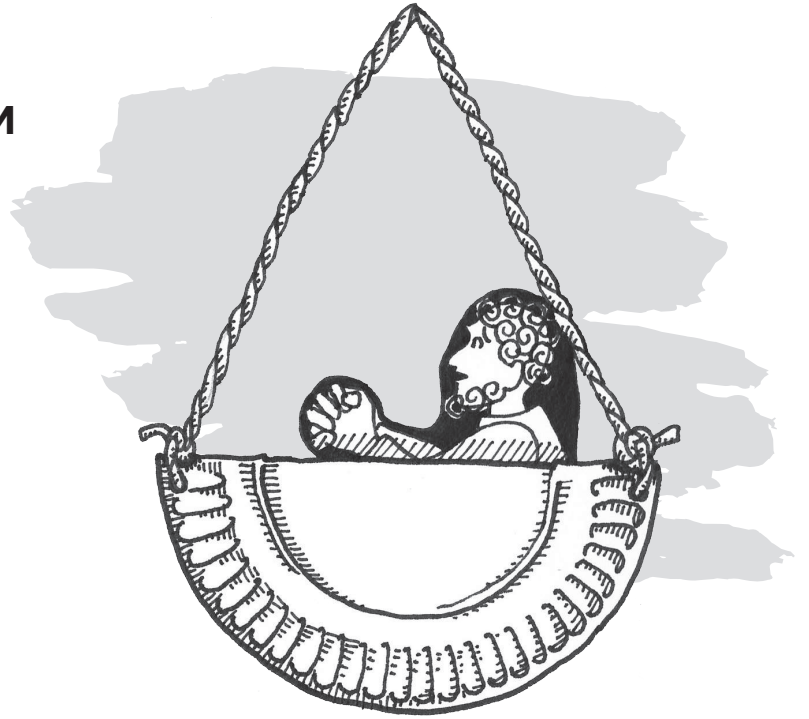

Make It Amazing

For the sake of Christ, then, I am content with weaknesses, insults, hardships, persecutions, and calamities. For when I am weak, then I am strong.

**2 CORINTHIANS 12:10 ESV**



Paul seated template

## GOD DELIVERS PAUL FROM A SHIPWRECK

*Acts 27:1-28:10*

Deal bountifully with your servant, that I may live and keep your word. (Ps. 119:17)

### SUPPLIES:

(to make one craft)

- 2 sheets of blue cardstock or paper
- 1 sheet of brown paper
- 1 sheet of white paper
- scissors
- crayons or markers
- glue
- 1 brass fastener
- template of swimming survivors (see page 247)

### INSTRUCTIONS:

**PREP STEP:** Copy the shipwreck survivors template onto white paper.

1. Cut a 6 x 10-inch rectangle from blue paper and scallop one long edge to look like waves. Cut a circle with a 4-inch diameter from another sheet of blue paper. Find and mark the circle's center.
2. Trace your hand on a sheet of brown paper with fingers spread as wide as possible. Cut out the hand shape, rounding the area between the thumb and pinky so that it looks like a great ship with three tall masts. Cut three rectangle sails from white paper, sized to fit your finger "masts," and glue them on. Glue the bottom curve of the ship to an edge of the blue circle so that they barely overlap.
3. With the wave edge up, place the ship so that its bottom edge is just below wave line, 6 ½ to 7 inches from the left edge of the "water" paper. Poke the points of a brass fastener through the center of the circle, then through the water behind it, maintaining its position with the ship mostly above the wave line.
4. Rotate the circle so that the ship sinks down well below the surface. Color and cut out the shipwreck survivors. Glue the bottom-left side of them to the blue circle so that they show the appropriate height above the surface of the waves, but won't show when the ship is pulled up again. Remove the brass fastener, place the circle with its ship and swimmers *behind* the water paper with the holes aligned, and replace the fastener through both layers, flattening the prongs in back. Start with the ship sailing, then make it "sink" and watch the survivors appear, swimming for the island of Malta.
5. *Optional:* Glue the bottom and side edges of the water to an 8 x 10-inch gray backing sheet for extra stability, and pass the fastener through it as well. This will allow you to draw the stormy sky, but will also make it a little harder to move the ship up and down.
6. *Optional:* Cut out the illustrated verse and glue it to the craft.

**MAKE IT SIMPLE:** Trace and label students' hands as they enter the classroom, then have an assistant cut them out during story time. Have a pile of pre-cut sails ready to be trimmed down to size for the smallest hands. Have circles cut with centers marked and rectangles cut and ready to be scalloped. You can also eliminate the wheel and just paste the ship in a sinking position and paste the swimmers in the water.

**MAKE IT AMAZING:** Combine pieces of blue paper to make the water piece twice as long, then make an island rising above the waves at the far right end.

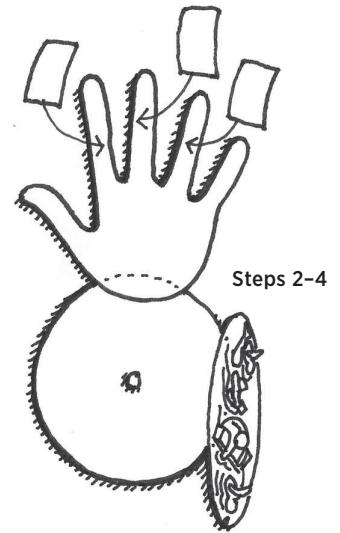
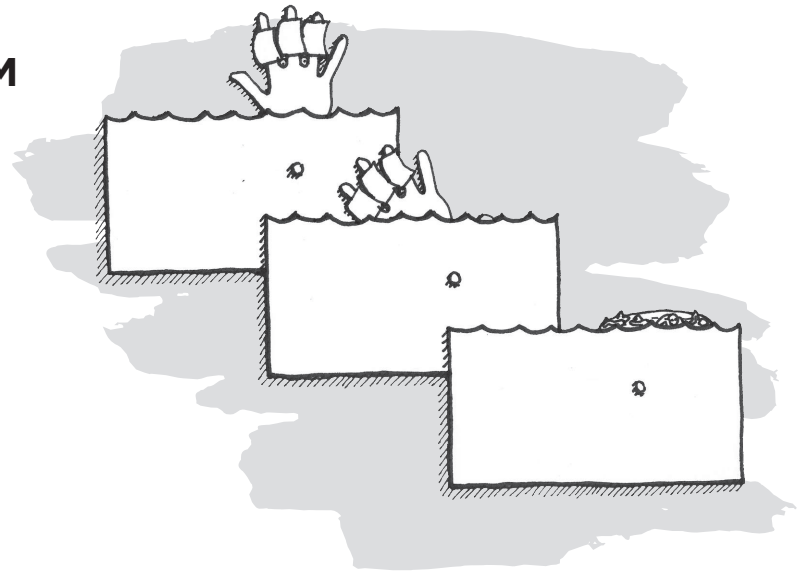





Deal bountifully with your servant,  
that I may live and keep your word.

**PSALM 119:17 ESV**



swimming survivors template

## GOD GIVES JOHN A VISION OF THINGS TO COME

*Revelation 4:1-11; 5:1-14; 7:9-17*

To him who sits on the throne and to the Lamb be blessing and honor and glory and might forever and ever! (Rev. 5:13)

### SUPPLIES:

(to make one craft)

- 2 sheets of white cardstock
- templates of throne, square pedestal, twenty-four elders, and lamb with scroll (see pages 250–51)
- crayons or markers
- scissors
- glue
- optional: 1 sheet of copy paper

### INSTRUCTIONS:

**PREP STEP:** Copy the four templates onto white cardstock. *Optional for Step 6:* Copy the illustrated verse.

1. Color the four pictures.
2. Cut out the large square pedestal and slit it on the four solid lines. Flip the printed side down and fold inward 90 degrees on all six dotted lines, creasing well. Form a cube by pasting the squares labeled **A** and **1** to the backs of those labeled **B** and **2**, aligning edges as you go. Next, paste the eagle and lion squares down onto the **B** and **2** squares.

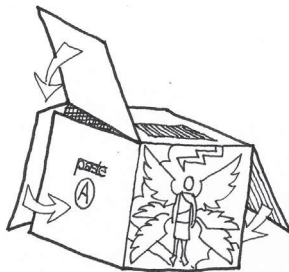

Step 2

3. Cut out the throne, fold inward 90 degrees on all eight dotted lines, and crease well. Paste the *back* of the dark-gray tab to the matching dark-gray shape where the seat meets the back of the throne, and press the tab there until the glue dries. Paste the backs of the light-gray tabs to the matching light-gray shapes on the sides of the throne just below the arm rests. For the first one, you can reach inside the throne to press the tab down as it dries, while the second tab will close the throne. Glue the bottom of the throne to the top of the pedestal.

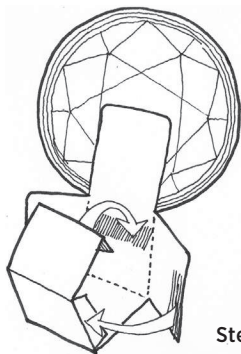

Step 3

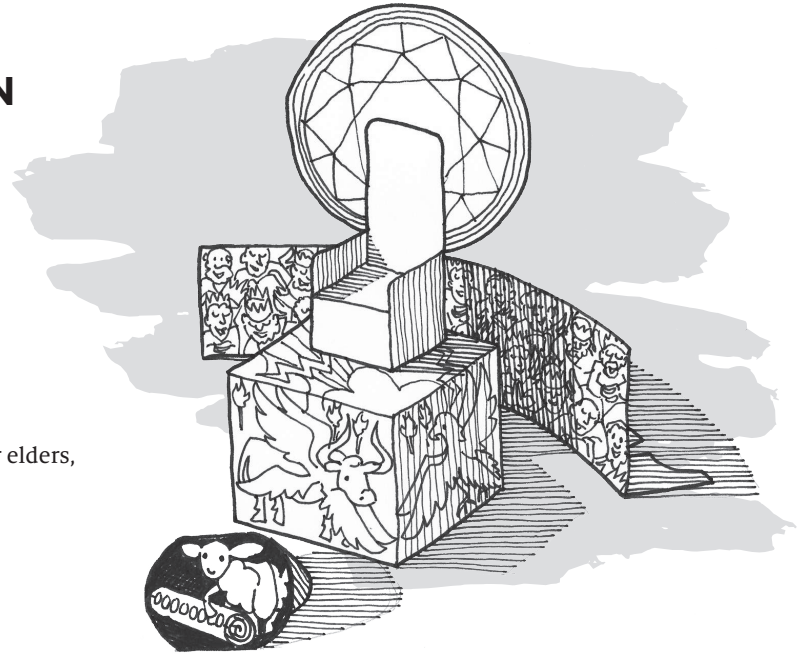

4. Cut out the panel of the twenty-four elders and fold it lengthwise on the long dotted line so that the printed side is out. Crease well, then open the fold 90 degrees. Use scissors to slit the lined panel on each of the six solid lines. Fold the panel with the elders inward on each of the six dotted lines, opening each fold before going on to the next. Arrange the panel so that it stands upright in a semicircle around the back of the throne and pedestal, with the unprinted tabs acting as a stand.

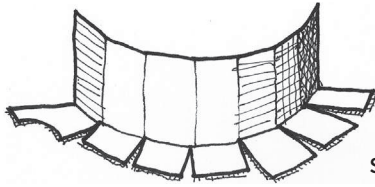

Step 4

5. Fold the lamb panel on the center dotted line and cut it out, watching both sides as you go. Fold the bottom tabs inward and crease well. Now stand the double-sided lamb and scroll near the throne.



Step 5

6. *Optional:* Cut out the illustrated verse and glue it to the back of the elders.

**MAKE IT SIMPLE:** If your craft time is limited, consider making only the lamb and the twenty-four elders. You could also bring the thrones already assembled and let students color the rainbow and emerald parts without crushing the seats and armrests.

**MAKE IT AMAZING:** Make two copies of the double horse template from Craft 41 “God Takes Elijah to Heaven” and color them white, red, black, and “pale,” and assemble them. Add these horses of the apocalypse to your throne-room scene.



To him who sits on the throne and to the Lamb be blessing and honor and glory and might forever and ever!

**REVELATION 5:13 ESV**



square pedestal template

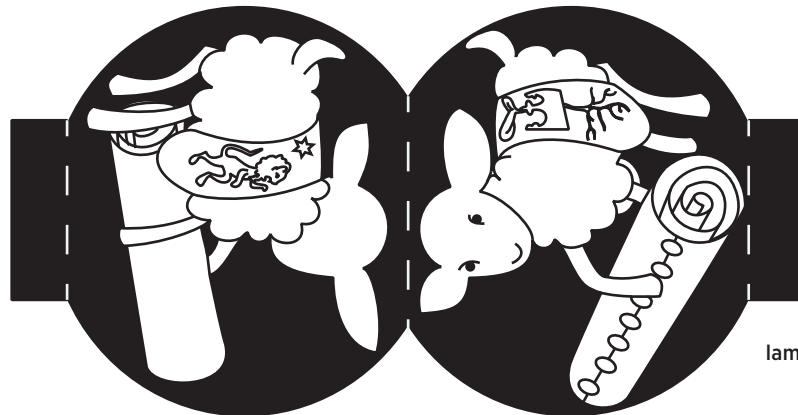

lamb with scroll template

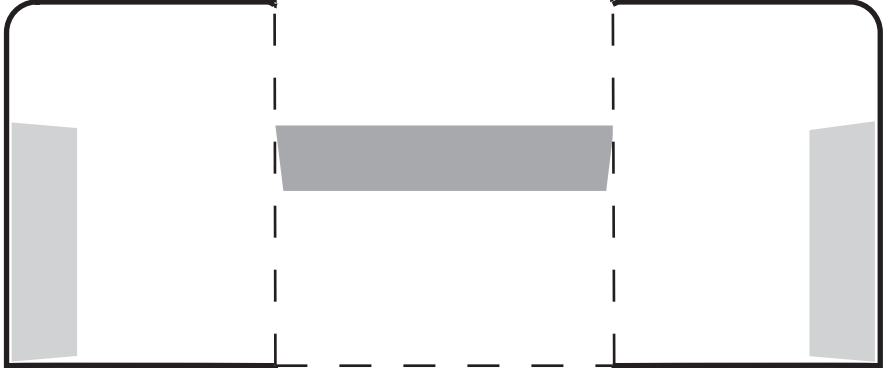
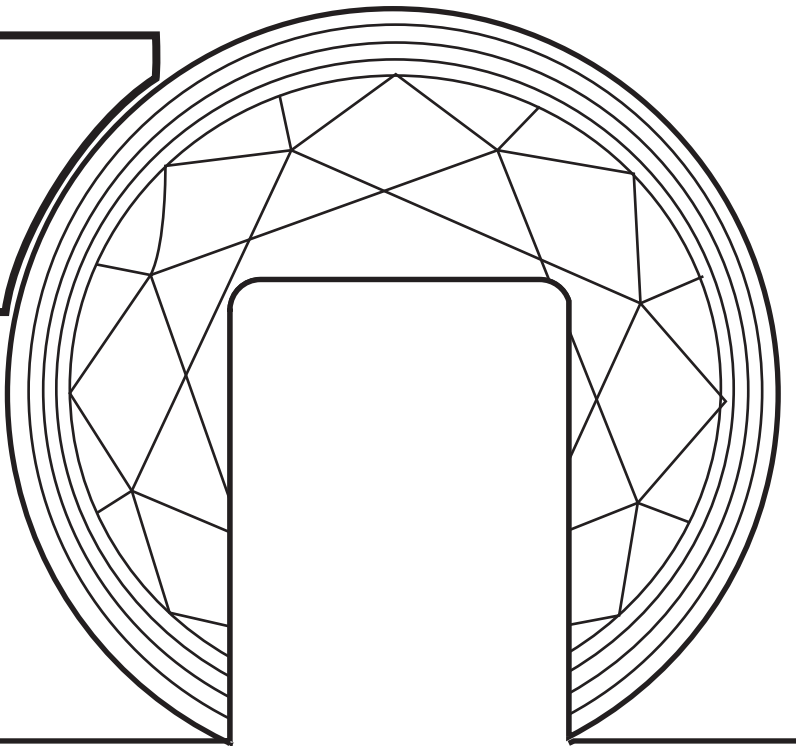
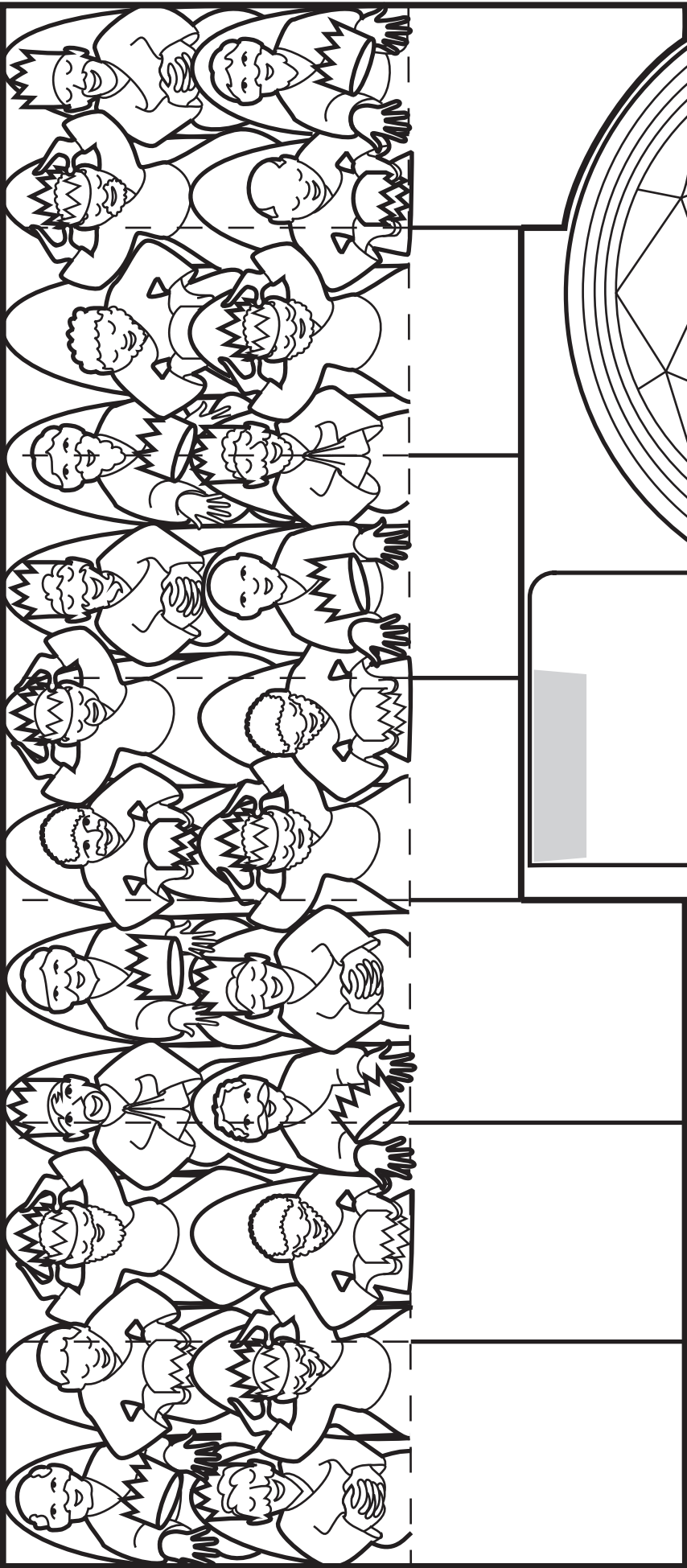

throne template

twenty-four elders template

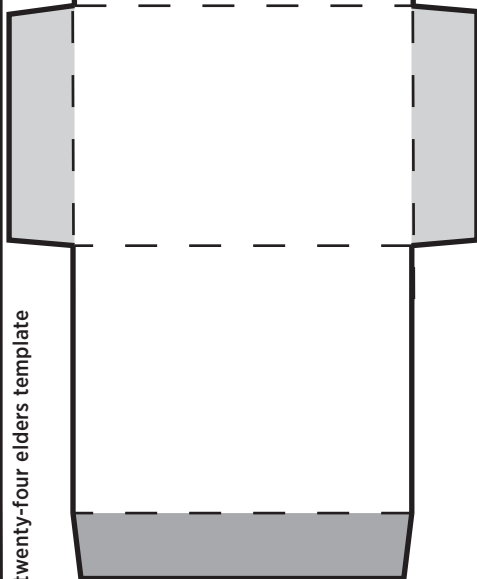



## PHOTO CREDITS AND PERMISSIONS

Unless otherwise indicated below, the artwork featured in this book is taken from David R. Helm, *The Big Picture Story Bible*, illus. Gail Schoonmaker (Wheaton, IL: Crossway, 2004) and the *ESV Big Picture Bible* (Wheaton, IL: Crossway, 2015).

**Craft 1:** Globe image courtesy of VectorTemplates.com,

<http://www.vectortemplates.com/imgtemplate.php?iid=61>.

**Crafts 8:** “Texture of Stone Wall,” stock photo ID: 398155690, used under license from Shutterstock.com, <https://www.shutterstock.com/image-photo/texture-stone-wall-stylish-design-398155690>.

**Craft 11:** “Beige Stone on Stand Background,” stock photo ID: 1170366780, used under license from Shutterstock.com, <https://www.shutterstock.com/image-photo/beige-stone-right-side-sand-background-110366780>.

**Craft 13:** “Retro Metal Bowl” (silver cup), stock photo ID: 203187085, used under license from Shutterstock.com, <https://www.shutterstock.com/image-photo/retro-metal-bowl-isolated-on-white-203187085>.

**Craft 19:** Family with manna and quail illustration reproduced with permission from Douglas Sean O’Donnell, *The Dog’s Dinner*, illus. Gail Schoonmaker (Inverness, Scotland: Christian Focus Publications, 2016), 4.

“White Paper Plate,” stock photo ID: 168551810, used under license from Shutterstock.com, <https://www.shutterstock.com/image-photo/white-paper-plate-isolated-on-background-168551810>.

**Craft 22:** Map image created by author.

**Craft 23:** “Stone,” stock photo ID: 662738599, used under license from Shutterstock.com, <https://www.shutterstock.com/image-illustration/stone-isolated-on-white-3d-illustration-662738599>.

**Craft 36:** “Sea Pebbles,” stock photo ID: 35685361, used under license from Shutterstock.com, <https://www.shutterstock.com/image-photo/sea-pebbles-collection-isolated-on-white-35685361>.

Sling photograph taken by author.

**Craft 40:** “Texture of Stone Wall,” stock photo ID: 398155690, used under license from Shutterstock.com, <https://www.shutterstock.com/image-photo/texture-stone-wall-stylish-design-398155690>.

“Background of Twigs,” stock photo ID: 593169932, used under license from Shutterstock.com, <https://www.shutterstock.com/image-photo/background-twigs-593169932>.

**Craft 44:** “Underwater Blue Ocean Background,” stock photo ID: 510683431, used under license from Shutterstock.com, <https://www.shutterstock.com/image-photo/underwater-blue-ocean-background-sea-510683431>.

**Craft 62:** “Natural Stone,” stock photo ID: 104954471, used under license from Shutterstock.com, <https://www.shutterstock.com/image-photo/natural-stone-isolated-on-white-background-104954471>.

“Stone,” stock photo ID: 662738599, used under license from Shutterstock.com, <https://www.shutterstock.com/image-illustration/stone-isolated-on-white-3d-illustration-662738599>.

“Iron Ore,” stock photo ID: 618074231, used under license from Shutterstock.com, <https://www.shutterstock.com/image-photo/iron-ore-isolated-on-white-background-618074231>.

“Single Natural Stone,” stock photo ID: 560062174, used under license from Shutterstock.com, <https://www.shutterstock.com/image-photo/single-natural-stone-on-white-background-560062174>.

Interior pages of the book of Luke are taken from David R. Helm, *ESV Big Picture Bible* (Wheaton, IL: Crossway, 2015).

**Craft 68:** “Jug” (alabaster jar), stock photo ID: 42303835, used under license from Shutterstock.com, <https://www.shutterstock.com/image-photo/jug-on-white-background-42303835>.

**Craft 69:** “Stone Background,” stock photo ID: 714522316, used under license from Shutterstock.com, <https://www.shutterstock.com/image-photo/background-714522316>.

Woman illustration reproduced by permission from Douglas Sean O’Donnell, *The Dog’s Dinner*, illus. Gail Schoonmaker (Inverness, Scotland: Christian Focus Publications, 2016), 28.



**Craft 72:** “Windblown Sand Background,” stock photo ID: 282792104, used under license from Shutterstock.com, <https://www.shutterstock.com/image-photo/windblown-sand-background-uneven-rippled-surface-282792104>.

“Grunge Background” (stone surface), stock illustration ID: 332814938, used under license from Shutterstock.com, <https://www.shutterstock.com/image-illustration/grunge-background-space-text-image-332814938>.

**Craft 75:** “Unleavened Wheat Cake,” stock photo ID: 47493580, used under license from Shutterstock.com, <https://www.shutterstock.com/image-photo/unleavened-wheat-cake-isolated-over-white-47493580>.

**Craft 76:** “Rotwand/Croda Rossa & Burgstall/Castelliere Mountains, Italy,” stock photo ID: 480808189, used under license from Shutterstock.com, <https://www.shutterstock.com/image-photo/rotwandcroda-rossa-burgstallcastelliere-mountains-seen-trail-480808189>.

**Craft 87:** “White Paper Plate,” stock photo ID: 168551810, used under license from Shutterstock.com, <https://www.shutterstock.com/image-photo/white-paper-plate-isolated-on-background-168551810>.

**Craft 94:** “From Every Nation” illustration reproduced by permission from Douglas Sean O’Donnell, *The Dog’s Dinner*, illus. Gail Schoonmaker (Inverness, Scotland: Christian Focus Publications, 2016), 40.



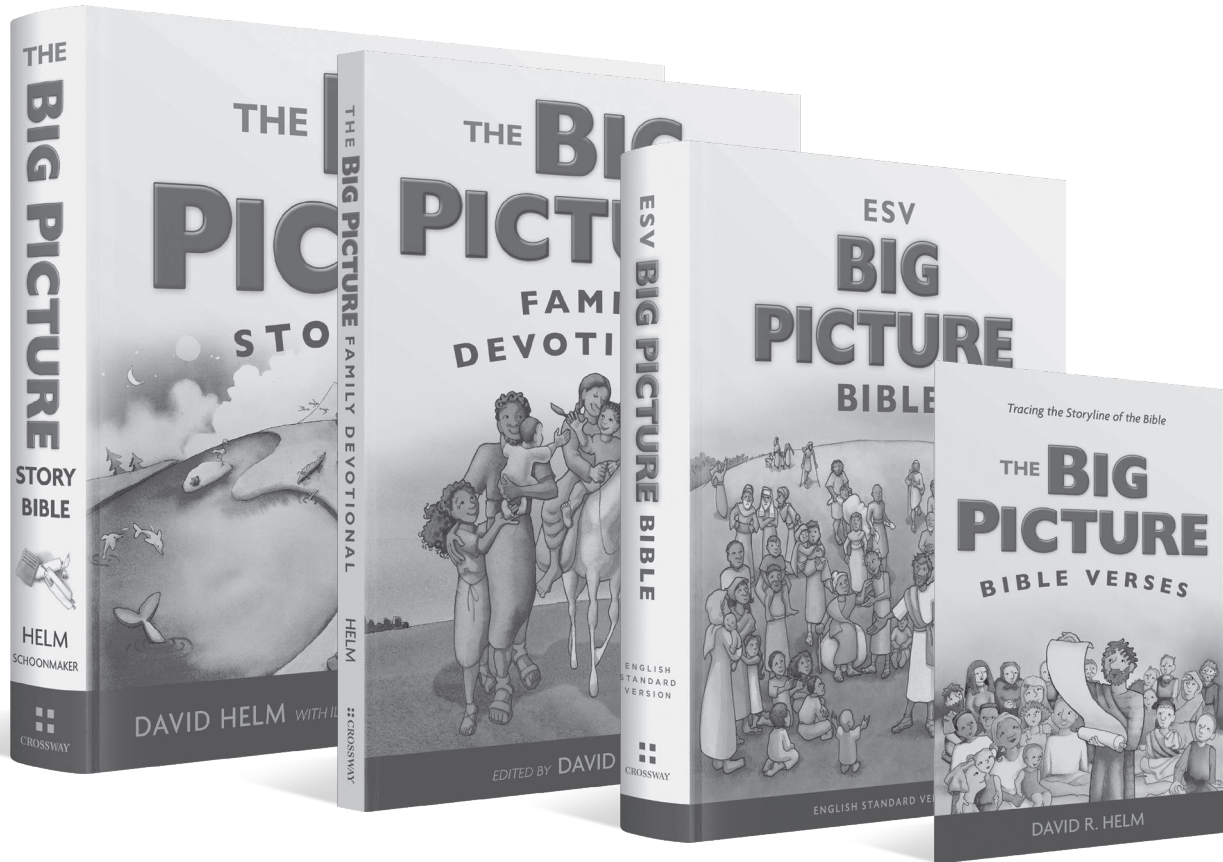

# THE BIG PICTURE SUITE

---

For more information, visit [BigPictureStoryBible.org](http://BigPictureStoryBible.org).



# EASY-TO-MAKE CRAFTS

to help children see the *Big Picture* of the Bible

This book is filled with 101 reproducible crafts suitable for children ages 3–10, each depicting a character, event, or object connected directly to a story in the Bible. Created by the illustrator of the best-selling children's book *The Big Picture Story Bible*, this easy-to-use resource is perfect for reinforcing Bible lessons at church, at school, or at home.

Each craft includes:

- a detailed supply list
- instructions and suggestions for different age groups
- an illustrated memory verse
- a corresponding Bible passage

*“Big Picture Bible Crafts invites children to enter into the story of redemption, experiencing the majesty of God and the beauty of the gospel in a tactile way.”*

**JOEY COCHRAN**, Pastor of Middle School Discipleship and Communication, Calvary Memorial Church, Oak Park, Illinois

*“I love this resource. It takes the biblical stories and makes them come alive in a kaleidoscope of activities designed to engage and stimulate the youngest members of the church community.”*

**IAIN DUGUID**, Professor of Old Testament, Westminster Theological Seminary

*“Big Picture Bible Crafts provides fun and creative crafts to accompany 101 stories from the Bible! Crafts are an easy way for kids to connect with what is taught during a lesson.”*

**HALEY HATAI**, Former Kids' Director, Garden City Church, Santa Clara, California

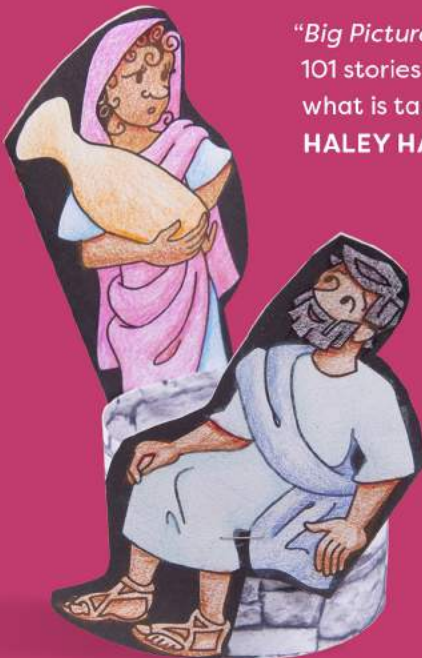

*Gail Schoonmaker* (BA, Wheaton College) is an illustrator and makes her home in Chicago's Hyde Park neighborhood with her husband, Keith, and their four children.

AGES 3–10  
CRAFTS / EDUCATION

 **CROSSWAY**  
crossway.org

